

# Canton Observer & Eccentric

Volume 2 Number 43

Monday, April 5, 1976

Canton, Michigan

26 Pages

Twenty Five Cents

## PUDs under fire after investigation

All planned unit developments (PUDs) in Canton will be under close scrutiny in the coming months in the wake of an investigation by township ordinance officer Bruce Phillips which revealed one developer has failed to meet the obligations of his contract.

Phillips and Supervisor Robert Greenstein have charged Dominic Mocer, developer of the Stonegate subdivision at Lilley and Palmer, with breaking several stipulations in his contract with the township.

Greenstein said he feared that other contracts were being breached, and he has instructed Phillips to look into other PUDs. There are now 18 PUDs in the township comprising 2,878 acres, or about 12 percent of the land in Canton.

When completed, there will be 6,704 homes in the 18 PUDs.

Unlike normal subdivisions, PUDs are not subject to zoning rules and regulations. All guidelines and restrictions are part of a contract the township and the land developer sign.

To alter the PUD agreement, both the builder or developer and the township must agree and sign an amendment.

"THE PROBLEM is that no one has ever really been assigned the job of keeping an eye on the PUDs," Greenstein said.

"No one had the ultimate responsibility of seeing that what was supposed to be done was. Every department in the township had its own little bailiwick, but no one was doing an overview."

"We intend to see that changes."

The investigation of Stonegate began several months ago when homeowners complained of sloppy work and poor service, Phillips explained, and it was at that time he learned that none of the homeowners was aware of the park association.

Each PUD has provisions for a homeowners association that is charged with taking care of the park space. Homeowners are assessed annually for park improvements, and the association determines what improvements and maintenance will be undertaken.

According to Greenstein, one of the major advantages of the PUD—and there are few, he argues—is that the developer must build a park for the homeowners. The size and number of the parks are determined in the contract.

IN RETURN FOR the open space, there is usually a trade-off, and the builder is allowed higher zonings, such as multiple and commercial, in the PUD.

Phillips' investigation into Stonegate revealed that homeowners were unaware of the association, despite being assessed \$25 at closing time.

He also discovered several other violations of the contract.

\*Parks were not graded and seeded prior to construction of homes.

\*Sidewalks along the perimeter of the subdivision were not installed prior to the construction of homes.

\*Maps were not displayed in the sales offices showing that some homes would abut commercial and multiple property.

The major complaint, however, was that homeowners were not aware of the association and therefore were not present at its annual meetings.

At the most recent meeting, about a year ago, in the absence of any homeowners, the association elected officers. Mocer, his attorney, Gil Franklin, and one of the builders in the development, Manuel Dembs, were elected to the board of directors of the association.

After their election, they agreed to charge five cents a month retroactively for the parks to each lot owner.

Assessments went back to the time the first house was sold in November 1973, in accordance with the contract.

THE CONTRACT, however, stipulates every lot owner must pay his share for the park—and at the beginning of the subdivision, most of the lots were owned by

the land developer and the builders to whom he sold the lots.

Greenstein said homeowners purchasing lots and houses in the subdivision had been charged \$25 at the time each sale was closed. But now the developer and builders and all new homeowners will only be charged 60 cents a year, following the vote by the board of directors of the park association.

The upshot, said Greenstein, is that the homeowners have been "ripped off for more than \$20,000 by the developers and builders."

Greenstein charged further that retroactive assessments are illegal and that assessments should have been determined and levied one month after the first sale was made in the subdivision, according to the PUD contract.

Greenstein added that none of the homeowners in the subdivision have been notified of the annual meetings of the park association since 1973.

Franklin said that, since there were so few occupied homes, he didn't believe it necessary to contact the subdivision residents.

"IT DIDN'T SEEM to make sense. According to our records, there were only five homes sold when we held our last meeting. I suppose we should have contacted them, but, under the circumstances, it doesn't seem to make any difference."

Franklin added that he was unaware of the \$25 assessed buyers at the closing of the sales. "It's the first I heard of it," he responded when questioned by the Observer & Eccentric. The builder takes care of that, not us."

As for the 60-cent annual assessments, Franklin said it was his experience that larger levies were unnecessary.

"The park is graded and seeded by the developer. Why should they need so much money for a set of swings or a baseball diamond?"

(Continued on page 3A)

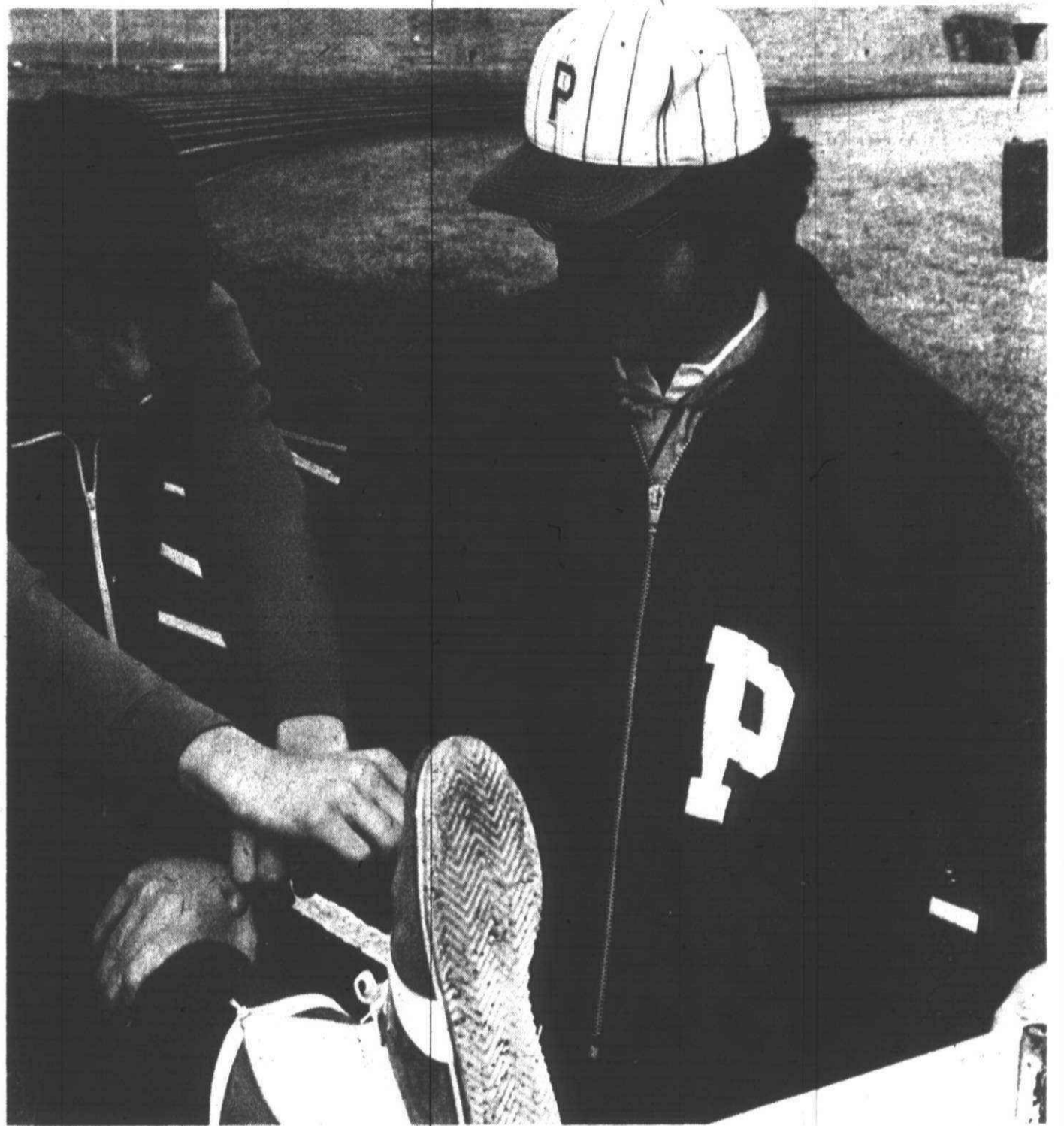

### Loosening up

Salem track coach Gary Balconi gives a few pointers on the finer art of stretching the old hamstrings to Rock hurdler Mike Skone. For a

look at the Rock thinclads' prospects this year, turn to today's sports section. (Staff photo by Gary Gaskey)

## Will voters buy fire assessment district?

By RICHARD GOLD

For the third time in two years, the question of increased fire protection will be before the voters of Canton Township.

But rather than voting May 18 on a specified amount of millage for the construction and staffing of a second fire station, residents will be asked to approve a special assessment district for the purpose of additional fire protection.

That district will include the entire town-

ship, and following a pair of public hearings, the township board will decide on the amount of millage to levy.

Thereafter, each year, the board will determine how much to levy after holding two public hearings.

Under the Michigan law that provides for such a procedure, PA 33 of 1951, the board can levy up to 10 mills without voter approval.

BOARD MEMBERS in favor of going

### analysis

the special assessment route argued last Monday that they lacked the necessary information to ask for a specific amount of millage.

They said it might be better to try for the special assessment district, and then, when all the reports are in, go before the public at the two hearings and ask for an exact amount.

Much of that determination will depend on two reports board members have not received.

The board received a report from the Michigan Fire Chief's Association that suggests a second station is needed in the township, but two studies, one from the Michigan Office of Insurance Services, and one from the Citizen's Advisory Council (CAC), are still outstanding.

The CAC report is expected within the next few weeks, but the insurance report may be some time coming.

An earlier preliminary report issued by the CAC estimated that one mill over 10 years would be sufficient to build and staff a second and eventually a third station.

But members of the administration who pushed for the special assessment said they preferred to wait until all the information is available before asking for a specific amount of millage.

IN THE WAKE of two defeats in 1974, they were understandably apprehensive about asking the voters for a certain amount of money without having the necessary evidence to support a request.

Nonetheless, there was a feeling of urgency about getting the issue before the voters as soon as possible so the fire station could be started this year.

Apparently, there is enough money in the township coffers to construct a second fire station this year if the money can be recouped at the end of the year with an additional mill or two.

In order to collect any additional levy this year, the tax must be on the rolls in August, and township treasurer Carl Parsell said he feared that a millage election in August would be "cutting it too close."

BUT JUST HOW marketable is a special assessment district?

Voters will not know how much money they are approving when they go to the polls; and even though there will be two public hearings, the final decision will lie with the board.

Unlike a specified millage, there is no time limit on the special assessment district. How long the extra millage is levied depends on the township board.

Conversely, Supervisor Robert Greenstein argues that if the board members attempt to levy too much, voters can remove them from office in November.

But what will voters do next year when there is no election to hold over the board members' heads? That might well be a concern.

Greenstein also claims that being able to

review the amount each year is a plus for the voters because they can look at the situation annually, and they can hold their officials accountable.

Once passed, however, the board cannot be held accountable for a specified millage. "With the assessment district, we have to justify our expenditures every year," the supervisor argued.

PERHAPS THE KEY to any vote depends on the faith the people have in their elected officials.

As Clerk John Flodin said, "A responsible board will assess only the monies needed."

The question then becomes, "Do the voters of Canton think their board will be reasonable?"

Flodin later added that the board had better give the people an indication of the limit they intend to ask for when reports are in. "We have to say something like 'We won't go over 1.5 or 2 mills,'" the clerk explained, "or I don't think this thing has much of a chance."

Already, because of lack of information, there has been some discrepancy over the estimates of what is needed. While the CAC has suggested one mill in its preliminary report, the township administration has estimated 1.5 mills is probably closer to the actual need.

Regardless of the amount the board eventually decides on, the fact that it is the board and not the people making the final decision in the amount has probably made the special assessment district less palatable to the voters than a specific millage.

Some trustees have refused to vote for payment of the bills in recent weeks, charging that bidding procedures are not

being followed and that money is being spent improperly.

HOW FAR that feeling trickles down to the voters should have considerable impact on the May 18 vote.

Perhaps it might have been wiser for the board to ask for a specific millage—maybe as high as 2 mills—with the understanding that if less is needed, less will be collected.

Just how marketable the special assessment district is remains to be seen—and on May 18 the answers should be available.

And if the people vote yes, with the knowledge that in most instances the Greenstein administration has four votes on a board of seven, that affirmation could mean more than the people desire for additional fire protection.

It could be interpreted as a vote of confidence for the present administration.

## Gridders back coach

By BILL COLLINS

Plymouth Canton football players have given their unanimous support to the high school's varsity football coach, Jim Muneio, and his three assistants, all of whom resigned last Monday.

Although the resignations had not been submitted in writing to the Plymouth Board of Education as of Friday, the coaching staff and the board are scheduled to meet in a closed session preceding the Monday, April 12, school board meeting.

The resignations were prompted by pressure during the last two years from school board trustee Joe Gray and parents of the players.

Junior John Young, next fall's team captain, organized a meeting of the players Friday morning to discuss the resignations. Included in the meeting were players in all grades who will be participating in the Canton football program in the upcoming season.

OF 48 STUDENTS attending the meeting, there were 12 returning lettermen from the 1975 season and 25 varsity candidates. All of this year's seniors were excluded from the meeting, according to Young.

"The fact that the varsity coaches resigned was the main reason for the meeting," said Young. He added that there was a lack of communication among the players concerning why the coaching staff resigned.

"Most of the team members I talked to said they didn't want the coaches out, so I called the meeting to see if all the kids possibly could get behind the coaches," explained Young.

"Some of the players weren't sure of what was going on. They were making up their minds on hearsay, but after we dis-

cussed the problem as a team, everything was cleared up," said Young.

DURING THE MEETING, players who had not supported Muneio as a coach listened while differing views of the problem were presented. Although some disagreed with the way Muneio ran the ballclub, team representatives said all members would play for him.

"After everyone had discussed the problem, there wasn't a person who wouldn't play for Mr. Muneio," Young said.

The team effort was gratifying to Muneio. "I appreciated their efforts in what they are doing at this time. My only concern is the effect it has on the reactions of people," said Muneio.

Canton assistant coach Jim Jarvey wanted some time to think about the player's mandate.

"IT'S TOO IMPORTANT a thing to make a quick decision on, there's some things we (coaching staff) are going to

have to sit down and talk about," he said.

Coach Muneio said he probably would be turning in his resignation sometime this week. One member of the varsity staff reportedly has submitted his reason for stepping down in writing.

If a written resignation is submitted by Muneio this week, follow-up resignations are expected from junior varsity coaches Tom Garrett and Russ Carlson, plus freshmen coaches Sam Daas and John Campbell in addition to varsity assistants.

Muneio has made it his policy not to approach other coaches to solicit their support, letting other coaches make their own decisions and thus winning the approval of the Canton coaching staff.

"This man is dedicated to working with kids and getting involved in the program," said Garrett. "JV and frosh ballplayers are coming into the varsity system. That really makes a difference in the program; however, I am not planning on coaching next season."



### It's official!

Charles Zazula (left) presented Canton Township Bicentennial Commission members Dominic Cirino and Lauren Buerhle with a document officially qualifying the township as a bicentennial community. Canton also received a national bicentennial flag from the Area Bicentennial Commission ceremonies in the Plymouth Cultural Center. (Staff photo by Gary Caskey)

### inside

Amusements 4B  
Brevities 9A  
Classified Want Ads Sec. C  
Death Notices 1C  
Plymouth Life 1B  
Sports 6A  
Stroller 10A  
Where There's Life 4B

### ONCE UPON A MATTRESS

Centennial Education Park will present the hit play "Once Upon a Mattress" to theatre-goers starting April 9. For a sneak preview of the performance, turn to page 10A.

# What profiteth a man...

## To gain world and lose his sole?

By W.W. EDGAR

Little Pete Mucci, the popular shoe repairman who has been holding forth in his shop at the central parking lot for the past 15 years, heaved a heavy sigh as he recounted the many changes that have been made in his profession in the past decade.

There was a day when Pete and his fellow cobblers, spent most of their time cutting soles from large pieces of leather and then either nailing them or sewing them on the shoe top. But no more.

"Leather is too expensive," Pete said, while shaking his head in disbelief that any commodity could rise that much. "I

used to charge only \$2.75 to put new soles and heels on shoes; not any more. The price now has jumped almost four times."

PETE ALSO noted that the high price of leather has had a major effect on the show business—even at the factory.

"Factory now uses crepe and rubber, and now we don't nail and sew any more. Now we vulcanize with special cement.

"It's lots different than it used to be, and people don't get shoes repaired much anymore. When the crepe goes, the shoe goes, too."

Pete hates to think of the future—insofar as shoe repairing is concerned.

"There used to a lot of us," he pointed out, "but many quit because prices got too high for profit. They can make more working in the factory."

Pete called attention not only to the high wages in the shops but to the many fringe benefits now available that a cobbler can't get on his own.

Pete, who was born in Italy, was 20 years old when he came to America with his parents who settled in Detroit. He had a shoe repair shop there for awhile and still smiles when he recalls the reason he came to Plymouth.

"One day a salesman came to our shop

and told me about Plymouth and that it looked like a good place to open up a shop. So I came and have been here 15 years."

With a smile, Pete asked, "Do you know what became of the salesman? He's retired and I'm still here."

Pete says Plymouth and its people have been good to him, but he doesn't know how much longer he can stick it out with the high price of leather and the changes in the shoe repair business.

While he doesn't admit it, he fears that cobblers are on the way to oblivion along with the blacksmiths of another day.

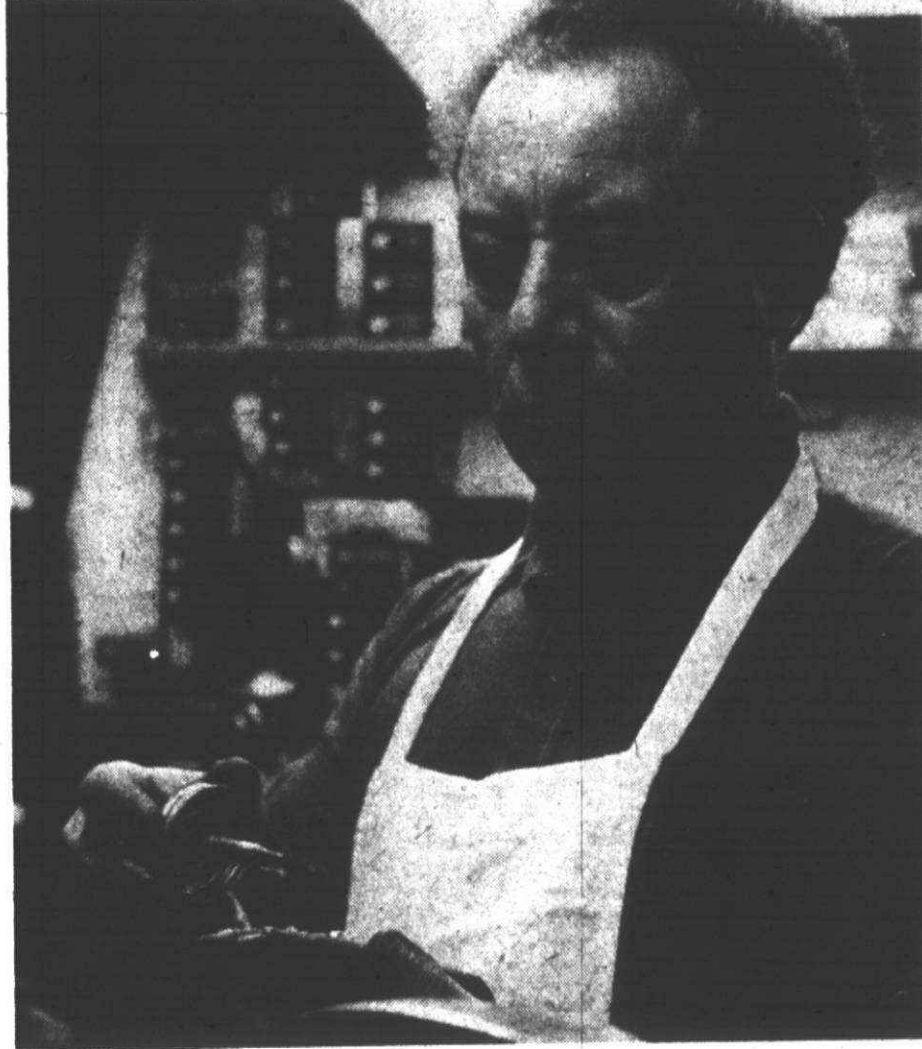

Pete Mucci works on a pair of soles while talking about the many changes in the profession of a cobbler. (Staff photo by Garry Caskey)

WILTON <sup>RWP</sup> ARMETALE

Sand Molding Demonstration

Thursday, April 8th  
12 to 3 and 6:30 to 8:30 P.M.  
Wiggs China Shop

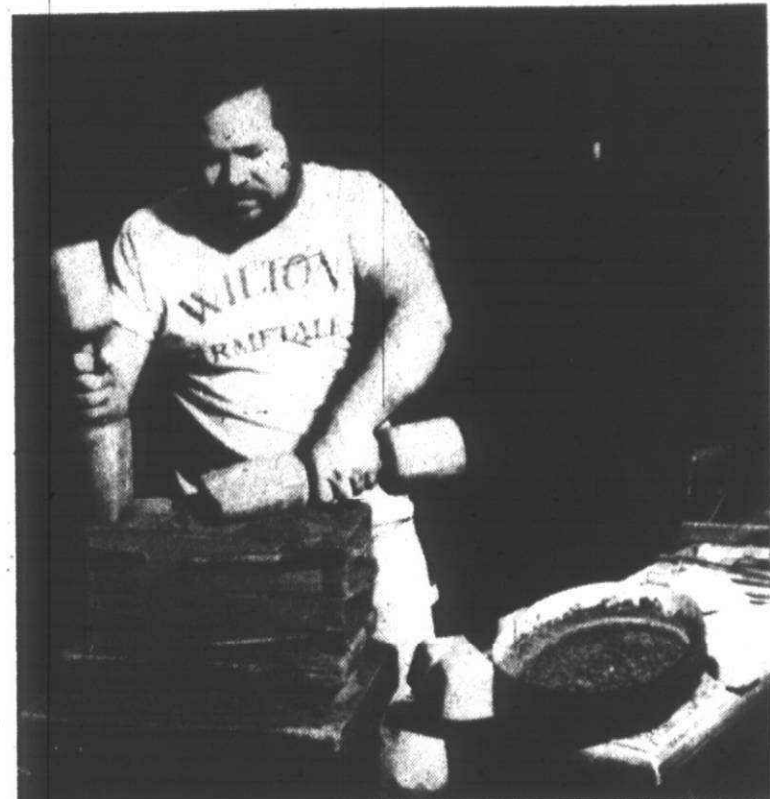

Pat Sterner, Wilton Armetale Molder

Forming metal from a sand mold is one of the oldest crafts known to man. Its origin traces back to the early Egyptian Dynasties. Today, that same ancient process is still in use at the Wilton Foundries to make the Armetale metal dinnerware & giftware.

We're very fortunate to have Pat Sterner demonstrate this fine sand molding craft in our China Shop Thursday afternoon and evening. Pat works with special hand tools, rare sand and metal fired to its melting point and poured into the mold.

Come to Wiggs and watch Pat make the finished product. He'll be happy to answer any questions and explain his craft while working in his foundry. Make your selections from our fine collection.

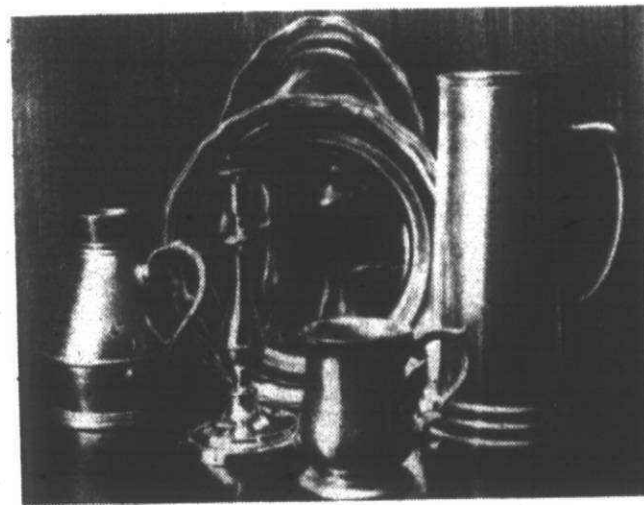

Armetale dinnerware and serving pieces have the look and feel of traditional pewter... but with very special features. Armetale won't chip, crack or break. You can cook on it, eat and drink from it... it's completely non-toxic. Every piece is individually cast and painstakingly finished. Come in and see our extensive Armetale collection.

WIGGS  
Since 1944



4080 TELEGRAPH RD. (at Long Lake Rd.)  
BLOOMFIELD HILLS • 644-7470  
open Mon., Thurs. & Fri. 'til 9

### OWENS LANDSCAPING

Located in Livonia  
Call 464-0832

Monday thru Friday 8 a.m. to 5 p.m.

COMMERCIAL & BUSINESS

- ★ Lawn Maintenance
- ★ Complete Service
- ★ Contracts Available
- ★ Commercial and Industrial
- ★ Apartments and Condominiums
- ★ Factories, Large Area Cuttings
- ★ Field Mowing
- ★ Cemetery Maintenance



Wind down  
your day  
in a  
delightful way  
at

The  
Jolly Miller  
Lounge  
in the  
Plymouth  
Hilton Inn

Relaxing cocktail entertainment  
4:30-8:30 P.M., Monday-Friday

Followed by the sounds of

"JOHNNY MICHAELS  
&  
SERENITY"

for your dancing pleasure:

Monday-Thursday 8:30 P.M.-1:30 A.M.  
Friday & Saturday 9:00 P.M.-2:00 A.M.

The Plymouth Hilton Inn

5-Mile & Northville Roads  
Plymouth, Michigan 48170



WSDP RADIO  
89.3

Community  
radio listings

Following are this week's program listings for WSDP-fm (89.3 on the dial), the student-operated radio station at the Plymouth Centennial Educational Park.

April 6—At 2:05 p.m. a production by first and second graders of Miller Elementary of an adaption of "Hansel and Gretel." The organizing teacher is Ron Zang and the title is "A Play." At 1:05 p.m. is "A Story"—this week's story being "The Cat and Mouse Who Share a House."

April 7—At 4:30 p.m., "A Play"—same as Tuesday.

April 8—At 5:11 p.m., "A Story"—same as Tuesday. This is brought to you by Mrs. Pat Thomas and the Dunning-Hough Library. At 5:30 p.m. is "Praas"—a continuing adventure series aired Tuesday and Friday.

Remember: The Homework Show can be heard each Monday when there isn't a school board meeting, from 6-10 p.m.

COME ON OVER TO OUR HOUSE!  
Michigan's  
Largest  
Ethan Allen Dealer...

the Hearthside  
LIVONIA  
UTICA • SOUTHFIELD

the good stuff  
store



Maggie's  
of  
Livonia  
preview  
opening

FIRST IN LADIES APPAREL

Specializing in Large Sizes

6-20—12 1/2-24—32-52

19017 Farmington Road • 474-5354

and Next to Genson's Hair Fashions



Roma's

We're still changing for the better,  
because the emphasis has always been on you.

Roma Halls started over 30 years ago as a small family catering firm in Detroit. Over the years we've grown to become one of the most successful. The reason for our success is simple: we've always given our customers the kind of personalized service that others have forgotten about.

We're now the largest caterer in the Metro Detroit area, but we're not content with just being the largest. We've made so many changes in the past three months that what used to be known as Roma Hall is a whole new concept, and we're now doing business under the name of Roma's.

We've added many new features with you in mind. For example, all our banquet rooms have been recently remodeled in an elegant style you may never have thought imaginable. We've added chefs to our staff to give your party that uniqueness you desire.

Whether your function is a dance, a reception, a luncheon, or any other type of occasion, one of our five facilities can accommodate your party of any size. Call or stop by one of our offices and see what Roma's can do for you...

Roma's of Livonia  
27777 Schoolcraft  
just west of Inkster  
427-1990

Roma's of Garden City  
32550 Cherry Hill  
bet. Merriman & Venoy  
425-1430

Roma's of Bloomfield  
332-3297

Roma's of East Detroit  
778-7750

... and our newest, opening in May  
Roma's of Ann Arbor

761-4262

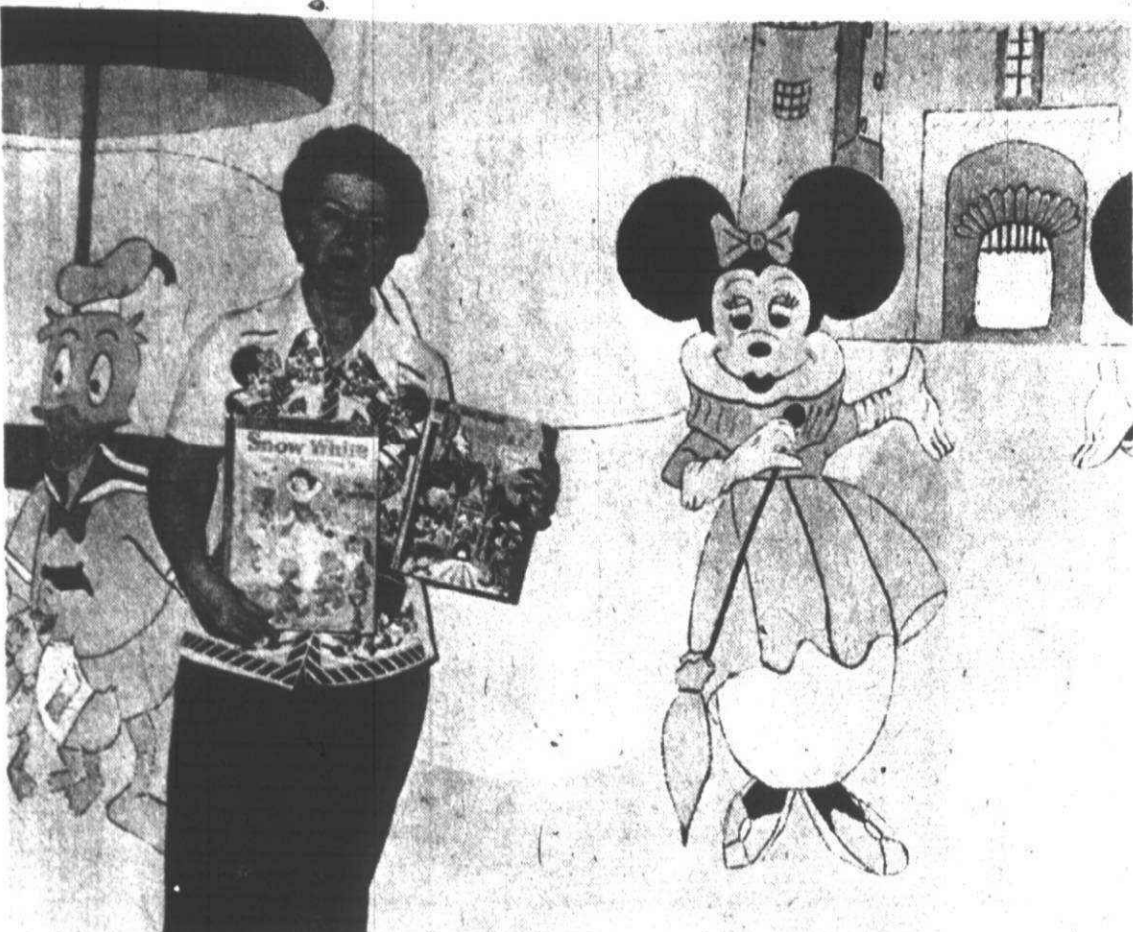

### Disney dizziness

Nick and Lois Benson of Canton and daughter Kim got hit with the Disney bug this winter and went mural-crazy, covering their entire basement with pictures of the great film producers cartoon characters. Cost of the project was a mere \$30 as Lois drew and Nick painted. The idea? It was Kim's. (Staff photo by Gary Caskey)



## Board approves new water rate structure

Following action by the township board Monday night, the majority of water users in Canton will be paying less on their quarterly bills.

Using the recommendations of the their auditing firm, Seidman and Seidman, members of the township board approved a rate restructuring that will benefit 56 per cent of the users in the township.

Large users, primarily commercial, however, can expect an increase in their bills, although the increase will not exceed eight per cent.

The new system features a two-tier structure, with water customers charged one amount per 1,000 gallons for the first 100,000, and a smaller rate per 1,000 for anything above the first 100,000.

Large users will be billed monthly as in the past, while smaller users, both residential and commercial, will be billed quarterly.

Under the old rate structure, commercial accounts, regardless of size, were billed monthly under a five-tier rate structure that resulted in very large users re-

ceiving water from the township for less than Canton paid.

WHILE BOARD members approved Seidman and Seidman's recommendations, they tacked on a six per cent increase to defray the eventual costs of depreciation on the system.

The maximum increase in rates under Seidman's recommendations is eight per cent without the additional six per cent passed by the board, but tap in rates for new customers will rise dramatically.

Capital charges will increase anywhere from \$45 per customer to \$350 depending on the size of pipe used.

Without the additional six per cent charge, the new rates as approved are:

- 54 cents per 1,000 gallons with a proposed 39 per cent increase from Detroit.
- 65 cents per 1,000 gallons without a 39 per cent increase from Detroit.
- For large users, water will cost 27 cents per 1,000 for usage above 100,000 gallons without the proposed increase and 37 cents per 1,000 with it.
- Sewer use will cost 35 cents per 1,000

gallons of water used with or without the Detroit increase for the first 100,000 gallons.

•Above 100,000 gallons of water used, sewer will cost 16 cents per 1,000 gallons with or without the Detroit increase.

UNDER THE OLD rate structure, sewer rates were computed on the basis of water usage with customers billed 150 per cent of their water usage to determine a sewer charge.

The new rate structure will also feature a lower minimum amount of 5,000 gallons per billing period.

Under the old system, the minimum charge per billing period was 10,000 gallons regardless of usage.

According to Seidman and Seidman, the new rate structure is more equitable, with all users paying their fair share of the operational and amortization cost of the sewer and water system.

Although there was some discussion about tacking on the additional six per cent charge, the board passed the measure 6-1 with trustee board Schwall dissenting.

after Bob Wiar, Seidman and Seidman representative, explained that some money was needed to cover depreciation of the system in later years.

Parsell, who asked for the six per cent,

argued that a new rate increase would be necessary within a few years without the additional six per cent and that he said "would be intolerable."

"We have to have a secure system," the

treasurer added, "and unless we charge an extra six per cent, we'll be at a break-even point. In later years, when parts of the system need to be replaced, we won't have the money available."

## Township investigates PUDs

(Continued from page 1A)

"Our experience in Pickwick was that they had so much money they didn't know what to do with it. When the residents get control of the homeowner's association and they want to assess themselves a lot of money, that's their business."

Greenstein said he will mail a letter to Franklin and Mocerri and give them 30 days to respond to the township's demands.

"WE HAVE THREE options open to us," he said. "We can stop occupancy permits, but that may hurt the people as well; we can stop all building permits; or we can void the PUD contract by declaratory judgement in court."

"I've talked to our attorney, Bert Burgoyne, and he says the contract is like any other, and if they violate it, we can void it."

"But we really don't want to put them out of business. Shutting them down is like hitting a giant with a howitzer. We'd rather see that they correct the situation."

"But if they don't respond, we will be forced to take some action."

The broader concern is the other 17 PUDs, with the exception of Carriage Hills and Windsor Park which are for the most part completed.

"All the other PUDs may be in the same position, and we intend to check them out."

"We've been dealing with Canton for a number of years," Franklin said, "and I

don't know why they don't come to us first to see if we can work out the problem rather than making accusations in the papers."

"We're willing to work things out, but instead they seem to want to make this an adversary proceeding."

Franklin added that while Mocerri's name was on the PUD contract, the responsibility to meet the terms of the contract had, in many instances, been passed on to the builders to whom Mocerri had sold the lots. "We have no control over what they do," he said.

Stonagate homeowners will be meeting in the future with Franklin, Mocerri, the builders and township officials to determine a course of action.

## Sketchbook available at museum

The first edition of "The Heritage of the Plymouth Area," a collection of sketches created by members of the Three Cities Art Club, will be available for the first time Sunday, April 4, in the Plymouth Historical Museum.

To commemorate the occasion, the artists whose works appear in the book will be honored by a short reception and an exhibit of original sketches appearing in the book.

Those purchasing the books on Sunday will have an opportunity to meet the artists and have their copies autographed. All proceeds from the sale of the sketchbook will go to the museum.

By the time the project was completed, it had become a total community effort, according to Lorene Vives, project coordinator.

The artists contributed their art as a bi-centennial project to aid the museum.

They contacted area residents for old photos showing scenes which have disappeared from the Plymouth landscape. They also used the collections of the museum and archives as a source for their sketches.

Art suppliers, gallery owners, and other businesspeople contributed financial support. The Frame Works in Forest Place Mall donated the matting for the exhibit in the museum.



Plymouth Canton and Salem high school students attended their second anti-smoking workshop preparing to adopt the Bentley Project which has received national recognition. Participants included (seated, from left) Nancy

Cole and Steve Seippel, (standing, from left) Mary Williams, Mike Skinner, Matt Norris, Mike Bosche, Rick Shepherd and Jill Ochalek and Area Coordinator Jerry Barker. (Staff photo)

## Students fight smoke

Some 26 students from Plymouth Salem and Plymouth Canton high schools have signed up to spread the gospel of anti-smoking to elementary pupils throughout the Plymouth Community School District.

The students have already had two workshops and have contacted elementary school principals who have promised cooperation. The anti-smoking program is expected to get under way within three weeks when the students receive their instructional material.

THE STUDENTS AT the Plymouth Centennial Educational Park are getting involved in a program called the Bentley Project—an effort which began in Livonia Bentley High and is now being implemented statewide with assistance from Schoolcraft College and the American Cancer Society.

Jerry Barker, area coordinator and director of student affairs at the CEP, has helped coordinate the program here, with assistance from Bentley students. Acting as advisors have been Tom Crowley, director of respirator therapy at Sinai Hospital in Detroit, Linda McNeal, volunteer youth chairman for Plymouth Canton High, and Valerie Lafferty of the Wayne County Chapter of the Michigan Cancer Society.

From its Bentley beginnings, the program has spread to Stevens and Churchill high schools in Livonia, Redford Union High, Crestwood High in Dearborn Heights, Northville High, the Wayne-Westland School District, and now to Salem and Canton high schools.

Michigan to help pupils decide not to smoke.

Part of the funding to help spread the program across the state comes from \$2,645 contributed by the Schoolcraft campus Jaycee group.

AS THE BENTLEY project works, members of the teams are chosen at the beginning of each school year.

After training, they make scheduled visits to every elementary school in the district once during the year, sending two students into every classroom.

"We tell the kids all the good things about not smoking," explains Jill Ochalek, third member of her family on the Bentley team. "We show them we are people who are so involved in activities at school, and through other organizations, that we don't have to smoke. And we seem to get a lot of response. The children write us letters and send us pictures, and we hope we are getting across the message."

## Smith sponsors law on legals

State Rep. Roy Smith (R-Ann Arbor), whose district includes Plymouth, has sponsored a bill aimed at reducing the publication expense of Michigan's 83 counties.

The measure, HB 4378, eliminates the requirement that counties publish an itemized report of receipts and expenditures in local newspapers.

Counties are the only unit of government required to do this because of an antiquated statute, says Smith. "In fact, this law is so conflicting, it requires counties without auditors to publish and those with auditors aren't required to publish."

If it becomes law, Washtenaw County is expected to save some \$14,000 annually in

MEMBERSHIP ON the team is a prestige thing at Bentley.

During the third year of the program, there were some 70 applications for a dozen openings.

Principal Zack comments: "These are the kind of people with whom the younger children can identify, and they are the ones who can offer an example to resist the peer pressure to smoke."

"This is the only sustained, aggressive effort against smoking, and it's the only kind of effort that can work. It's obvious, from the number of people who do smoke despite medical warnings, that if you wait until kids are in junior high or high school, it's too late."

Shirley Romeyn, public education director of the American Cancer Society, adds: "Young people aren't worried about the medical aspects of smoking. That danger is a long way off. That's why we hardly ever send physicians into classrooms. An older student, obviously enjoying life without smoking, can say it much better."

publication expense. Another 36 counties which responded to a questionnaire sent by Smith, said they would save \$142,000 annually.

"Most county officials have felt for a long time, and I agree with them, that publishing that long list of itemized receipts and expenditures every month was an unnecessary expense because most of it was so complicated that it would take a trained accountant to figure out. This doesn't, however, remove the requirement that the minutes of the commissioners meetings be published and in so doing, a summary of the receipts and expenditures can be published."

**BONNIE-LO**

930 W. Ann Arbor Trail, Plymouth 453-7674

Government Approved Drugs

WE ACCEPT U.S.D.A. FOOD STAMPS

Registered Pharmacist On Duty

**Union Insurance Prescription Program**

**Maximum Customer Co-Payments 67¢ Only**

---

**Wilson's Low Fat Milk**

2 1/2-Gallon Cartons **89¢**

**Borden's Glacier Club Ice Cream**

1/2-Gallon Carton **69¢**

---

**Ingraham Electric Clocks**

•Sweep Second Hand •Unique Sculptured Design •Shatterproof Crystal

**2<sup>99</sup>**

**Regular or 1-Calorie Vernors**

3 28-oz. Bottles **1<sup>00</sup>**

---

**Bonus Coupon Save 1.00**

**Gillette Disposable Cricket Butane Lighter**

Each **69¢**

**Bonus Coupon Save 60¢**

**Micrin Plus Mouthwash**

32-oz. Bottle **89¢**

**Bonus Coupon Save 40¢**

**Liquid Woolite Cold Water Wash**

16-oz. Plastic **1<sup>09</sup>**

**Bonus Coupon Save 60¢**

**Chocolate M & M Candies**

12-oz. Pkg. **79¢**

**Bonus Coupon Save 1.00**

**One-A-Day Vitamins With Iron**

100-ct. Bottle **2<sup>29</sup>**

**Bonus Coupon Save 60¢**

**SCHICK Platinum Plus Double Edge Blades**

5-Blade Pkg. **29¢**

**Bonus Coupon Save 80¢**

**Datril Pain Reliever Safe Non-Aspirin**

100-ct. Bottle **59¢**

**Bonus Coupon Save 18¢**

**Swan Isopropyl Rubbing Alcohol**

16-oz. Plastic **24¢**

Limit 2 Per Family Expires Sat., Apr. 10th. \*Coupon Good Only At Bonnie L.

Rights Reserved to Limit Quantities • No Sales To Dealers

Prices Effective Thru Sat., Apr. 10th.

**Clip & Save**  
**The VILLAGE STRIPPER IS OPEN**  
 FURNITURE STRIPPING  
 Wood **455-3141** Metal  
 10-4 140 E. LIBERTY  
 Tues.-Sat. OLD VILLAGE, PLYMOUTH  
**10%**

**Holy Communion Pictures**  
 Let us help you save the day forever. Call soon for appointment.  
**Gaffield STUDIO PHOTOGRAPHY**  
 600 West Ann Arbor Trail  
**GL 3-4181**  
 Downtown Plymouth

**THRU APRIL SPECIAL ON DISC & DRUM BRAKES**  
 ON MOST CARS  
 DISC **\$60.90**  
 DRUM **\$47.80**  
 LABOR & PARTS INCLUDED  
**HOSKIN GULF**  
 45230 MICHIGAN AVE.  
 CORNER OF CANTON CENTER RD.  
**721-0650**

**NOW IS THE TIME for DORMANT SPRAY**  
**PLANTING SUPPLIES**  
 SEEDS • PEAT POTS  
 PEAT CUBES • RED-EARTH  
 • POTTING SOIL  
 • PLANT TRAYS • VERMICULITE  
 PERLITE  
 PLANT FOODS • GRO-LITE BULBS  
**SAXTONS GARDEN center inc.**  
 587 W. ANN ARBOR TR. PLYMOUTH 453-6250  
 DAILY 9:00 - FRI 9:00 - SAT 9:00

# Aid on the way for W-W

By MARILYN FITCHETT

Wayne-Westland Supt. Timothy Dyer is hoping ground-breaking ceremonies for a new vocational education center will be held at this time next year.  
 Dyer received word last week that Gov. William Milliken has signed into law a bill permitting districts with student populations of 18,000 to participate on a 50-50 basis with the state for both the constructing and equipping of a vocational education center. Wayne-Westland, which now qualifies, is anticipating funding of up to \$1.5 million from the state.  
 Similar legislation has permitted districts of 30,000 students to participate in a matching fund program for vocational education, but only four districts in the state qualified.

**IN ORDER TO RAISE** the matching funds for the center, Dyer said the district will probably seek bonding approval from the residents this fall or winter.  
 "We definitely will not be holding a bond election in June," Dyer said. "It would be most prudent if we waited."  
 "There are a number of steps we have to go through before we are officially designated as a vocational education area. And that takes time."  
 "If we're successful with a bond proposal, I'd expect a hole being dug this time next year."

Dyer said the center would be built independently of any existing school buildings, but possibly would be on a present school site.  
 "We don't have a lot of property but we do own some. There is property at both the John Glenn and the Wayne Memorial sites, and we have vacant land between the schools."  
**WITH THE VOCATIONAL** center, the district will expand its present programs and introduce programs it has not been able to offer before.  
 "With a student population in which the vast majority of our students do not go on to higher education, vocational education has to be a major thrust for this district," Dyer said.  
 "It's our responsibility to train our young men and women for the world of work, to give them skills and entry level ability that will permit them to secure jobs in today's tight economic market."  
 Dyer said the district would be able to upgrade present programs such as its auto and bump shop classes and child care and nursing classes.  
 "We just don't have the room to teach these programs the way we'd like to see them being taught."  
 Other classes which the district would be able to offer are welding, large and small appliance repair, commercial art, dental technology and graphic arts.  
 "These are very marketable areas that we haven't been able to get into," Dyer said.

**ASIDE FROM THE** vocational education aspects, Dyer sees some overlapping benefits for the district.  
 "The program offered after the center is built will be for high school students and adults."  
 "We hope to be operating a heavily expanded night school program."  
 Not only will more of the community be able to use the facilities, which would

make it a more attractive bond package when the district goes to the polls, but the district also has been able to maintain a steady enrollment thanks to its night school programs.  
 "We feel we'll be losing about 400 students in the elementary grades, but we hope to make that up in adult education," Dyer said.  
 Because of its "aggressive" adult programming, the district counts 1,000 adults as full-time students. At present, most school officials contend that present school aid formulas discriminate against districts with declining enrollments.

**SPECIAL EDUCATION** students would also be able to make use of the vocational center, according to the Dyer plan.

"If we have vocational education equipment that can be used for special ed students, we would be eligible for a direct grant from the federal government," Dyer said.  
 "It would be possible for us to have machinery installed which could be lowered for wheelchair students. The equipment would be expensive but there would be an overlapping of the vocational and special ed areas."  
 When the district seeks bonding approval, Dyer said many of the special education components of the two defeated bond issues would be included.  
 "We have never felt that the ingredients of our bond elections have been the real problem," Dyer said.



Don Elliott of Miller Elementary gets in the spirit of energy month by remembering to turn off the lights when leaving the room. (Staff photo by Gary Caskey)

## Energy savings stressed in April

April has been declared energy conservation month for the Plymouth Community Schools.  
 A district-wide effort to save energy and promote energy conservation is planned by the school district's energy conservation committee.  
 "Budgets for utilities have increased by more than 25 per cent year for the last two years with projections indicating similar rises in the future," says Gerald Voltrath and James Symonds, co-chairmen of the committee.  
 "Dollars needlessly spent on heating fuel, electricity, water, and telephones must be taken directly from the educational dollars available."  
 Each school building will develop a conservation program involving staff and students. Maintenance staff will adjust me-

chanical systems to develop optimum energy efficiency for each building.  
 Plymouth Salem High has developed a slide-tape presentation on energy saving which will be circulated to each school.  
 Projects will include posters, radio spot announcements, contests, dramatizations, and student reports.

**RUTH'S Pennyrich** BRAS  
 IN DOLL HOUSE BRIDALS  
 2806 S. PLYMOUTH ROAD  
 LIVONIA 525-5243  
 2 BLKS EAST OF MIDDLEBELT

**FOR EVERYONE**  
 • EXCELLENT FOR PREGNANT WOMEN AND NURSING MOTHERS  
 • 100% SILICONE PROSTHESIS FOR MASTECTOMY PATIENTS

**NO STRAP STRAIN FOR FULL BUST**  
**NO PADDING FOR SMALL BUST**

**TILLBURY BOOK SHOP**  
 announces its **GRAND OPENING**  
**Books and Magazines for the Entire Family!**  
**SPECIAL 20% OFF ALL GREETING CARDS**  
 Open 7 days 10-6 Wed., Thurs., Fri. 'til 9  
**7353 LILLEY RD. (between Ford & Joy)**  
 Kings Row Shopping Center **459-6069 459-6090**

**Guys & Gals:**  
**MAKE YOUR EASTER APPOINTMENTS NOW!**  
*And you'll look great in the Easter Parade!*

**SPECIAL PERMS** ..... Reg. \$35... **\$17.50**

See **RON SHANE** for Precision Haircutting and CONSULTATION  
 FEATURING the LATEST TORONTO and OLYMPIC CUTS

**hair stylist**  
 Sheldon at Ann Arbor Rd. **455-3100** Plymouth

**AUTO SHOW CARPET SALE!**

Ever wondered what happens to the carpet used in Auto Shows and Conventions around the country? It is sold on an "as is basis" following each event. This carpet is now available in a wide selection of colors and styles at \$1.00 to \$2.50 per sq. yard.  
 Also new roll balances are available at special savings.

**DONALD E. McNABB CO.**  
 22150 W. 8 Mile Rd. (West of Lahser)  
 Hours: Mon.-Thurs. 9 A.M. to 4 P.M.  
 Friday 9 A.M. to 9 P.M.  
 Saturday 8 A.M. to Noon  
 Phone **357-2626**

**SCHOOLS**  
 Mod. Adls A/C 557-0776  
 2 BEDRMS. - CPT. D. PLYMOUTH - ELEV. OL. ALL UTILS. BUT AS 533-5113. 557-0770  
 Townhouses - Rental in Romulus area 2 1/2 br. mo. 3 bedrms. earn \$5,500-\$8,500 you for info. 941-1540  
**HERITAGE APPTS**  
 vial at Sheldon Rd. being taken for deluxe heat. Call: 452-2143 for heat.  
 311 - 2 bedrm. apt. Clean. \$125 UN-14308  
 11A W 1700 - Newly 2 bedrms. Util. reas.  
 MELPHIA - 3205 - 1 nd 575 mo. 895-6999  
 1 97 - Reas. rent. all M. Tyler. 832-1529  
 710 - Large apt. Ele 6  
 145 - Exclusive adult ns. Clean, quiet, now 111 883-2994  
 2 bedrm. townhouse. built. \$146 mo. plus 537-4972  
 V - 1-2 BDRM. APTS NTRFES APTS 285-8860  
 2 1994 - 4rm. apt 1 sec. dep.  
 OK Area - Accepting for a limited number of apt. homes. Offer range extras. AC, crtn. etc. Call: 1-921-9456  
 1111 W. 1700 - 1/2 sec. dep. 1110-9456  
 1537 - 3 rooms, 145

**FOUND**  
 During the past eight decades Detroit-area families have found at McCabe's the guidance and assistance they need.

**DEXTER** - 9330-9440 - Exclusive resident, middle-aged, older adults only. 3 large rooms, clean, quiet, newly decor. 485-5100 896-5735  
**DEXTER** - Select clientele, no other. need apply. 2 1/2 newly dec. 3.4 rms. married couple. no children. call 481-3275  
**DELAWARE** - 852 or Third Beach for ants. 576. call 366-6485  
**CLAWBARTON** - 57 3 rms. front

**NURSING HOME CARE IS AVAILABLE**

at Health Saving Services member convalescent homes in Livonia, Plymouth and Dearborn Heights for seven hours during the day; overnight; for a few days; a weekend; a week, or on a continuing basis. Social directors help make new friends and fill the day with pleasant activities geared to each individual's energy levels. Registered nurses provide constant attention, medicines are dispensed and physical therapy and special diets are provided. All homes are accredited by the Joint Commission on Accreditation of Hospitals. All are participants in the Blue Cross Extended Care Plan.

**DORVIN CONVALESCENT & NURSING CENTER**  
 29270 Morlock, Livonia GR 6-0550  
**HENDRY CONVALESCENT HOME**  
 105 Haggerty Road, Plymouth 455-0510  
**UNIVERSITY CONVALESCENT & NURSING CENTER**  
 28550 Five Mile Road, Livonia GA 7-8270  
**DEARBORN HEIGHTS CONVALESCENT CENTER**  
 26001 Ford Road, Dearborn Heights 274-4600

**OTHER PARTICIPATING FACILITIES**  
**St. Clare Convalescent Center**  
 15063 Gratiot, Detroit 372-4065  
**Allen Park Convalescent Home**  
 9150 Allen Road, Allen Park DU 6-2150  
**Marian Manor Medical Center**  
 18591 Quarry Road, Riverview 282-2104  
**Island View Apartments for Senior Citizens.**  
 283-8000

**HEALTH SAVING SERVICES**  
**559-3190**  
 We have earned your TRUST  
 16000 W. NINE MILE RD. / SUITE 404  
 SOUTHFIELD, MICHIGAN 48075

**THE ORIGINAL GREEK FESTIVAL**

**Saturday and Sunday April 10 & 11th**  
 (Athene Cafe in the Sears Court)  
**AUTHENTIC GREEK MUSIC**  
 (Music by the Mediterraneans)  
**Saturday 5 to 9 p.m.**  
**Sunday 1 to 6 p.m.**

**BELLY DANCERS** Saturday 7:00 p.m. Sunday 1:30 & 5:00 p.m.  
**ATHENIAN DANCERS** Saturday 8:30 p.m. Sunday 2:00 p.m.

**HELLENIC SOCIETY FOR THE PERFORMING ARTS**  
**SHISHKEBOB • PASTRIES • SOUVENIRS**

**MICHIGAN TREASURE HUNTER CLUB**  
**APRIL 9-11**  
 This statewide organization will be at Livonia Mall, this weekend, displaying some of their artifacts and other recovered items—from old coins and jewelry to antique bottles and lumberman's tools.  
 Additional displays of the group's activities, books and magazines, metal detector demonstrations, and displays of early Indian trails and villages in Michigan.  
 Stop by Livonia Mall, this weekend, and enjoy this interesting exhibit.

**Livonia Mall**  
 7-Mile at Middlebelt  
 Open Daily 'til 9:00 p.m. -- Sunday, Noon-5:00 p.m.

**GO GREEK!**  
 γιά σου  
 άγάπη

**McCABE funeral home**  
 Since 1893

18570 GRAND RIVER DETROIT, MICHIGAN  
 PHONE: VE-63752  
 William J. Johns, Manager

FARMINGTON LOCATION:  
 31950 TWELVE MILE ROAD PHONE: 477-0220  
 Edward P. Dewar, Manager

L. DAVID MC CABE, Director

# Easter's date depends on the moon

Easter — that moveable religious holiday whose date varies according to the vicissitudes of the moon—this year will fall on April 18, notes University of Michigan astronomer Hazel M. Losh.

"Easter is designated as the Sunday following the first full moon that comes after the vernal equinox, which this year was March 20," Prof. Losh explains.

She points out that in 325 A.D., church fathers gathered in Nicaea and decreed this for establishing the date of Easter. She adds that one reason for the method might be to afford bright moonlight for safe pilgrimages attendant upon Easter's celebration.

"Because of the dependence on the phases of the moon, however, the date

fluctuates widely," she continues. "In 1943, for example, Easter came on the latest date possible, April 25; that won't happen again until 2038. But March 24 is the most unusual date, its occurrence in 1940 being only the second since the Gregorian calendar reform of 1582 — and there won't be another March 24 Easter until 2391."

THE U-M astronomer says one of the most ancient and famous starfigures, Hercules, can be spotted in April. Resembling a giant letter "H", it can be found in the northeast between Corona Borealis and the bright star, Vega.

"To help in identifying Hercules, look for four stars that form a keystone," she says. "This keystone contains the great

globular star cluster, a fine telescopic object." Visible to the naked eye as a dim, misty patch of diffused light, the cluster is about 35,000 light-years from our planet and is believed to contain as many as 500,000 stars as bright as our sun.

To the south are the constellation Hydra the Water Snake and Corvus the Crow.

"Hydra, the longest constellation in the sky, sprawls some 90 degrees across the south below Virgo and Leo," Prof. Losh says. "It is closely connected to Hercules in that, according to legend, he is trying to slay this terrible creature." The brightest star in Hydra is Alphard, the "Solitary One." Orange in color and alone in its portion of the heavens, Alphard can be easily located in the heart of the reptile, she says.

CLIMBING IN the southeast is the "striking little lopsided figure, Corvus," she notes. "Composed of five stars, three of which are very bright, Corvus is supposedly pecking away at Hydra."

April is also the time of year to see the zodiacal light, she comments.

"This faint triangle of light may be seen, if you're lucky, in the west after sunset on a clear, moonless night," she says. "It is called zodiacal light because it follows the path of the ecliptic and passes through zodiacal constellations." Broad at the base, the light tapers into darkness toward the zenith. It is believed to be sunlight reflected by interplanetary dust concentrated most heavily in the plane of the ecliptic.

Of all the planets, Prof. Losh says, Mars and Saturn are the easiest to observe in April. Both are found slightly west of the meridian at sunset and will shine in the western sky until around midnight. East of Mars, Saturn is somewhat brighter than the red planet.

**Rite CARPET**  
Featuring America's Finest Carpet Mills — Largest Selection in the Area. Choose from Lees, Wunda Weve, Bigelow or Cabin Crafts  
7 Mile at Middlebelt 8497 W. Grand River  
Across from Livonia Mall Outside Brighton Mall  
476-8360 1-227-1314

**LOW COST AUTO and MOTORCYCLE INSURANCE**  
For all Drivers regardless of Driving Record  
• AUTO • CUSTOM VANS  
• TRUCKS: Local & Long Haul  
ALL RISKS & AGES  
No One Refused  
Financial responsibility available

**SAV-ON INSURANCE AGENCY, INC.**  
333 Inkster  
Cherryhill Plaza Annex  
563-8500

Extra Strength Diuretic Helps You **ELIMINATE EXCESS WATER**  
Lose pounds of excess body water weight, bloat, puffiness and relieve pressure-caused cramps, aches, tension due to pre-menstrual water build-up period. Aqua-Ban, the extra strength "water pill" works fast, gently to help your body eliminate excess water. You'll look better, feel better, be brighter, more active and alert! Stay at your slimmest! Trim-mest! Get Aqua-Ban Diuretic Tablets today.  
**aqua-ban**  
EXTRA STRENGTH WATER PILLS  
MEIJER thrifty acres Pharmacy Dept.

**Save \$65 on RCA's Colorama TV Picture tube replacement**  
**SALE \$134.95\*** Reg. \$200  
• No charge for installation. Repairs to chassis are extra.  
• RCA Colorama picture tubes fit most any make TV -19" -21" -25" at \$65 savings now.  
• If tube fails within 2 yrs. we'll replace it for labor cost only.  
INCLUDES PICK-UP, DELIVERY AND FREE TV CHECK.  
**STA-RITE TV**  
28915 Joy Rd. WESTLAND 525-5450

**Afraid of your mail box?**  
No friendly letters or post cards. Just bills and past-due notices. Rent. Department store bills. Credit card invoices. Car payments. Every week a few more come in. Some arrive in between paychecks and you put them aside until you have the cash. And if you forget to pay them, they send you a reminder. And on and on it goes.  
Well, Household Finance has a solution to the endless flow of bills. First, gather up every bill you have and figure what you owe. Then see HFC about a Billpayer Loan, of UP TO \$1,500.  
The Billpayer Loan from HFC. It makes your mail box seem a lot friendlier.  
**HFC**  
**HOUSEHOLD FINANCE CORPORATION & SUBSIDIARY COMPANIES**  
AN EQUAL OPPORTUNITY LENDER  
**LIVONIA**  
Livonia Mall Shopping Center  
29564 Seven Mile Road—PHONE: 476-4960  
**FARMINGTON**  
Farmington Plaza  
31624 Grand River Avenue—PHONE: 476-4200  
**GARDEN CITY**  
5637 Middlebelt Road—at Ford Road  
PHONE: 422-6100  
**WESTLAND**  
35253 Warren Road—Across From Westland Center  
PHONE: 728-7700

## SC approves \$10 million bond

Schoolcraft College building and site improvements can take place over the next five years following the board's 5-1 authorization of a \$10 million bond issue.

But providing funds to operate an expanded community college campus will be up to voters who must decide June 14 whether to raise the property tax limitation by 0.53 mills. The decision to place the tax question on the ballot was unanimous.

Trustee Ronald Cowden opposed the bond issue. By letter, trustee Arch Vallier, in semi-retirement in Florida, indicated he opposed paying for the bonds through an unvoted millage. Vice-chairwoman Rosina Raymond was absent.

The board was advised by attorney Robert Hammell and financial consultant Richard Barch that "the time is right for bond sales."

**GARAGE DOOR OPERATORS FOR ANY DOOR**  
GENIE "450" \$175 Installed  
1 Year Warranty Any Suburb  
**ALLIANCE AUTOMATIC DOOR CO.**  
531-0890 SOUTHFIELD

Said Hammell: "The present market and economic conditions are very favor-

## Tax tables are often misused

Many taxpayers are making errors in their 1975 income tax returns by failing to follow a tax table which continues to a subsequent page, according to the Internal Revenue Service (IRS).

R.L. Plate, IRS district director for Michigan, said the problem involves taxpayers who use the tax tables provided for persons with incomes under \$15,000 who do not itemize deductions. These people are overlooking the tax table that may continue to another page.

For example, in the tax tables included in the 1975 Form 1040-A instructions, most of tax table four appears on page 12, but the last part of table four appears on page 13 along with all of tax table five. Taxpayers using table four with an income between \$14,500 and \$15,000 would have to consult the top of page 13 to determine their tax.

"In skipping to the next page," said Plate, "some taxpayers are overlooking the continuation of the same tax table and are figuring their tax liability from the next tax table, resulting in an incorrect tax."

When an error is discovered, the IRS must contact the individual which, in turn, causes processing delays and unnecessary inconvenience to the taxpayer.

## Canoe class at Belle Isle

The Red Cross and the Detroit Department of Parks and Recreation are sponsoring instructional work in canoeing from 10 a.m. to 4 p.m. each Saturday, April 10-24, at the Belle Isle Canoe Shelter.

In addition to formal instruction, safety techniques will be demonstrated. Anyone who is at least 14 and can swim is eligible for the basic canoe course. To be eligible for the instructor canoe course, persons must be at least 17 years old and hold a certificate in basic canoeing.

Participants will need bathing suits and an extra set of clothing. For additional information, contact Red Cross Safety Programs at 833-4440.

## Republicans to hear 5 senate candidates

The Farmington Republican Club will host members of the Republican Clubs of Southfield, Livonia, Redford, Northville, Westland and Plymouth at a special meeting at 8 p.m. Wednesday in Botsford Inn, Grand River at Eight Mile.

The purpose of the meeting is to hear and evaluate Republican candidates for the U.S. Senate seat being vacated by Sen. Philip Hart. Scheduled to attend are: Thomas Brennan, Marvin Esch, Deane Baker, Louis Ingram and Robert Huber.

Students and senior citizens especially are invited. Any senior citizen needing transportation, phone Barbara Bowman at 349-7189.

**SCHMALZREIDT SONS Funeral Home**  
10625 GRAND RIVER  
BETWEEN GREENFIELD AND SOUTHFIELD  
DARLYNE C. SCHMALZREIDT LUCE, MGR.  
Dignity and Good Taste Distinguish Every Phase of Our Service

able for bond sales. We expect to sell the bonds by July 1."

Cowden said it was his position that the bond issue should be up to voters. "I'm not questioning the legality of selling bonds," he stated.

Vallier's letter said the board action "goes against all basic principles of democratic government and flaunts the will of the electorate."

Board President Paul Kadish replied that Vallier's letter indicated he questioned "the ethics and legality of the board."

"Not only do we have the legal authority, but we also have the responsibility to take action," Kadish stated. "The board is living up to the responsibilities the community entrusted us with by taking necessary action."

**catering** for every budget  
• Weddings  
• Showers  
• Graduations  
476-3424  
Your location or ours!  
*Paul A. Manig*  
CATERING CO. INC.  
CHALET OF FARMINGTON HILLS  
30689 Grand River

Midwest's Largest Selection of the Most Respected Names in Unfinished Furniture  
**The YANKEE CARPENTER**  
2215 S. Telegraph  
Bloomfield Miracle Mile Shopping Center  
338-0441  
Mon.-Sat. 9:30 'til 9 Sun. 12-5

**THERE'S MONEY HIDDEN IN YOUR HOUSE**  
IF YOU'VE GOT EQUITY IN YOUR HOUSE, WE CAN LOAN YOU MONEY FOR ANYTHING YOU NEED OR WANT.  
SEE US ABOUT A SECOND MORTGAGE LOAN  
**M F I**  
**METRO FINANCIAL INC.**  
SOUTHFIELD 557-3660

New portable **RINSE VAC** Gets carpets professionally clean.  
RENTS FOR ONLY \$12.00 a day  
**TOWN 'N' COUNTRY Hardware & Fireplace**  
27740 FORD ROAD • GA 2-2750  
3 MILES W. OF HUNTER ROAD • OPEN DAILY 9-5

## Warehouse Clearance MEN'S 10-Speed BICYCLE by Lambert



- Chrome-Molly frame
  - Alloy fork, drop bars, pedals & seat post
  - Cotterless crank \$119.95
  - All sealed bearings
  - Wt: 25 lbs.
- partially assembled  
Add \$10 for assembly adjustment  
\$240 Value

**MEN'S & LADIES MASERATI & ARCTIC 10 SPEED BIKES**  
Values to \$159  
**\$99.95**  
add \$10 for assembly & adjustment  
partially assembled

6 H.P. Roto Tillers \$230

**RECREATIONAL LEISURE**  
30717 W. 10 MILE  
Farmington 477-0212  
Open Sun.

Why Pay More! Why Pay More! Why Pay More!  
**REPEAT OF A SELL-OUT SHAG CARPET**  
Floor Covering Department  
**MEIJER**  
thrifty acres  
Special Purchase  
100% continuous filament nylon carpet. Beauty and durability at Meijer "why pay more" low price. The savings are yours. WHILE SPECIAL PURCHASE LASTS!  
Our Reg. \$4.99 to \$5.49 sq. yd. **\$3.99** square yard NOW ONLY  
**PRINTED CARPETS by Armstrong**  
An all-purpose carpet at a low, low price. WHILE SPECIAL PURCHASE LASTS.  
Our Reg. \$3.99 sq. yd. **\$2.99** square yard  
Our Reg. \$6.64 gal. **\$5.27** gallon  
**WELDWOOD MULTI-PURPOSE FLOOR CEMENT**  
**WELDWOOD CARPET CEMENT**  
For direct glue-down installation of indoor/outdoor carpet. Use over concrete, wood, plywood, terrazzo, and all resilient flooring.  
Our Reg. \$6.41 **\$4.99** gallon  
PRICES GOOD MON., APRIL 5 THRU SAT., APRIL 10, 1976.  
**MEIJER THRIFTY ACRES — 45001 FORD RD. AT CANTON CENTER RD.**  
SHOP MON. THRU SAT. 8 a.m. to 10:30 p.m. SUN. 9 a.m. to 7 p.m.

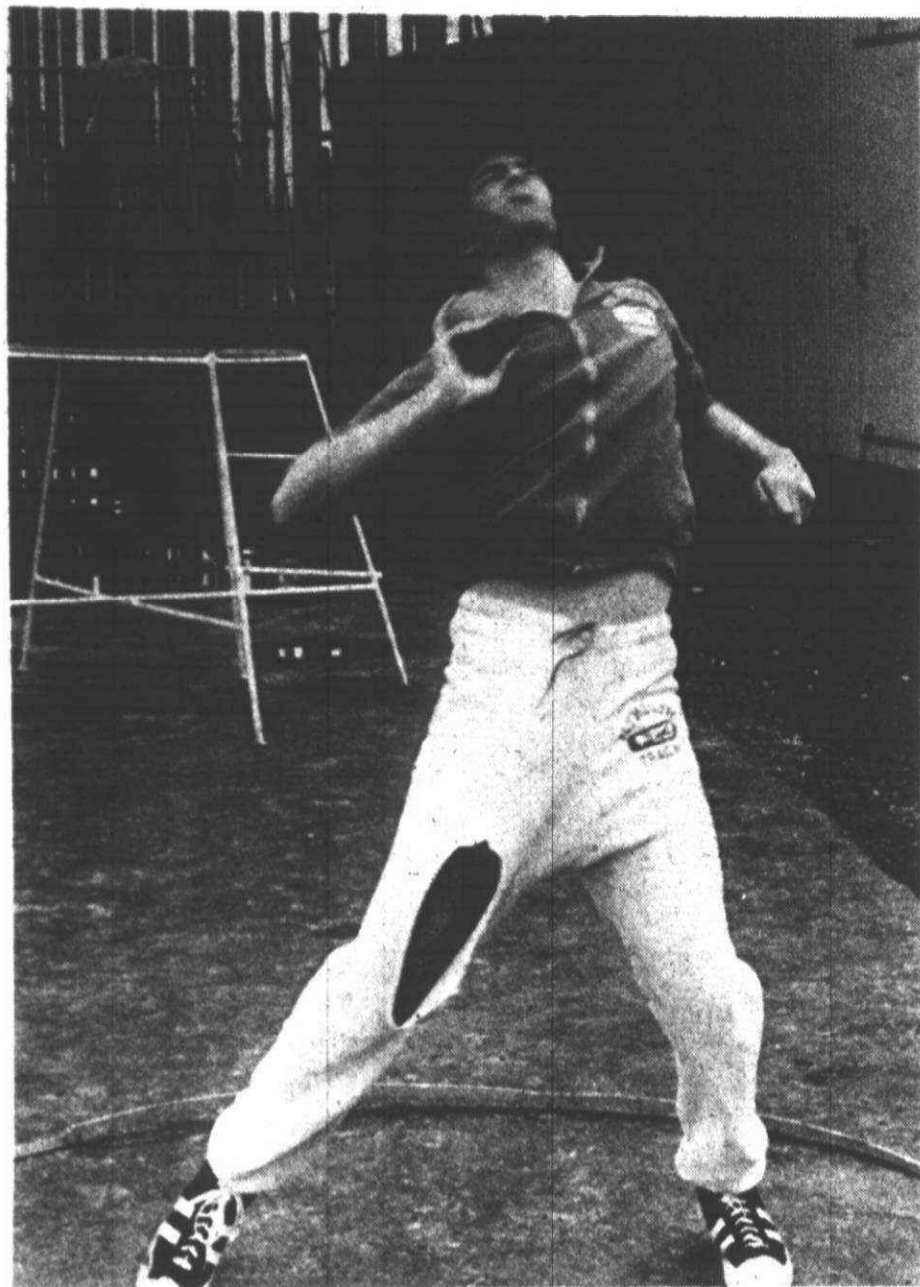

Putting it to the shot is Plymouth Salem sophomore Bob Dasher.

# Salem thinclads well balanced

By GREG AUSTIN

After losing five seniors, three of whom scored 75 per cent of the team's total points, is Plymouth Track Coach Gary Balconi complaining?

On the contrary, Balconi expects a more well-rounded squad for the 1976 season.

"Our one-two-three combinations should be much better this year," Balconi said.

The most notable loss will be that of Brian DeMerritt, who finished third in the state in the quarter-mile last season. DeMerritt is now attending Western Michigan University.

Balconi has high hopes for his field event performers, especially the high jumpers.

Bob Spisich is Balconi's number one man in the high jump, as he has jumped 6-1 in the past. Sophomores Chris Ritchie and Mike Christie have both recorded leaps of 5-10 ins.

Balconi is dependent on underclassmen in the pole vault, but has two sophomores who both cleared 11-6 as freshmen.

SALEM'S 880 RELAY team looks particularly tough with juniors Tom Kin-

ledge and Jerry Basierbe and sophomores Greg Davis and Chris Ritchie.

Davis and Ritchie are also 53-second quarter-milers, and will team with Basierbe and Tom Covington to form Salem's mile relay team.

Long distance events also look good for the Salem squad. Back from last year's team are senior Curt Judd, junior Walt White, and sophomore Scott Klean, who also ran well for the Salem Cross Country squad.

Hurdles remain one of Salem's weak spots. Balconi is relying on junior Pat O'Meara and sophomore Mike Stone in the high hurdles. Both have limited experience in the hurdles.

Dan Goepf looks to be Salem's top low hurdler, provided he stays healthy.

"Dan (Goepf) was hampered with injuries last year," Balconi noted. "He's a good low hurdler if we keep him healthy."

"Very fortunately my assistant coach, Dave Martin is a one-time All-American hurdler from Michigan State University. He should help out a lot."

Salem finished sixth last season in the

Suburban Eight conference. Balconi sees league champion Dearborn High School as "awesome."

"Trenton will also be stronger with a

new coach and a good bunch of sprinters," Balconi said.

Salem will open its 1976 track season at Trenton on Thursday, April 8.



Pole vaulter Mark Choma hits his mark.

## Observer & Eccentric SPORTS

6A (P.C.)

Monday, April 5, 1976

## Canton netter optimistic

By ROBIN WAGNER

The tennis outlook for Plymouth Canton High School this spring is unpredictable, with success dependent on a mixture of six excellent returning lettermen and a handful of inexperienced players.

"How our team does will depend on our success in the close matches, which we were lucky with last year. But whatever happens we'll be excited to watch," commented Canton tennis coach Jim Hayes.

The Canton netters, 8-5 last season, with a third place league finish and a fifth in the regionals, are once again led by a tennis showcase named Steve Prueter. Prueter, soon to be playing number one

singles for Canton for the third consecutive year, was 9-4 last year, selected to the Western-Six league team and a participant in the state tournament.

Junior Curt Hopfner, also an all-league member last year, should provide the perfect complement to Prueter in singles for Canton.

The remaining returning lettermen for Canton are senior John Herron, junior Steve Pasley and sophomore Chris Davio.

Best bets to move up from the junior varsity level are Dave Schmaltz, Matt Morris,

Doug Hetu, Don Falkerson, Matt Campbell and John Moran.

Canton opens its schedule at home on April 8 and 13 dueling Riverside and Livonia Stevenson.

The first home conference meet is against Northville on the 30th.

Coach Hayes sees no clear-cut favorite in the Western-Six race, but by successfully combining the promising veterans with the untested newcomers and adding a touch of good luck, Plymouth Canton could rise to the top.

## Maskin honored

George Maskin, who served 10 years as sports editor of the former Observer Newspapers, recently was presented an award by the Michigan High School Coaches Association for meritorious service in reporting the high school athletic scene.

Maskin, 59, covered prep sports for more than 25 years on the old Detroit Times and later worked on the Detroit Free Press sports staff. He played a major role in increasing the coverage of suburban and outstate high school athletics by the Detroit dailies.

When Maskin started on the Observer, he covered four schools—two in Redford Township and one each in Livonia and Plymouth. During his span with the paper, he built Observer coverage as the paper expanded, and at one stage, his beat included all the teams of 22 high schools.

For several years he also was public relations director of the Detroit Pistons basketball club and now is in charge of public relations for the thoroughbred meeting at Hazel Park race track.

Maskin and his wife, Elaine, who is a teacher at Troy High School, reside in West Bloomfield Township.



GEORGE MASKIN

**ARBOR DRUG CENTERS, INC.**

**"Lowest Prices ON ALL YOUR Prescriptions!"**

**7 STORES to SERVE YOU**

For Nearest Store Location call 336-4700

**REDWOOD FENCE CONSTRUCTION REDWOOD**

	6'	8'	10'	12'	14'	16'	18'	20'
1x4	.81	1.09	1.36	1.63	1.90	2.17	2.44	2.72
1x8	1.22	1.63	2.04	2.44	2.85	3.26	3.67	4.07
2x4	1.50	2.00	2.49	2.99	3.49	3.99	4.49	4.99
2x6	2.25	2.99	3.74	4.49	5.24	5.99	6.73	7.48
4x4	3.79	5.05	6.31	7.57	8.83	10.09	11.35	12.61

• GENUINE REDWOOD • BASKET WEAVE

• PRIVACY • 6'x8' SECTIONS **25<sup>95</sup> EA.**

**REDFORD CASHWAY LUMBER** DIVISION OF ERB LUMBER

LIVONIA 11970 FARMINGTON RD. 261-5110

DAILY 8-5:30 P.M. THURS-FRI 8:30

The fabulous **HARLEM GLOBETROTTERS** in person!

**Sunday, April 11**

Two Games—2:00 PM and 7:00 PM

**OLYMPIA STADIUM**

For Ticket and Group Sales Information—Call 895-7000

**PLENTY OF LIGHTED ATTENDED PARKING**

4 Easy Ways To Buy Your Tickets

- By Mail—send check, money order or Master Charge number to Olympia, 5920 Grand River, Detroit 48208. Enclose stamped self addressed envelope for return.
- By Phone—with Master Charge, call 895-7000.
- In Person—with Master Charge or cash at all Metro Grinnell stores or Olympia Travel (Maple at Lahser) in Birmingham. No day of show sales at these locations.
- At Olympia—now thru showtime with Master Charge or cash.

**50th ANNIVERSARY SEASON!!!**

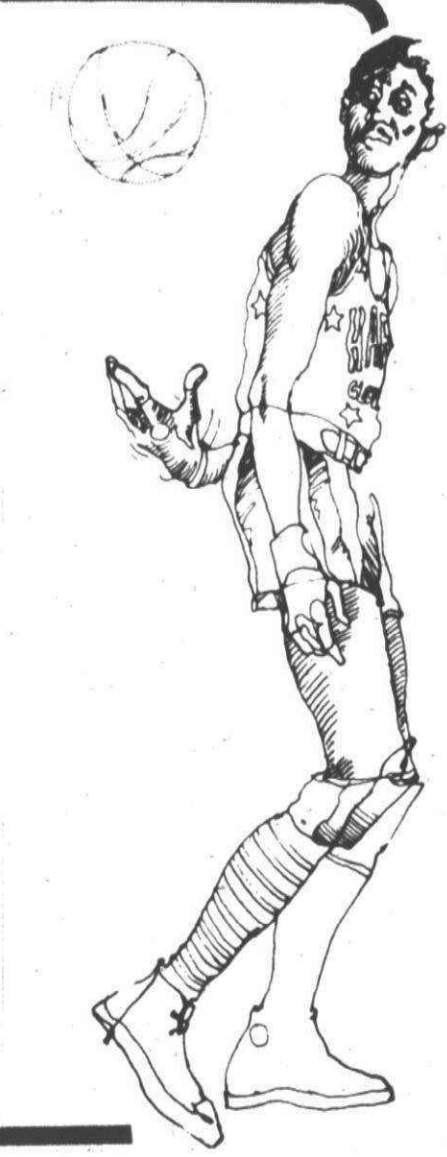

**HEAD FOR CYCLE COUNTRY**

Pierre's Kawasaki

1976 KAWASAKI KX 125 **\$649** + Tax, Freight, Set-Up

1975 KAWASAKI S-3 400 **\$949** + Tax, Freight, Set-Up

RACING FINISH WAX REG. 3.95 **2<sup>49</sup>**

ALL MAKES OF STREET AND OFF ROAD TIRES at **15% OFF**

COMPLETE LINE OF DRESS AND RIDING JACKETS **20% OFF**

SPARK PLUGS REG. 1.25 NOW! **88¢**

CHIPPewa GENUINE LEATHER Enduro Boots REG. 39.95 **\$19<sup>95</sup>** Save! \$20

KAWASAKI Z-1 900 OIL FILTER REG. 4.95 **\$1<sup>25</sup>** Save! \$3.70

CASTROL GTX REG. 1.25 NOW! **96¢**

Z-1 SAFETY BARS REG. 24.95 **14<sup>95</sup>**

COLORED PLASTIC FENDERS REG. 7.95 NOW! **3<sup>95</sup>**

IMPACT SCREW DRIVERS 1/4" & 3/8" Drive REG. 14.95 NOW! **6<sup>95</sup>**

ALL LUGGAGE RACKS & CUSTOM Sissy BARS **15% OFF** WHILE THEY LAST!

KAWASAKI K-2 OIL REG. 1.25 NOW! **96¢**

FACE SHIELDS Fit Most Helmets REG. 1.98 **1<sup>19</sup>**

**PIERRE'S KAWASAKI**  
30650 Plymouth Road  
LIVONIA  
261-2930

# Bentley to depend on solid hurling, defense

Pitching and defense are the two strong suits of the 1976 Livonia Bentley baseball team, as coach Marty Klozik says his club has a chance for the title in the rugged Suburban Eight League.

"The key is how our seniors and lettermen come through," the coach said. "We don't have too many people returning, but they're the heart of the ball club."

Klozik said that the Bulldogs' fortunes will revolve around the play of Don Nalepka, a senior, who was undefeated last year in spot pitching action. "Nalepka has to do the job," the coach stated. "If he goes right, he has to make things happen."

Another hurler, Brian Butcher, who dropped a couple of close 1-0 verdicts last spring, also returns and will be stationed at third base when not on the mound. "He bats left and hits the ball well," Klozik said.

Kevin Schultz, who played for the jayvees last season, will also get a chance to show his pitching skills. "He did pretty well last year," the coach stated. "He's a good competitor." Schultz, like Butcher, is said to swing a mean bat and could be moved to other positions when he is not pitching.

Mike Robbins, who played in the outfield last spring, has been moved to first base for the 1976 campaign. "He's a left-handed hitter, and I'm expecting him to do a job," Klozik said. Robbins, one of the fastest

men on the team, is a returning letter-winner.

Russ Hodges and Greg Gilchrist will be situated at catcher and shortstop, respectively, while Ted O'Connell, a junior who played jayvee ball last season, has been impressive at second base. "He's looked real good," Klozik offered.

The Bulldogs' coach added that he is also looking at a couple sophomores who may have a chance to see some action as the season progresses.

### SCHEDULE

Games at 4 p.m., unless noted

April 6, at Dearborn; 9, Allen Park; 13, at Dearborn Edsel Ford; 22, at Livonia Franklin, noon; 27, Redford Union; 30, at Belleville.

## Sports coming up

### Baseball

Monday (April 5) Garden City West at Westland John Glenn, 3:30 p.m.

Tuesday (April 6) Romulus at Garden City East, 4 p.m.

Tuesday (April 6) Redford Union at Trenton, 4 p.m.

Tuesday (April 6) Livonia Bentley at Dearborn, 4 p.m.

Tuesday (April 6) Belleville at Plymouth Salem, 4 p.m.

### Boys' Track

Monday (April 5) Livonia Bentley at Ypsilanti, 3 p.m.

Tuesday (April 6) Livonia Stevenson at Dearborn Edsel Ford, 4 p.m.

Tuesday (April 6) Clarenceville at Detroit Country Day, 4 p.m.

Tuesday (April 6) Plymouth Canton at Westland John Glenn, 3:30 p.m.

Wednesday (April 7) Redford Union at Dearborn, 4 p.m.

Wednesday (April 7) Redford Bishop Borgess at Livonia Churchill, 3:30 p.m.

### Girls' Track

Tuesday (April 6) Westland John Glenn at Garden City West, 3:30 p.m.

Tuesday (April 6) Garden City East at Livonia Churchill, 3:30 p.m.

Tuesday (April 6) Redford Union at Livonia Stevenson, 3:30 p.m.

Tuesday (April 6) Ladywood at Livonia Franklin, 3:30 p.m.

Tuesday (April 6) Redford Bishop Borgess at Dearborn Fordson.

### Tennis

Monday (April 5) Westland John Glenn at Garden City West, 3:30 p.m.

Tuesday (April 6) Taylor Truman at Garden City West, 3:30 p.m.

Tuesday (April 6) Romulus at Garden City East, 4 p.m.

Tuesday (April 6) Livonia Bentley at Dearborn, 4 p.m.

Tuesday (April 6) Redford Thurston at Livonia Stevenson, 3:30 p.m.

## West tennis team needs seasoning

Even though the Garden City West tennis team lost eight of 10 starters last year to graduation, coach George Hanosh does not believe his charges will do the el foldo this spring.

"We're not weak, but we're not strong ei-

ther," the coach said. "I don't look for an outstanding season, but I do expect we'll be better than 500."

The number one singles man, senior Rick Gwizdz, who compiled a 19-1 individual mark last season is back along with Dave Majestic, a senior doubles competitor. Those two are the only returnees from last year's undefeated, Tri-River League championship squad.

However, six juniors and three sophomores have impressed in pre-season practice to the extent that Hanosh is not worried about doing a complete pratfall in the months ahead.

The juniors include Greg Blanchard, Henry Leszczynski, Sean McGinty, Garth White, Mark Pratt and Bob Russell. The sophomore contenders are Mike Hare, Steve McGowan and Terry Oswalt.

Eight of the 10 varsity positions will be filled with the newcomers, who have showed promise the last several weeks in practice. In fact, interest was so high in the West tennis team that Hanosh selected his squad from a turnout of 30.

"It's nice when you get that many people to come out," the coach commented.

## Experience is key for diamondmen

The key to a successful Garden City West baseball season will be whether or not the eight senior returning letter-winners can establish themselves as solid performers early in the campaign.

"As of now, we're a little weak in pitching and a little weak on the left side of the infield," said coach Bob Dropp. "Our strong point would probably be experience because all our returning people played at least in part last year."

Leading the Tigers this spring are battery-mates and co-captains Tom Poole and Matt Shinsky. Poole, a lefthanded hurler who compiled a 4-2 mark last season, is expected to be the ace of the staff. Shinsky, a .230 hitter last spring, returns to his catching position.

Dave Noonan, who primarily played outfield and pilfered 11 bases in 12 attempts last season, will likely be West's number two pitcher. Dropp stated. A pair of sophomores, Carey Smith and Steve Campbell, will also get a chance to do some pitching, as will Bill Miner.

The Tigers' lineup appears to be pretty well set with Jeff Rutter at first base, Jeff Summers at second, Gene Gorczyca at shortstop and Ron Morelli at third. The outfield will consist of Greg Shinsky in left, Noonan in center, when he is not on the mound, and Roger Foley in right.

Other prospects for West include Dave Tatro and Pat Dougherty, who is a transfer student, in outfield slots, Wes Emerson, at first base, and catchers Bob Kinn and Jeff DeFrancescki.

"We have 17 on our roster now," Dropp said, "including a number of juniors who will have to be looked at."

Dropp, an 11-year veteran of Tri-River League baseball battles, figures that Taylor Kennedy, Southgate and Melvindale are the teams to beat in this year's race.

Order Your Pool Now... Swim on the First nice day.

the swimming pool people  
**Fanta-Sea Swim Centers**

23660 Grand River  
Detroit  
255-4510

27902 John R.  
Madison Heights  
541-5773

## OWENS LANDSCAPING

LOCATED IN LIVONIA

CALL 464-0832

RESIDENTIAL SPRING CLEAN-UP

- POWER RAKING (THATCHING)
- PRUNING & BED MAINTENANCE
- MANY OTHER SERVICES



## TELEVISION

SERVICE SPECIAL ONLY \$3

We will pick up your television set, bring it to our shop and have it checked by our TV experts. You will then be notified by telephone of the cost of repair. If you decide not to have it repaired we will return it to your home. All for only \$3.

USED T.V.s FOR SALE

STA-RITE TV

28915 JOY RD. WESTLAND  
PHONE: 255-5450

# Grand Opening

## Skateland West

America's Finest in Roller Skating Arenas

featuring

- The Newest in Sound Systems
- Blue, Seamless Plastic Floor
- 1,500 pairs of Precision Roller Skates

FOR YOUR SKATING ENJOYMENT SKATELAND WEST WILL BE OPEN

APRIL 9 — 7:00 P.M.

Your Spring Skating Schedule

DAY	TIME	SESSION	ADMISSION	SKATE RENTAL
MONDAY	4:00pm to 6:00pm	AFTER SCHOOL SPECIAL	\$1.25	50c
	7:00pm to 10:00pm		\$2.00	75c
TUESDAY	4:00pm to 6:00pm	AFTER SCHOOL SPECIAL	\$1.25	50c
	7:00pm to 10:00pm		\$2.00	75c
WEDNESDAY	4:00pm to 6:00pm	AFTER SCHOOL SPECIAL	\$1.25	50c
	7:00pm to 10:00pm		\$2.00	75c
THURSDAY	4:00pm to 6:00pm	AFTER SCHOOL SPECIAL	\$1.25	50c
	7:00pm to 10:00pm		\$2.00	75c
FRIDAY	4:00pm to 6:00pm	AFTER SCHOOL SPECIAL	\$1.25	50c
	7:00pm to 10:00pm		\$2.00	75c
	10:00pm to 1:00am		\$2.00	75c
SATURDAY	10:00am to 12:00pm	YOUNG PEOPLES SESSION	\$.75	50c
	1:00pm to 4:00pm		\$1.50	50c
	4:00pm to 6:00pm		\$1.50	50c
	7:00pm to 10:00pm		\$2.00	75c
	10:00pm to 1:00am		\$2.00	75c
SUNDAY	10:00am to 4:00pm		\$3.00	75c
	7:00pm to 10:00pm		\$2.00	75c
	10:00pm to 1:00am		\$2.00	75c

EXTRA SESSIONS ON FRIDAY, SATURDAY, AND SUNDAY EVENINGS — \$2.00  
EXTRA SESSIONS ON SATURDAY AND SUNDAY AFTERNOONS — \$1.50

37550 CHERRY HILL ROAD, WESTLAND  
326-2800

Warning: The Surgeon General Has Determined That Cigarette Smoking Is Dangerous to Your Health.



AS LOW AS YOU CAN GO AND STILL GET GOOD TASTE.

NEW! KENT GOLDEN LIGHTS.

SMOKING SATISFACTION WITH ONLY 8 MG TAR.



SPECIAL! WESTERN BARK

2 1/2 CU.FT. BAG \$2.00

Plymouth Nursery  
9900 ANN ARBOR ROAD  
(at 1 1/2 Miles W. of Southgate Rd.)  
PLYMOUTH • 453-5500  
HOURS: DAILY 9-6 SUN. 10-6

# In The Pocket

There will be no lack of keen competition for many area bowlers during the coming summer.

For years they claimed that it was beneficial to keep shooting at the pins during the hot weather—but there was little incentive.

That has now been remedied by the Bowling Proprietors Association which is sponsoring an all-star mixed tournament for 12 weeks, beginning May 26 and continuing through Aug. 11.

The league will consist of four-member teams—two men and two women—and it promises to be a battle right to the end.

The league will be welcomed to Marge Kropacek of Plymouth, who captains the Shirey team in the Bowlerettes loop.

Marge suffers from a bad back and needs the exercise she gets from bowling. During the winter, she bowls in five leagues and tries to compete in that many during the summer. Last summer, to make up the fourth league, she teamed with her husband on the lanes one night a week. Now, the new league, gives her the competition she needs.

DON WILLIAMSON went on a real scoring spree that earned him membership in the 700 Club at Merri-Bowl Lanes.

Taking his turn in the Consumers League, he found the range for games of 233, 254 and 258 for a 745—a new high for the league.

In the invitational doubles, top honors went to Polly Cole with a 649. She opened with a 214, duplicated it in the second and closed with 221. Her nearest rival was Myrna Hille with games of 198 and 210 in a 588 series.

COMPETITION REACHED a new high in the outsiders mixed league at Plymouth Bowl, with Jerry Talaga and his wife Pauline joining Louie and Sue Price for a 2,396 series on games of 857, 814 and 725.

Jerry, who carries a 143 average, put together games of 251, 199 and 175 for 625, which is 196 pins over average. Pauline contributed a 510. Meanwhile, Louie strung games of 265, 224 and 173 for 662. And Sue added a 371 to complete the high series for the team.

THIS WAS A BIG WEEK at Country Lanes, and it all started when Dave Brown of North Farmington High School, who carries a 150 average, came through with games of 235, 177 and 230 for a 642.

In the same league, Jerry Schemkel posted a 262 game and Bobbi Gooding, last year's Country Lanes Queen, had games of 206, 194 and 204 for a 602.

Other good scores at Country Lanes included a 627 by Ray Worthington in the Friday Men's circuit, and Wes La Palme who fired a 692 on games of 278, 279 and 135 in the Sunday Traveling League.

The booby prize for the week went to Mike Duckett who rolled a 279 series on games of 109, 92 and 78.

LOIS MEETIMAN was up to her old tricks in the Livonia Ladies Classic when she won the final game 229-28-257 and the series with 563-84-647.

In the other games, Mary Bierkamp won the opener with a 173-55-228 and Marie Finch took the second with 206-27-233.

ONE OF THE BEST series of the season at Livonia Lanes was posted by Don Eastman, a 177-average bowler in the junior house league. Finding the range, he opened with a 213, followed by a 244, and closed by a 247 for 704 to earn membership in the 700 Club.

Among the women, Nancy Renner, bowling with the working girls, went over her 135 average with a 221 game.

ANOTHER LADY who gained a place on the honor roll was Jan Bennett, a 147-average bowler at Plaza Lanes.

## Charger thinclads race by Patriots

Two area rivals got together last Thursday, as in years past, to officially inaugurate the spring track and field campaign, and on a cold, windy, damp afternoon, Livonia Churchill edged Livonia Franklin, 70-62.

The proceedings couldn't have been much closer, as each team finished first in eight events. As things turned out, the Patriots.

"We figured if we won all three relays we would win," said Franklin coach Robert Holmes, "and I'm sure Churchill felt they had to win one of the relays to win."

The Patriots captured both the 440-yard and mile relays, the final two events. But by then, the Chargers had insured the meet victory by placing first and second in the two-mile run.

The Franklin mile relay team also finished 25-yards ahead of the Churchill crew, but as Holmes stated, the baton exchange took one stride longer than the stipulated distance, and the Patriots were disqualified.

Churchill's greatest strength was in the distance events, as the Chargers swept the mile run and placed one-two in the two-mile run. Franklin thinclads, meanwhile, finished first and second in both the 100-yard and 220-yard dashes.

"It was miserable, but we got the meet in," Holmes stated. "The performances were very good though, considering how bad the weather was."

### RESULTS

- Discus—1) Adam (F) 2) Kieley (C) 3) DeWitt (C) 137 feet five inches.
- Long Jump—1) Boldt (F) 2) Janowski (C) 3) Chapel (C) 19 feet 7 1/2 inches.
- Pole Vault—1) Marzion (C) 2) Gorman (F) 3) Mapes (F) 11 feet six inches.
- Shot Put—1) Rae (F) 2) Kahdt (C) 3) Kaseta (F) 50 feet three inches.
- High Jump—1) Kline (C) 2) Chapel (C) 3) Middleditch (C) six feet.

All she did was link games of 233, 187 and 198 for a 618 series.

Meanwhile, William Brietmaier rolled an all spare 185 game in the senior citizens league.

A NEW STAR appeared on the horizon of women's bowling during the past week when Jan Marciniak teamed with Penny Behn to take over the doubles lead in the women's city tournament.

Jan, who had been touted as a young bowler to watch, turned in a fine performance in the city event when she and Penny posted a 1268 in actual pins and a handicap score of 1340 that many say will be good enough to lead the tournament all the way.

To prove that her big showing in the title event was no fluke, Jan came back in the Ladies Major League Wednesday with a 636 that topped the entire league.

MARIE COLLINS moved into the Queen's row at Merri-Bowl when she set two marks in the Wednesday Nite Classic.

She put together games of 242, 171 and 192 for a 605. Both her high single and her series count for the season, were tops in the league.

SCORING DROPPED off a bit in the Wonderland Classic as Tony Thivierge and Joe Charron waged a battle for top place and neither was able to break the 700 barrier.

Tony finally landed in top with a 682 on games of 224, 223 and 235, while Charron dropped to 189 in the final game after counts of 252 and 235. He settled for 676 and second place.

Charron had the satisfaction, however, of leading his team to the pace-making role with a 3144 on games of 1026, 1050 and 1068.

Tom Hay came up with a 246 for high game in the Mixed League at Farmington Lanes, but the rare atmosphere must have been too much. He faltered in his other games and had to be content with 626 series.

In the Friday Classic, Jeree Sirdynski set the pace with a 212 in 595.

ESTELLE MAURER will have good reason never to forget her big moment in the Queens Pin League at Westland Bowl.

Though she doesn't actually know how it happened, she toppled the "impossible" 7-10 split.

In the ladies classic, Marilyn Bourgoin had games of 202 and 222 in a 620 series, to beat out Jane Martin, who rolled counts of 202 and 192 in a 596 series.

THE GREATER DETROIT men's bowling association has attracted 810 teams in the regular division of the annual tournament that is to open at Thunderbowl in Allen Park on Saturday, April 10 at 5:30 p.m.

The senior division which is growing more popular each year, has an entry of 122 teams.

IMPROVING WITH each game, Dick Bond took over the pace making role in the Bel-Aire Classic with a 664 count. He started with a 213, followed with 215 and closed with 236.

Jim Timmerman was right behind with a 656 that included a middle game of 235, and Andy De Camillo faltered after starting with a 269 and ended up with 651 and third place. Ben Loch also started well with a 257, but settled for a 646 and fourth place.

THE SHARPSHOOTERS found the range at Garden Lanes where Zen Miziol paced the Vinco League with a 675 and Al Messerac showed the way in the Classic with 667.

In the Classic, Roger Thorpe trailed Messerac by 24 pins with a 643. His nearest rival was Don Ratky, who took third with 614.

## Figure skaters place in finals

880-yard Relay—1) Churchill (Franklin disqualified) 1:36.8.

880-yard Run—1) Ronan (F) 2) Palmer (C) 3) Wiepecha (C) 2:00.3.

High Hurdles—1) Hanna (C) 2) Lee (F) 3) Deroche (C) :15.5. (C) 4:42.0.

100-yard Dash—1) Yuhasz (F) 2) Smith (F) 3) Doyle (C) :10.4.

440-yard Run—1) DeFlorio (C) 2) Ronan (F) 3) Fournier (F) :53.0.

Low Hurdles—1) Hanna (C) 2) Lee (F) 3) Williams (C) :21.2.

Two-Mile Run—1) Martins (C) 2) Winfrey (C) 3) Hudock (F) 10:20.4.

220-yard Dash—1) Casey (F) 2) Smith (F) 3) Streicher (C) :22.9.

Mile Relay—1) Franklin 2) Churchill 3:37.4.

440-yard Relay—1) Franklin 2) Churchill :45.4.

## Figure skaters place in finals

Five members of the Plymouth Figure Skating Club placed in the finals of the recent Western Ontario Section Winter Invitational competition in Sarnia.

Susan Colaianni, 10, of Plymouth, competed in preliminary ladies and placed first in initials and fifth in the finals. Kathy Donnelly, 12, of Plymouth, in preliminary ladies placed first in initials and sixth in finals.

Jim Sellman of Plymouth and Miss Donnelly placed fourth place in pairs.

Brooke Fournier, 11, of Livonia, also a member of the Detroit Figure Skating Club, placed second in test ladies and fifth in initials. Linda Kauneyer, 14, of Garden City, competed in preliminary ladies and placed fourth in initials.

The skaters' pros are Sandy Magnuson and Carol Holcomb.

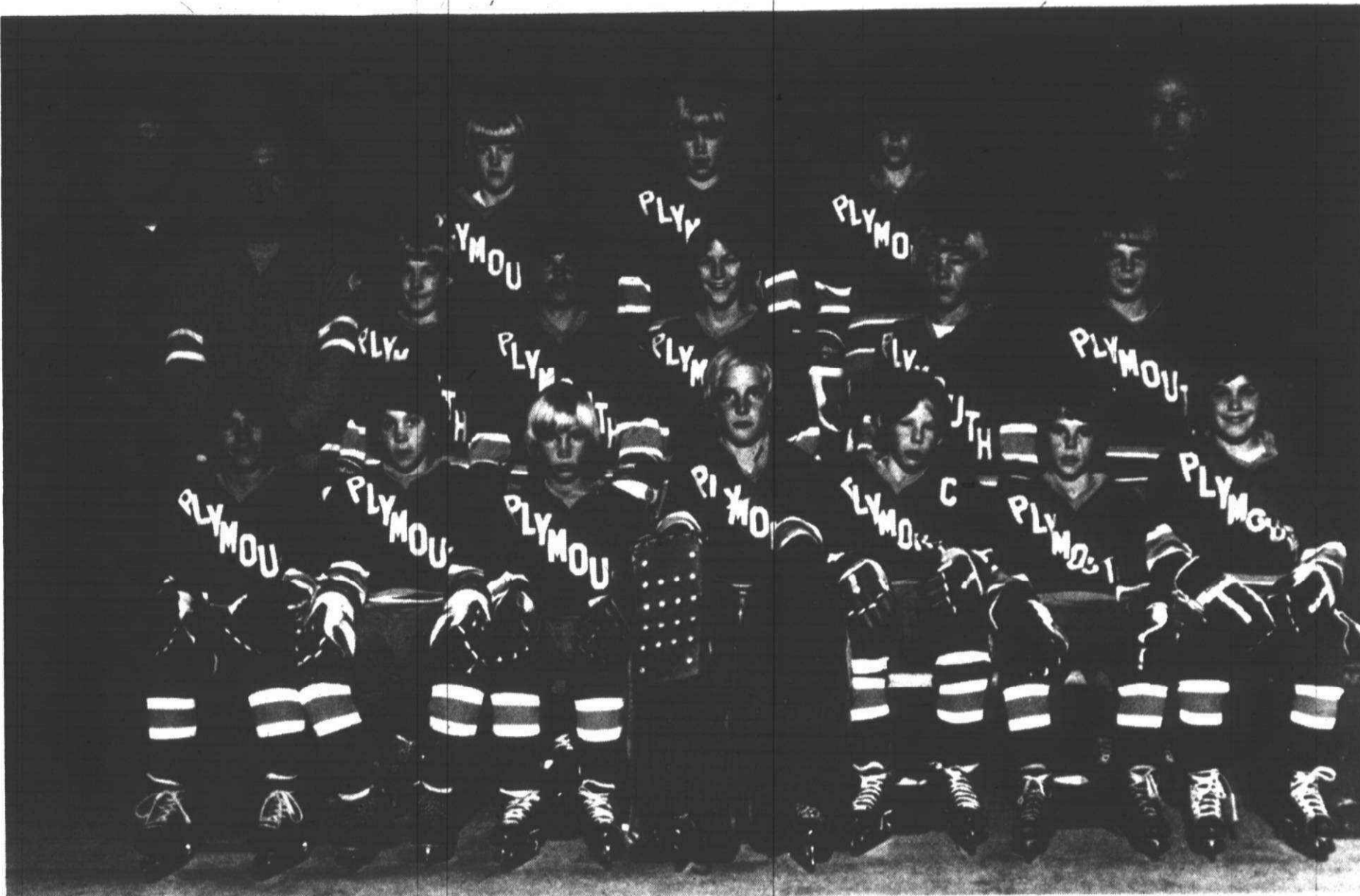

## Tough Squirts

The Plymouth Hockey Association Squirt Travel team, skating in the District 5A league, concluded an impressive campaign with a playoff victory over Garden City. The playoffs, a two-time, total-goals series, was won by Plymouth, 6-2. The young squad previously had been declared league champion after finishing

the season with a 23-5-4 mark. Overall, the squirts were 41-16-8. The team was captained by Paul Norton while Alan Carnes was the leading scorer. Goaltender Craig Mooney totaled 18 shutouts on the campaign.

*Sssh!*  
**Keep this under your hat...**



### FREE CLASSIFIED ADS

It's a celebration, and only classified users are invited! To honor International Want Ad Week, we are giving away a free classified ad to every 100th person calling our want ad department next week (April 12-16). All you have to do is dial one of the numbers below any time between 8:30 a.m. and 5:00 p.m. to place a non-commercial ad, and you may be a winner!

Even if you don't win, you can still take advantage of our low Twin Action rates. Now you can sell your unused household items by placing a 15 word ad in two issues for only \$6.00.

You're always a winner with Observer & Eccentric classified ads, but next week the prize is better than ever.



Have your Master Charge of BankAmericard handy whenever you call.

Observer & Eccentric Classified Ads

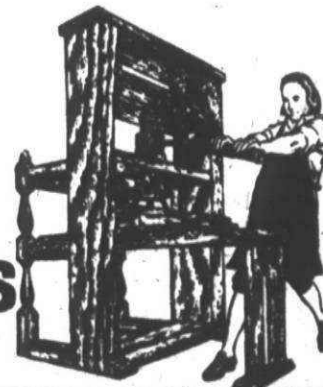

RING THESE NUMBERS:  
522-0900 (Wayne County)  
644-1070 (Oakland County)  
852-3222 (Rochester/Avon)

# Stempien will run for Congress seat

Marvin R. Stempien, former majority floor leader of the Michigan House of Representatives, has announced he will be a candidate for the Democratic nomination for Congress in the 2nd District, which includes Livonia and Plymouth.

Stempien served three terms in the Michigan House, the final one as majority floor leader. The Livonia attorney is a former Northville city attorney, legal counsel to Wayne County Community College, and advisor to the Speaker of the Michigan House. He currently is judicial assistant to the Court of Common Pleas.

ISSUES WHICH affect the quality of life for all people, he said, will be the focus of his 1976 candidacy.

"Since the Nixon-Ford administration took office, the massive increases in inflation and the spectre of substantial job layoffs have deprived working people of a decent standard of living, and have cut off opportunities for improvement for small businessmen. Our economy has made stockbrokers and money-lenders happy, but has been devastating to both breadwinners and employers.

"The fear of violent crime has placed se-

vere and unnecessary limitations on all of our lives. Americans have lost confidence in the ability of government to respond ef-

fectively to the problems that affect their lives. Only a firm commitment by all candidates in 1976 to improve the quality of life, by working to reduce economic and social restrictions, will restore the faith Americans have in the responsiveness of government."

STEMPIEN SAID he will discuss such issues as inflation and unemployment, energy conservation, education opportunities, consumer problems, the control of violent crime, the lack of honesty and openness in government.

Stempien led the Democratic ticket in his candidacy for Congress in the 2nd District in 1972. He was named Conservationist of the Year in 1970 by the Michigan United Conservation Club, and Outstanding Freshman Representative by the Lansing press corps in 1965. He has practiced law since 1961 and has been involved in public service for more than 15 years.



MARVIN STEMPIEN



## Riegle to speak

U.S. Rep. Donald W. Riegle, Jr. (D-Flint) will address the Rotary Club of Plymouth at noon Friday, April 9, in a luncheon meeting which will be open to the public. Riegle, elected nine years ago, is the youngest congressman ever assigned to the House Appropriations Committee and is a member of the International Relations Committee. He is author of the book "O Congress," has written several magazine and newspaper articles, and has served on the faculties of Michigan State University, Boston University, Harvard, and the University of Southern California.

## Dem workshop

The Northville-Plymouth Democratic Club is gearing up for the coming election with a campaign workshop to be held at 6 p.m. April 9 in the Plymouth Community Credit Union, 500 S. Harvey. Refreshments will be served and plenty of time allocated so residents can meet the candidates' representatives.

**GENERAL TIRE**

SOONER OR LATER, YOU'LL OWN GENERALS

**LIVONIA**

19601 MIDDLEBELT RD.  
Near Livonia Mall  
477-1100

**LEE WHOLESALE SUPPLY**

55965 Grand River  
New Hudson, Mi.

**GAF Certainteed**  
Roofing Products  
Built Up Roofing Supplies  
Aluminum Siding - Trim - Gutters  
Shutters Made to Order

CALL FOR PRICES  
(313) 437-6044 or 437-6054

**CHARTER TOWNSHIP OF CANTON INVITATION TO BID**

NOTICE IS HEREBY GIVEN that bids will be taken on the following items until 8:00 P.M. on Tuesday, April 13, 1976 at 128 Canton Center Road, on the following items:

1. One 1976 Window Van
2. One 1976 1/2 Ton Pickup
3. One Garden Tractor with Attached Mower
4. One Combination Sewer Jet with Catch Basin Cleaner mounted on new truck with 49,000 GVW.

Specifications on the above equipment are available at 4458 Geddes Road.

The Township reserves the right to refuse any or all bids deemed not to be in the best interest of the Township.

JOHN W. FLODIN, Clerk

Publish: April 5, 1976

**NOTICE TOWNSHIP OF PLYMOUTH**

Dog Licenses are due prior to June 1, 1975 and are available at the Plymouth Township Hall, Treasurer's office, 52350 Ann Arbor Road, Plymouth, Michigan, Monday through Friday, 8:30 A.M. to 5:00 P.M.

Licenses prior to May 31, 1976 \$3.00  
Licenses after May 31, 1976 \$5.00

Dogs must have a current rabies vaccination and owners must show proof of vaccination when obtaining dog licenses. Owners of all dogs not vaccinated and licensed before June 1 will be subject to violation tickets.

Please remember you are also in violation if your dog is permitted to run at large or its frequent whining, barking, yelping or howling shall cause serious annoyance to the neighborhood or to persons passing to and fro upon the public highway.

JOSEPH H. WEST  
Plymouth Township Treasurer

Publish: April 5, 19 and May 20, 1976

**CHARTER TOWNSHIP OF CANTON ZONING BOARD OF APPEALS**

NOTICE IS HEREBY GIVEN that a regular meeting of the Zoning Board of Appeals will be held on April 12, 1976 at 7:30 P.M. at 128 Canton Center Road to consider the following items:

1. To consider the request of Republic Management Company for permission to install an entry sign at Fellows Creek Villa located on Ford Road between Canton Center and Sheldon Roads.
2. To consider the request for a variance to construct a garage on Lot No. 4 of Cherry Hill Pines Subdivision, 41511 Wayside Drive.
3. To consider the request for a variance to construct a garage at 44600 Whitman.
4. To consider the request of Bank of the Commonwealth for an extension of the permit to locate a temporary structure at the northeast corner of Warren and Sheldon.
5. To consider a request to re-open the gasoline service station at 345 S. Canton Center Road.
6. To consider the request of Practical Home Builders for a variance in the tree planting and preservation ordinance in connection with the development of Brookside Village Subdivision No. 3.
7. To consider a request for a variance in the tree planting and preservation ordinance in connection with the construction of the motel and restaurant complex at the northeast corner of Fard and Lotz Roads.
8. To consider the request of Cyprus Gardens Restaurant for permission to erect a temporary sign.
9. To consider a request to split tax item No. 03U8 71-011-0018-000 located on the west side of Sheldon between Warren and Joy Roads.
10. To consider the request of American Fence Co. to locate their fence business at 41700 Michigan Avenue.
11. First Federal Savings application for a six-month extension of the temporary use permit for trailer office at Ford and Haggerty Roads. Expires April 28, 1976.
12. To consider any other business that may come before the board.

JOHN W. FLODIN, Clerk

Publish: April 5, 1976

**WAYNE COUNTY BOARD OF ROAD COMMISSIONERS**

To the Supervisor and Clerk of the Township of Plymouth, Wayne County, Michigan:

Sirs:

You are hereby notified that the Board of County Road Commissioners of the County of Wayne, Michigan, did, at a meeting of said Board held on March 18, 1976, decide and determine that the certain streets described in the minutes of said Board should be County roads under the jurisdiction of the Board of County Road Commissioners. The minutes of said meeting fully describing said streets are hereby made a part of this notice, and are as follows:

Minutes of the regular meeting of the Board of County Road Commissioners of the County of Wayne, Michigan, held at the Board's offices, 415 Clifford, Detroit, Michigan, at 9:00 A.M., Eastern Standard Time, Thursday, March 18, 1976.

Present: Chairman Burton, Vice-Chairman Berry and Commissioner Herron

\*\*\*\*\*

"Commissioner Herron moved the adoption of the following resolution:

BE IT RESOLVED by the Board of County Road Commissioners of the County of Wayne, Michigan that it hereby accepts the dedication to the use of the public of the following described roads and they are hereby taken over as county roads and made a part of the county road system of the County of Wayne:

All of Albert and Mayflower Drives; Baywood Road, Erik Pass and Mayflower Court as dedicated to the use of the public in MAYFLOWER VILLAGE SUBDIVISION, part of the S.W. 1/4 of Section 34, T. 1 S., R. 8 E., Plymouth Township, Wayne County, Michigan as recorded in Liber 96 of Plats on Pages 52 and 53, Wayne County Records, constituting a total of 1.071 miles of County Roads.

The motion was supported by Commissioner Berry and carried by the following vote:

Ayes: Commissioners Berry, Herron and Burton.  
Nays: None."

\*\*\*\*\*

THIS NOTICE IS GIVEN UNDER AND BY VIRTUE OF ACT NO. 283 OF THE PUBLIC ACTS OF 1909, AS AMENDED.

In testimony whereof, I have hereunto set my hand at Detroit, Michigan this 19th day of March, A.D. 1976.

FREDDIE G. BURTON, Chairman  
MICHAEL BERRY, Vice-Chairman  
JOSEPH N. HERRON, Commissioner  
Board of County Road Commissioners  
of the County of Wayne, Michigan  
H. J. GALECKI, Secretary  
and Clerk of the Board

Publish: March 29, 1976

**WOMEN'S GOLF LEAGUE**

April 5—Registrations are now open for Canton Township Women's Golf League, which will begin season at Fox Hills on May 28. League will play Fridays at 8 a.m. for 10 weeks and is open to all women living or working in Canton. Call recreation office, 397-2777. Registration fee is \$5.

**ART EXHIBIT**

An exhibition of Schoolcraft College student work in drawing, design, painting and print-making will be in the Schoolcraft College Northville Cooke Center, 405 W. Main, Northville, now through April 23. Monday through Thursday, from 9 a.m. to 9 p.m. A reception will be held April 6 from 7-10 p.m.

**CAMERA CLUB**

April 7—Western Wayne County Camera Club meets at 7:30 p.m. in Plymouth Cultural Center. Meeting on the first Wednesday of each month, the club is open to all interested in photography. Featured will be lectures, seminars, and workshops and use of a darkroom will be available.

**'K' SIGN UP**

April 7—A kindergarten registration will be held in the gym of Bird Elementary for all parents who have potential kindergartners to attend school next fall. If you have 'new neighbors with kindergartners for next year, call the school office giving the name and address.

**CARD PARTY**

April 8—A salad luncheon card party, put on by the Women's Guild of St. Kenneth Catholic parish, will begin at 12:30 p.m. in the church on Haggerty south of Five Mile. Donation is \$3.25. For tickets call 455-4675 or 349-7417.

**SCOUT CAR WASH**

April 10—Get a clean car for Palm Sun-

## Central plans a Band-Arama

The Central Band Boosters Club and members of the bands at Central Middle School are sponsoring a Band-Arama from 4 p.m. Friday, April 9, to 4 p.m. Saturday, April 10.

Band-Arama will feature 24 hours of continuous music performed by beginning, intermediate, advanced and stage bands, and the brass club.

Purpose is to raise funds for music scholarships, instruments, music, repairs, and supplies. Each band member is being encouraged to obtain sponsors to pledge any amount they wish. Pledges can be given to any band student, or mailed to Central Band Booster Club, 42118 Lakeland, Plymouth. Pledges also will be accepted during the 24-hour marathon of music.

"We hope that all those who sponsor, and the interested public, will join these eager young people and take a moment to stop, hear the music and observe how hard these students are working to better a program of which they are so proud," says Lois Hotchkin, secretary-treasurer.

**LIVONIA BUILDING MATERIALS FORMICA**

30"x96"  
36"x96"  
YOUR CHOICE  
**70¢** sq. ft.

OTHER SIZES AND COLORS AVAILABLE. PRICED PER TYPE AND FINISH. 2 DAY DELIVERY.

Mon.-Fri. 8-5 Sat. 8-12  
12770 Farmington Rd.  
S. of Schoolcraft Rd.  
937-0478 421-1170

day at car washes sponsored by Plymouth Girl Scout Cadet Troop 626 at the Marathon gasoline station at Penman and Harvey. Hours are 9 a.m. to 3 p.m. and cost is \$1 per car. The troop is earning money for a summer camping trip throughout Michigan. July 21-27.

**COMMUNITY SCHOOLS**

April 14—The spring classes for exercise, volleyball and swimming in Central Middle School, 650 Church, will begin April 14 from 7-10 p.m. The class will be held for eight weeks. To register send your name, address and phone number with a check for \$10 made payable to Plymouth Community Schools, Continuing Education Department, 8415 Canton Center Rd., Plymouth 48170.

**bi-CENTRAL-ennial**

April—During month of April reservations will be taken for table space for the Central Middle School "bi-CENTRAL-ennial Festival and Craft Show" on May 22. Tables now available at \$10 each. For rental, contact Barb Carpenter of the school's P.T.S.O. at 455-4799 or Darlene Sommerville at 543-8215.

**DOG LICENSES**

Dog licenses are due before June 1 and are available now in the treasurer's office, Plymouth Township Hall, Ann Arbor Road at Lilley, Monday through Friday from 8:30 a.m. to 5 p.m. Licenses are \$3 prior to May 31 and \$5 after. Bring proof of dog's current rabies vaccination.

**RENT SOFT WATER THE CAREFREE WAY!**

And when you do, you'll discover that your skin is softer, you'll save 1/2 on washing materials because you won't need to buy fabric softeners, your beverages taste better — even ice!

Our Heavy-Duty Multi Purpose Reynolds Fully Automatic Water Conditioners REALLY remove rust and iron hardness and rent for as little as \$11.00 a month.

Call us Today!

**REYNOLDS WATER CONDITIONING CO.**  
Michigan's oldest water conditioning company  
CALL TOLL FREE 1-800-552-7717  
Serving this area since 1931.

**Snapper's Great GIVE-A-WAYS!**

**FREE SNAPPERIZER**

\*\$26.95 VALUE . . . FREE with the purchase of any V-Service Mowers!

**THE OPTIONAL SNAPPERIZER.**  
ANOTHER FIRST FROM SNAPPER!  
This convenient attachment makes cleaning up leaves half the job because you empty half as often. The leaves are pulverized so the catcher can hold at least twice as much.

**FREE bag Attachment**

\*Reg. \$87.50 . . . Free with the purchase of any Riding Mower.

Optional 6-bushel grass catcher vacuums your lawn as you mow. Grass catcher is mounted behind the mower for total maneuverability. With proper attachments, Snapper can solve many yard care problems with ease!

**AVAILABLE AT THE FOLLOWING SNAPPER DEALERS**

NORTHVILLE	CANTON	PLYMOUTH	WAYNE
MARKS SMALL ENGINE 16959 Northville Rd. 349-3860	CANTON POWER CTR. 46600 Ford Rd. 453-0295	WHITE SALES & SERVICE 7777 Sheldon 453-5287	SAXTON GARDEN CENTER 587 W. Ann Arbor Trl. 453-6250
			WAYNE LAWN & GARDEN CENTER 2103 Wayne Rd. (N. of Michigan) 721-5220

OFFER EXPIRES APRIL 10



Prince Dauntless, portrayed by David Shephard, finally meets the perfect princess—Winifred—played by Kathi VanAernum.



In the musical "Once Upon A Mattress," opening April 9, are: (from left) Minstrel (Frank Mercieca), King Seximus (Todd Barker), Lady Larken (Holly Wagner), and the Jester (Greg Goldston). (Staff photos by Gary Caskey)

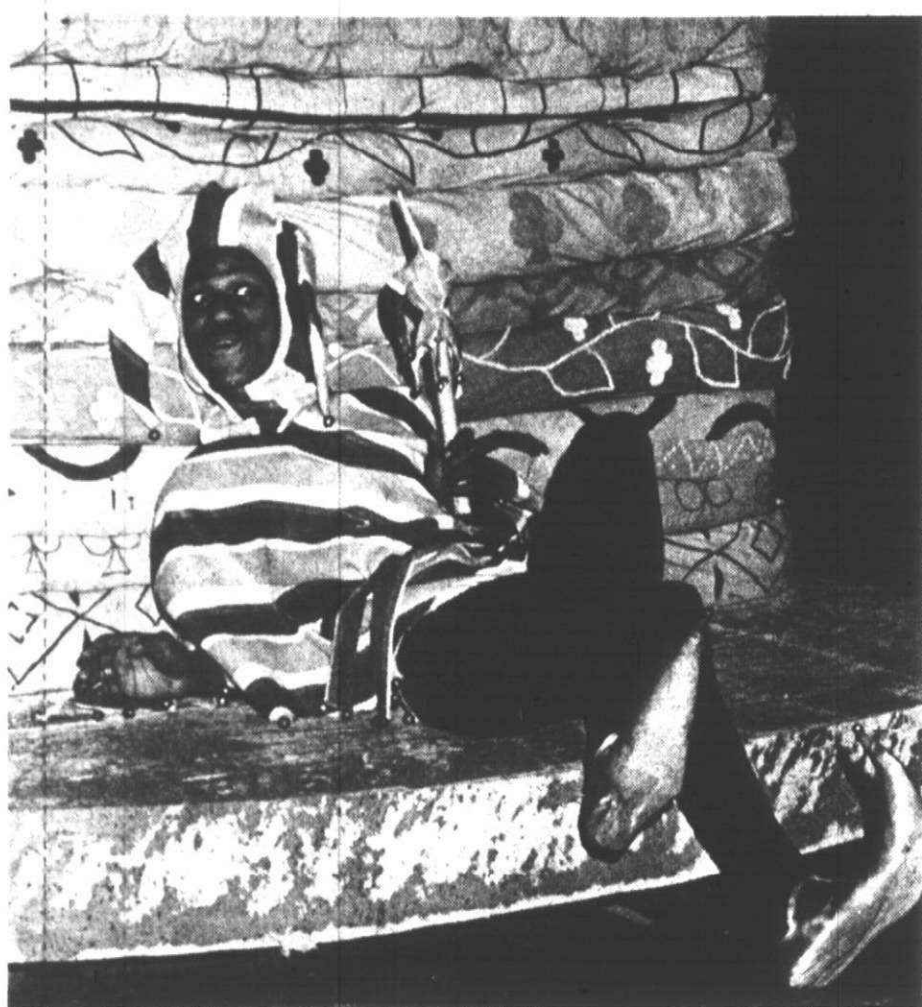

Greg Goldston as the Jester.



Among the cast members are (from left) Holly Wagner as Lady Larken, Alan Price as Sir Harry, and Jaimie Wieser as Lady Mabelle.

## CEP will present 'Once Upon A Mattress'

The musical comedy "Once Upon A Mattress," will be presented by the Plymouth Centennial Educational Park drama department April 8/9, 10.

The musical will begin at 8 p.m. each evening in Plymouth Salem auditorium, under the direction of Mrs. Gloria Logan. Tickets at \$2 each may be purchased from cast and crew members or at the door. There also will be a special matinee at 2 p.m., April 10 with tickets at \$1.50.

The musical is based on the famed fairy tale of "The Princess and the Pea." The tale is of a princess who, because of her noble birth, was so sensitive that she was unable to sleep on a bed of 20 downy mattresses when a single pea was placed beneath the bottom mattress.

Jay Thomson, Marshall Barer and Dean Fuller have used this story as a springboard to dive into a rollicking story which crackles with excitement of song and dance.

The Prologue, sung by the minstrel (Frank Mercieca), tells the story as most youngsters have heard it, explaining that it happened "Many Moons Ago." After warning the audience that this version doesn't cover all the facts, he shows us the story as it really happened.

The kingdom is in a sorry state. Placed under a witch's curse, King Seximus (Todd Barker) has been struck dumb and

"will never talk until the mouse devours the hawk."

After experiments which end in disaster, Queen Agrauin (Mary Ann Prechlik), a marathon talker, assumes power. She decrees that no one in the kingdom may wed until Prince Dauntless (Dave Shephard) is married to a "true princess of royal blood."

In a gallery of the castle, Lady Larkin (Holly Wagner) tells her handsome lover, Sir Harry (Alan Price), that marriage or no marriage they are going to be parents. To find a princess for Dauntless, therefore, becomes a matter of some urgency. Sir Harry promises to travel to the hitherto unexplored marsh and find a true princess.

News comes that Sir Harry has found a contender and the royal entourage awaits her arrival in the courtyard. Princess Winnifred (Kathi VanAernum) makes an impressive entrance—dripping wet. "Actually," she informs the astonished group, "I swam the moat."

Through a series of strange and funny incidents, we are led to a happy ending. The queen is punished, the lovers are united, and Winnifred at last falls asleep as the company reminds us that: "You can recognize a lady by her elegant air, but a genuine princess is exceedingly rare."

**Insulate**  
Save money on gas heating  
CALL YOUR INSULATION DEALER  
Consumers Power



## The Stroller

### Watch little things

By W. W. EDGAR

**LOOK for US!**  
APRIL 8 IN THE  
OBSERVER & ECCENTRIC  
NEW FANGLED  
SECTION  
7-MILE  
FARMINGTON CENTER

It's the little things that count. When The Stroller was a young lad in the intermediate grades back home in the Dutch country, his self-styled "old maid school teacher" kept repeating this statement at every opportunity.

Each time she did, there was a snicker among the students. But as the years wore on, The Stroller has witnessed the truth of the remark. And in many cases, it was a rather insignificant thing at the time that changed men's lives. In fact it was a rather small thing—the misspelling of a word—that played a part in his own career.

When he was about to set out on his own, not knowing exactly what he wanted to do, The Stroller took heart with an announcement that the postal system was planning to install home-delivery service and that an examination was to be held to select the mail carriers.

The announcement carried the interesting news that the successful carriers would have the opportunity to work their way up the promotional ladder and that, after so many years, they could retire for life on a pension.

What could be more enticing than that? THE STROLLER who was head of his class until he was forced to leave school

because of economic conditions, envisioned a bright future and his days of retirement in his little home town.

No competitor was more confident than he on the morning of the examination. He looked over the candidates and felt that he could beat any of them in any sort of competitive examination.

With Tom Fehnel, an old-time Pennsylvania Dutchman with a heavy dutch accent, in charge of the examination, it didn't seem difficult.

In less than an hour, The Stroller was the first one finished, and when he left it seemed all the others were struggling.

He was certain he would be the winner. But several weeks went by and there was no announcement of results. Finally, he could wait no longer and appealed to the postal officials for the verdict.

"You didn't win," the young lady in the office stated.

The Stroller couldn't believe it. He asked to see the papers to learn where he had failed.

"You missed in spelling," he was told.

That seemed odd because he had won many a spelling bee. But sure enough, he missed on the word "besiege." Because of the examiner's strong Dutch accent and the fact that the Dutch don't pronounce hard Gs, The Stroller thought the given

word was beseech. He spelled it that way. And on that little thing, his vision of a post-carrier and eventual retirement was blasted.

Years later, shortly after he began his stroll along the river of printers' ink, The Stroller's life was given a new turn when he had the privilege of meeting the late Edgar A. Guest, renowned Free Press poet. He was on a lecture tour and stopped off in our little town. And out of our short conversation came an invitation for The Stroller to join the Free Press sports staff. He accepted, and soon was on the way to a colorful career. It was just a short conversation, but it was the turning point in The Stroller's life.

Then there was the case of J. Fred Lawton, the perennial sophomore at the University of Michigan. He became one of the country's outstanding insurance men, all because of a speech he made at a Liberty Bond drive during World War I.

One of his listeners was J. L. Hudson, head of the famed department store. So impressed was he that he invited J. Fred to write all Hudson insurance. He did so until the day he died. It helped him write more than \$1 million of life insurance each year. All because he made a speech at the right time.

So, the "old maid school teacher" was right. It is the little things that count.



## Meets O'Hara

Michigan educators converged on Washington, D.C., recently to learn of new developments in the U.S. Office of Education and current legislation in congress. Samuel Ulsaker (left), administrative assistant for program planning, research and federal projects for Plymouth Community Schools, confers with U.S. Rep. James O'Hara.

**enjoy**  
THURS., FRI., SAT. NIGHTS  
THE MERRI RIVALS  
in the Merri-Bowl Lounge  
3950 FIVE MILE at Merriman, Livonia 427-2900

**FREE**  
Buy any Medium Pizza  
At the regular price  
**Pizza**  
Get Identical Medium PIZZA  
**FREE** PICK-UP  
**Little Caesars Pizza**  
One Coupon Per Customer At These Participating Locations Only!

<b>LIVONIA</b> Five Mile at Levan 525-5590	<b>FARMINGTON</b> Farmington Rd. at Grand River 478-7025 Northwestern at 14 Mile 851-2212	<b>PLYMOUTH</b> Sheldon Rd. at Ann Arbor Rd. 453-1000
<b>LIVONIA</b> Ann Arbor Rd. at Ann Arbor Tr. 484-3434	<b>NORTHVILLE</b> 11 Mile at Middlebelt 477-7900	<b>NORTHVILLE</b> 168 E. Main at Sheldon 348-0556

EXPIRES 4-15-76

VALUE HARDWARE • LIVONIA TRUE VALUE HARDWARE • LIVONIA TRUE VALUE HARDWARE

**Spring GARDENING TIME**

**74<sup>99</sup>**

**19" 3 1/2-HP ROTARY MOWER**

Powerful 3 1/2 hp, 4-cycle engine with recoil start. Remote control throttle. Sturdy 14-ga. steel deck; washout port for cleaning. Three cut heights; 6" rubber-tire wheels. Folding handle. Assembled. 40-196.

**"66" 5-H.P. TILLER**

**239<sup>88</sup>**

An easy-to-handle garden tiller for all your yard and garden preparation. Real digging stability — engine weight is directly over 16 tines — chews up hard ground fast. Controls on handle. T66-5

**3 H.P. TILLER \$192.87**

**2 SPD. • 5 H.P. TILLER WITH REVERSE \$279.88**

**5 MILE ROAD**  
at FARMINGTON ROAD

**LIVONIA True Value HARDWARE**

PHONE GA 2-1155 — 937-1611  
OPEN DAILY 9 a.m. - 9 p.m.  
SUNDAY 10 a.m. - 3 p.m.

DINERS CLUB  
Master Charge  
BANKAMERICARD

# Cigarette Flavor Decoded.

Scientists isolate tobacco ingredients most essential to taste  
— 'Enriched Flavor' packed into new low tar MERIT.

By "cracking" cigarette smoke down into separate ingredients, researchers at Philip Morris have discovered very special "key" flavor units that deliver taste way out of proportion to tar.

The discovery is called 'Enriched Flavor.'

The cigarette packed with 'Enriched Flavor' is MERIT. At 9 mg., one of the lowest tar levels in smoking today.

Yet MERIT actually packs the taste of cigarettes having *more* tar.

Up to 60% more tar.

If you smoke, you'll be interested.

#### Tests Verify Taste

Thousands of smokers were tested. The results were conclusive: Against five current leading low tar brands, 9 mg. MERIT was reported by a significant majority of smokers to deliver more taste\*.

Repeat: deliver more taste.

In similar tests against 11 mg. to 15 mg. menthol brands, a significant majority of all smokers tested reported MERIT MENTHOL delivered as much — or more — taste.

MERIT and MERIT MENTHOL.

Both packed with 'Enriched Flavor.'

Both lower in tar than 98% of all cigarettes sold today.

Both turning in extraordinary flavor performances against higher tar competition.

You've been smoking "low tar, good taste" claims long enough.

Now smoke the cigarette.

MERIT.

\*American Institute of Consumer Opinion. Study available free on request. Philip Morris Inc., Richmond, Va. 23261.

© Philip Morris Inc. 1976

9 mg. "tar," 0.7 mg. nicotine av. per cigarette by FTC Method.

Warning: The Surgeon General Has Determined That Cigarette Smoking Is Dangerous to Your Health.

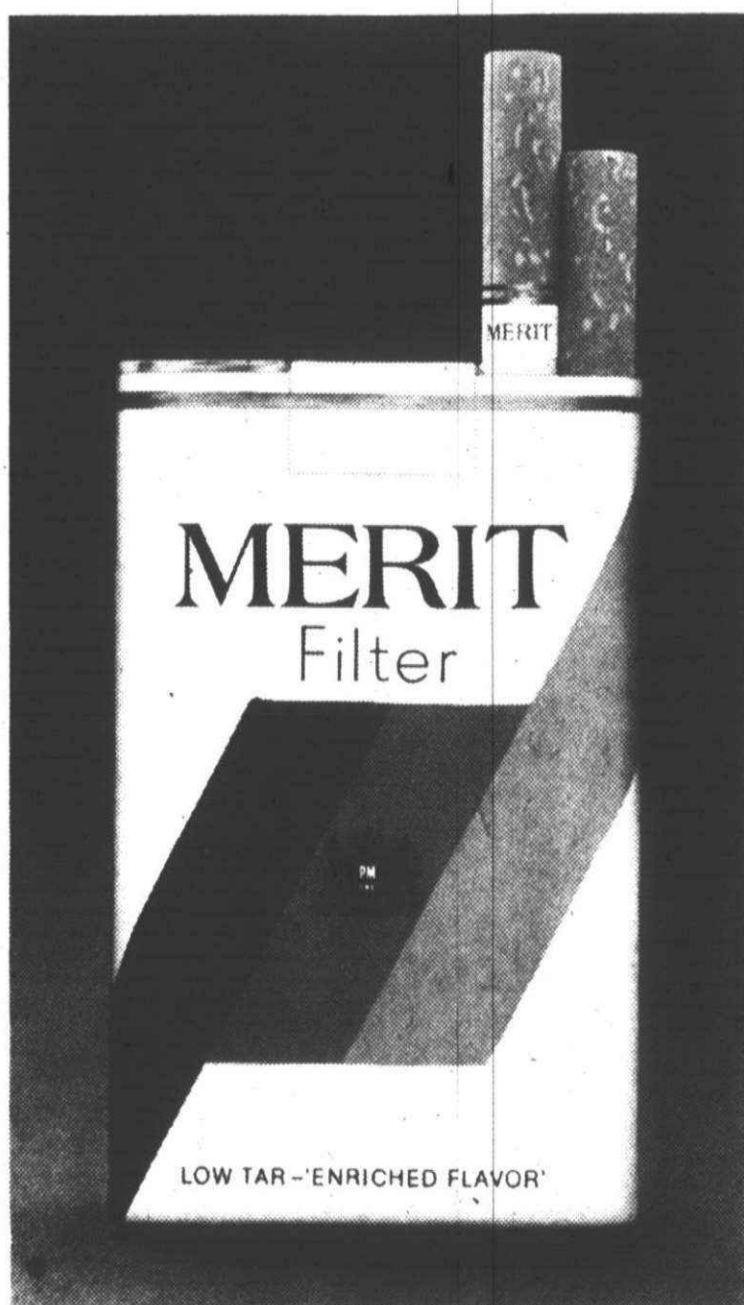

MERIT and MERIT MENTHOL

AVAILABLE ONLY AT: ANN ARBOR RD. NEAR HAGGERTY ROAD • FORD ROAD AT SHELDON ROAD

SALE PRICES GOOD NOW THRU SATURDAY

# K Mart

OPEN DAILY 10-10; SUNDAY 11-6

### K MART'S ADVERTISED MERCHANDISE POLICY

Our firm intention is to have every advertised item in stock on our shelves. If an advertised item is not available for purchase due to any unforeseen reason, K Mart will issue a Rain Check on request for the merchandise to be purchased at the sale price whenever available or will sell you a comparable quality item at a comparable reduction in price. Our policy is to give our customers' satisfaction always.

S. S. KRESGE CO.

## HERE'S PROOF YOU SAVE MORE!



LIMIT 2  
**SHOWER LINERS**  
Our Reg. 2.37  
Thru Sat.

### 1<sup>17</sup>

6x6 magnetized, waterproof curtain. 100% virgin vinyl.

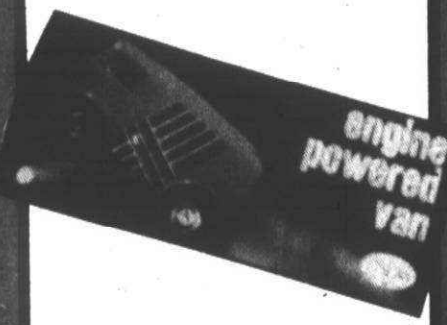

**GAS POWERED VEHICLES**  
Our Reg. 9.37  
Thru Sat.

### 6<sup>37</sup>

Your choice of planes, vans, pick-ups.



**POPCORN PANELS**  
Our Reg. 2.44  
Thru Sat.

### 1<sup>97</sup>

50% polyester/50% acetate. 40x81" length. White, gold, egg shell, brown.

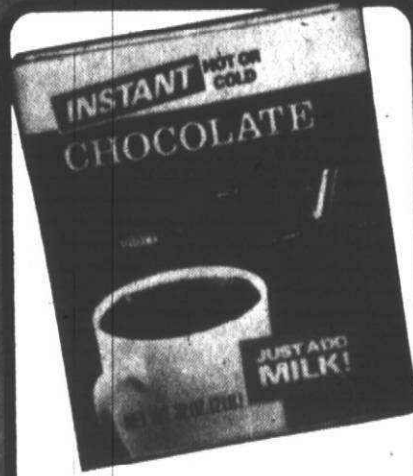

**CHOCOLATE MIX**  
Our Reg. 1.28  
Thru Sat.

### 94¢

32 oz. instant chocolate mix. Just add milk!



**ODOR EATERS®**  
Our Reg. 1.27  
Thru Sat.

### 88¢

Odor-destroying cushion insoles. Removes odors from feet, socks, shoes.

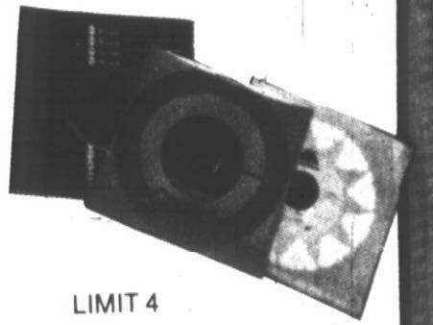

LIMIT 4

**RECORDS**  
SALE PRICED  
THRU SAT.

### 80¢

30 TOP ROCK N ROLL 45 RPM RECORDS

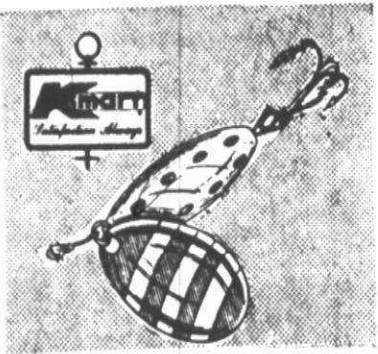

**FISHING LURES**  
Our Reg. 58¢-1.07  
Thru Sat.

### 3/\$1

Many different styles, sizes, and weights to choose from.

**LADIES SHORTS**  
Our Reg. 3.96  
Thru Sat.  
**2<sup>88</sup>**  
Early bird special! Polyester shorts in Jamaica or short-short styles. Colors galore. Misses sizes 8-18.

**GIRLS SHORTS**  
Our Reg. 1.96  
Thru Sat.  
**1<sup>44</sup>**  
Nylon or polyester little girls shorts, with elastic waist. Fun colors; in sizes 4-14.

**SAVE** on  
Prescriptions  
at  
Pharmacy  
AT MOST K-MARTS

**CHARGE IT!**  
WE HONOR

master charge  
THE INTERBANK CARD

BANKAMERICARD

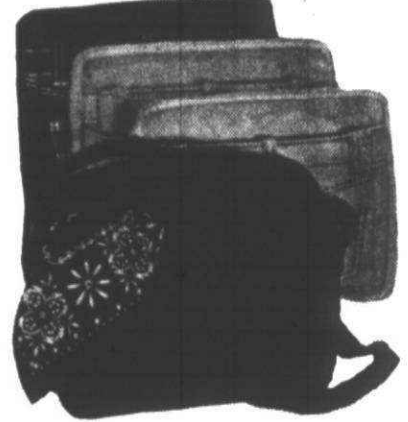

**DENIM HANDBAG**  
Our Reg. 4.97  
Thru Sat.

### 3<sup>50</sup>

Made of durable canvas-like material. Adjustable shoulder strap, with outside "Jeans" pocket. Available in the Fashion Accessory Dept.



**10-SPEED BICYCLE**

Our Reg. 68.84  
Thru Sat.

### 59<sup>88</sup>

Dual caliper brakes, single lever, side pull. 26" bicycle for men, women, boys, and girls.



**SPORTS WATCHES**

Our Reg. 12.96  
Thru Sat.

### 7<sup>96</sup>

For active people on the go! It's water resistant, and has an automatic calendar dial.



**CALCULATOR**  
Our Reg. 14.96  
Thru Sat.

### 10<sup>76</sup>

8 digit calculator, AC/DC. Adds, subtracts, multiplies, divides—911 Calculator



**SOAP PADS**  
Our Reg. 83¢  
Thru Sat.

### 52¢

30 count pak steel wool pads.



**COOKIES**  
Our Reg. 39¢  
Thru Sat.

### 26¢

Choose from a large variety of tasty cookies.



**ACTIVITY PAD**  
Thru Sat.

### 22¢

Variety of fun and activity pads for your child to choose from.

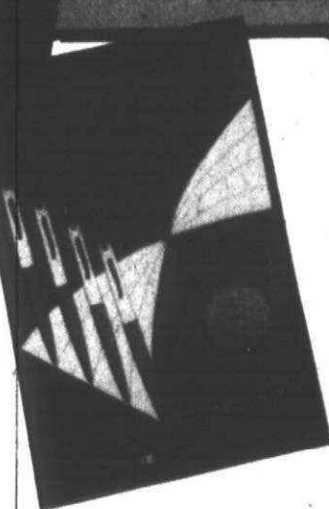

**WRITING TABLET**  
Our Reg. 97¢  
Thru Sat.

### 46¢

Ruled or plain 6x9" tablet. Ideal for ball pen and fiber tip pen.



LIMIT 2

**BUTANE MATCH**  
Our Reg. 87¢  
Thru Sat.

### 49¢

Disposable, long lasting butane. No refilling.

AVAILABLE ONLY AT: ANN ARBOR RD. NEAR HAGGERTY RD. • FORD ROAD AT SHELDON ROAD

# the view

from 461 s. main

**THE DATE OF** the April meeting of the Plymouth Historical Society is Thursday, April 8, not a week later as published in the monthly calendar assembled by the area bicentennial commission.

The society will meet at 7:30 p.m. in the Historical Museum. Guest speaker will be Sandy Hicks of the University of Michigan Botanical Gardens, whose subject will be the use of herbs down through the years.

**GEORGE AND BETTY HUDSON** admitted they were a little disturbed when a beat-up car and rented trailer arrived at the Robert Baxters', next door on Burroughs. The knew the Baxters weren't home, and they didn't want anyone loading up their furniture and making off with it in their absence.

As it turned out, the visitors were Mr. and Mrs. James Neubacher—Marg Neubacher is Bob Baxter's sister. The Neubachers had been in the basement of their West Bloomfield home when the tornado struck. When they opened the door at the top of the stairs to see what the "roar" was all about, they were standing outdoors.

They plan to rebuild their home, and are full of praise for the way everyone pitched in to help. The boys scouts cleaned up the debris, Marg's tennis racket was found half-a-mile away and returned, Jim's wallet was returned with everything intact.

It makes you stop and think. What would you do if you walked upstairs one day and discovered—nothing? Without money, drivers license, checkbook, bank books, charge plates, how do you identify yourself? The Neubachers had the added problem of their bank being hit by the same catastrophe that wiped them out.

**CATHERINE WESSELS** of Plymouth Township will join 3,300 bicycle riders from 32 states and Canada May 8 and 9 in the 15th annual tour of the Scioto River Valley, the biggest weekend bicycle touring event in America.

The tour begins at the state capitol building in Columbus, Ohio. The riders travel south along the Scioto River Valley for 105 miles until they reach Portsmouth, the overnight location. Food and rest stops are provided by the organizers, the Columbus Council of American Youth Hostels, at 25-mile intervals. In Portsmouth, the riders will enjoy a banquet dinner and get a good night's sleep.

On Sunday morning the riders get an early start and follow the same route back to Columbus. Average riding time for the full 210 miles is about 20 hours, or 10 hours each way. Tour finishers have ranged in age from six to 71.

**GOOD NEWS** from Gae McCord in Naples, Fla. where her husband Denver has been hospitalized because of a heart attack.

According to Nan Cooper, Gae's sister, the doctors expected to move their patient out of isolation sometime over the weekend.

"Gae said he is beginning to worry about her driving to the hospital at night, and where she parked the car," said Mrs. Cooper, adding that he also is becoming bored with his forced inactivity.

For those who don't have the McCord's address, it is: D.P. McCord, 10573 Gulf Shore Rd. N., Vanderbilt Club, 103, Naples Fla. 33940.

**DAVIS HILLMER'S** contribution to the artists' sketchbook now available at the Plymouth Historical Museum may surprise those who considered photography his only art form.

Hillmer's pencil drawing of a balloon ascension was done especially for the collection.

"I have a photograph of a balloon ascension that I took in August, 1912," said Hillmer. "It was a gala day when the firemen had their water battle on Main Street. The balloon was an added attraction to bring out a crowd. It went up on the back of the lot where the Mayflower Hotel now stands."

The artist added that at one time he had modeled in clay and had done some pencil portrait work.

**RESERVATIONS** requests for the April 25 performance of the Shaker folk ballet with the Plymouth Symphony Orchestra are coming from as far away as Cincinnati, Ohio.

Susan Kreig, a graphic designer in Chicago, has the most extensive collection of Shaker photographs in the nation. She is bringing 25 of her photographs to Plymouth for the premiere performance of "The Burning Tree," commissioned by the Plymouth Symphony Society as a bicentennial work.

At first, she was going to send the collection and gave instructions on how it should be displayed. But, she became so entranced with the new Shaker piece, she decided to come and see for herself. She told friends in Cincinnati about it and they decided to come, too.

Her collection will go to New York, the Detroit Institute of Art and Louisville after the Plymouth showing.

**A CALL FROM** Ilene Boze of the Livonia Mall the other day. "Do you think anyone in the Plymouth-Canton area would be interested in a farmers market at the mall this summer?" She went on to say it would be a cool place to set up a stand to sell any extra produce and the mall shoppers would appreciate the service.

To voice your reaction to the idea, call Mrs. Boze at 476-1160.

**A BICENTENNIAL** consumer tip comes from Larrestine Trimm, marketing information specialist for the Michigan Department of Agriculture.

Mrs. Trimm says, "Early American cooks prepared 'Rhubarb Delight,' a spicy, sweet bread crumb mixture flavored with graded lemon peel, layered alternately with diced rhubarb and baked until the fruit is tender."

One of the most delicious ice cream toppings was served by Joann Hulce—bright pink rhubarb sauce—perfect complement to ice cream.

Can't beat the year's first batch of rhubarb sauce as a spring tonic. It's better than sulphur and molasses any day.

# Plymouth LIFE

Monday, April 5, 1976

(P.C.) 1B



Tom Grace's smile was a little forced as Darcy took shears in hand, but he approved the end result.



After taking care of waist-length tresses, Lynn Lyon enjoyed the freedom and bounce of her angle wedge cut. (Staff photos by Elinor Graham)



Margaret Ivan, Audrey Thomas, Barbara Rubadue and Joyce Kennedy watched their fellow club members get the new bouncy look.

## New hair styles have clean, bouncy look

"I feel absolutely light-headed," said Lynn Lyon as she tossed her head and her smooth wedge-cut hair style flipped back into place. Mrs. Lyon had very long hair for 18 years—almost waist length. As one of the members of the Plymouth Newcomers Club, who volunteered as a model for their hair fashion show, she now sports a short angle cut—and she loves it.



Laura Kolb (left) has her hair shaped by Janet Childers. Sandy Page (upper right) before her transformation. The Newcomers Club members (below) after their new hair stylings.

After a luncheon meeting in the Plymouth Hilton Inn, club members and guests witnessed transformations in both men's and women's coiffures by hairdressers from House of Glamour and Mayflower beauty salons.

Pat Hahn demonstrated that the all-American healthy look was in. Easy-care styles with a bouncy look that can be blown dry and are dependent on a good cut and conditioning.

The youthful, shiny look was reminiscent of Olympic gold medalist Dorothy Hamill's locks which always seemed to fall into place after her figure-skating whirls.



Claudia Fetterman batted her eyelashes for fellow members. They were the glued-on type which stay in place for several months.

Mrs. Hahn said bangs were important this year, emphasizing the eyes. "Good red lips and healthy cheek color add to the outdoor look," according to Mrs. Hahn, who recently attended an international convention of hair stylists in New York.

## Clubs in Action

### PILGRIM GARDEN CLUB

Pilgrim Garden Club will meet at 7:30 p.m. Thursday, April 8 in Gallimore School, 8375 Sheldon. Guest speaker will be Mrs. Lester Robinson, whose subject will be "Herbs." Janet Dersey says new members are welcome.

### PLYMOUTH WOMAN'S CLUB

Tickets now on sale for annual Woman's Club breakfast theater Thursday, April 29—breakfast served in Masonic Temple followed by "Singin' in the Rain" in Penn Theater. Tickets are \$3 and may be obtained from club members or by calling 453-1909 or 459-2425.

### 3 CITIES ART CLUB

Three Cities Art Club will open its April 14 meeting to the public when Howard Eiter will give a two-hour watercolor demonstration. One of Michigan's better known water colorists, Eiter specializes in landscapes, and his works are included in private collections throughout the country. He will use overhead mirrors in his demonstration. Club will meet at 7:30 p.m. in the

Community Credit Union, 500 S. Harvey. Donation will be \$1.

### FARM & GARDEN

The Plymouth Branch of the Michigan Division of the Woman's National Farm & Garden Association will meet Monday, April 12 at 12:30 p.m. in the home of Mrs. Louis Truesdell, 9211 Maple Tree Dr. Guest speaker will be Steve Mansfield of Heide's Flowers and Gifts, who will discuss Easter arrangements for the home.

### PLYMOUTH-NORTHVILLE PWP

Plymouth-Northville Parents Without Partners will meet April 9 in the American Legion Hall, 100 W. Dunlap Street, Northville. Speaker will be the Rev. Robert Schaden of Neuman House at Schoolcraft College. His subject will be "Self Image—The Labeling Game." Coffee will be served at 8 p.m. followed by a business meeting at 8:30, program at 9, and an afterglow.

The club is organizing a mixed golf league which will begin play Sunday, April 25 at San Marino or Brookline. Call Mary Richards, 624-5343, for details.

## BPW members to model old, new fashions

Hand-picked fashions from New York will be featured at 8 p.m. Wednesday when members of the Plymouth Business and Professional Women's Club present their annual fashion show in the Plymouth Cultural Center, 525 Farmer Street, Plymouth.

They also will show a collection of colonial gowns, but with a different approach. Fashion commentator Joan Silver will point out similarities in the old and the new. An 1850s afternoon dress, a prize winner at Greenfield Village's Muzzle-Loader Festival, will have the same bell sleeve treatment as a 1976 model.

Ellice Kulick, Marg Brillhart and Mrs. Earl West will supply the antique fashions.

Fur fashions and hats will be modeled and one guest will receive a Norwegian blue fox shrug.

Barb Harbin, who is in charge of refreshments for the event, plans to serve French pastries.

Tickets are available from club members or at the door. Admission of \$1.50 includes fashion show and refreshments.



Art juror

Peggy Midener, painter, lecturer and critic, will be juror of the art show at the Plymouth Cultural center April 9-11. Mrs. Midener studied painting and drawing with Sarkis Sarkisian and Guy Pallazola. Her works are represented in the Detroit Institute of Arts, Butler Fine Arts Museum, Youngstown, Ohio, and in many private collections throughout the country. Her husband is sculptor Walter Midener, director of the Center for Creative Studies in Detroit.

## First Wednesday at The Stores

WEDNESDAY, APRIL 7  
10:30 A.M., EAST COURT

It's an Easter parade of fashion! See the latest in spring accessories — Easter bonnets and bags, sandals, and a fresh new crop of scarves for fanny wrappers and head wrappers. A procession of ideas for casual and formal evening wear, too. Children's fashions highlight this parade, and the Easter bunny will pay a special visit. Free coffee, Easter eggs for the kids, door prizes. Come early for best seating.

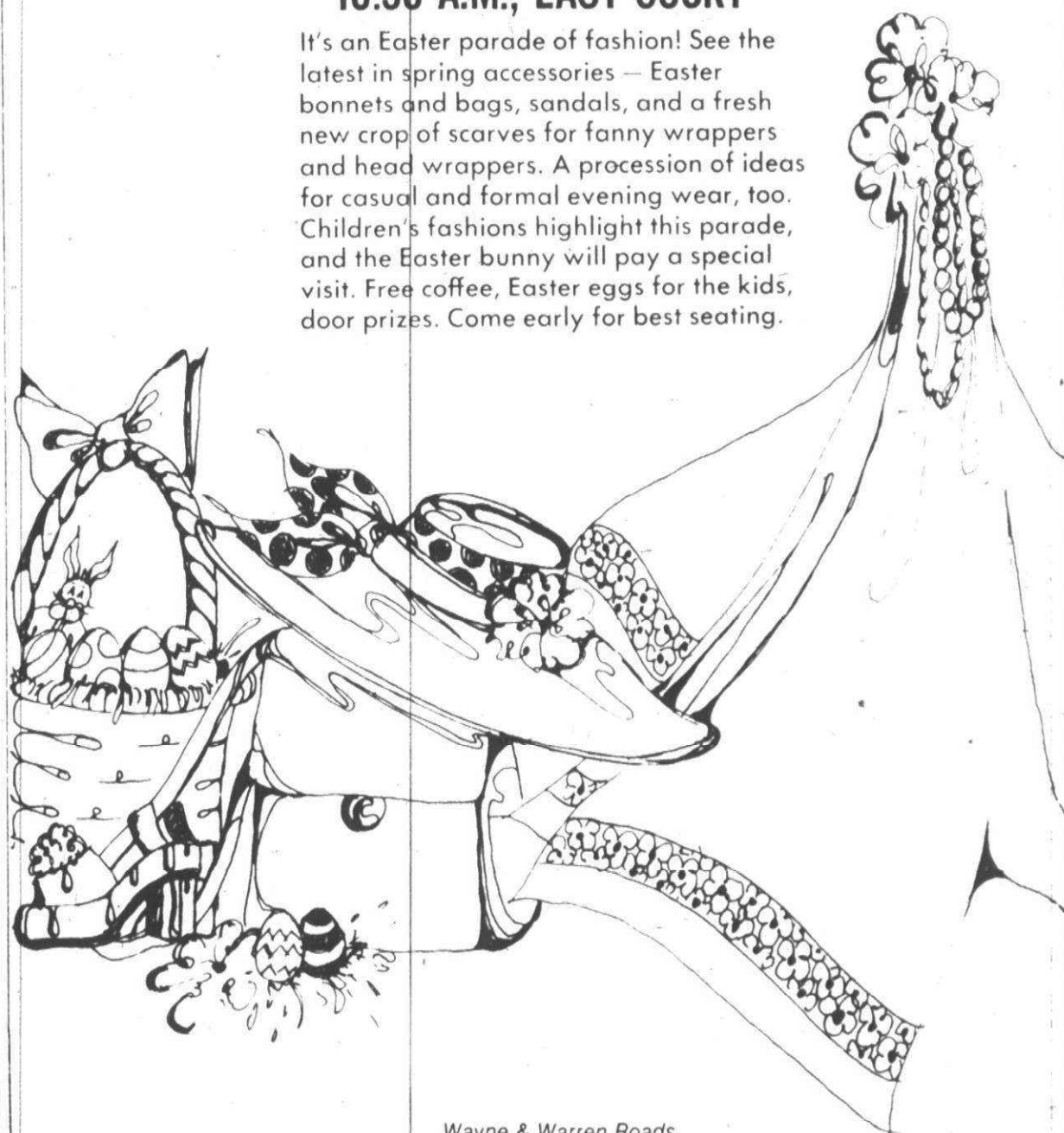

Wayne & Warren Roads  
Mall Hours: Daily 9:30-9 p.m.; Sun. 11:00-6:00 p.m.

# westland center

**O'Connor-Tigani**

Mrs. Thomas John O'Connor Sr. of Ann Arbor announces the engagement of her daughter Judith to Gregory James Tigani, son of Mr. and Mrs. Gregory J. Tigani of Floral Street, Livonia.

Both are students at Cleary College in Ypsilanti. The bride-elect, also daughter of the late Mr. O'Connor will graduate in June and is a member of Gamma Eta Sigma sorority. She is employed by Huron Valley National Bank.

Her fiancé belongs to Sigma Phi Chi business fraternity and the Ann Arbor chapter of the National Association of Accountants.

They plan to be married June 19 in St. Francis of Assisi Catholic Church in Ann Arbor.



MR. AND MRS. DENNIS GEORGE BRIDSON (Cheryl Ann Sorensen)

**Bridsons have home in Wixom**

Mr. and Mrs. Dennis George Bridson have a home in Wixom following their marriage in the Garden City Presbyterian Church with the Rev. Gareth Baker officiating.

Mrs. Bridson is the former Cheryl Ann Sorensen, daughter of Charles and Mary Ann Sorensen of Garden City. Her husband's parents are George and Dolores Bridson of South Lyons.

Given in marriage by her father, the bride wore a white velvet gown with mandarin collar and lace and pearl trim. The same lace trimmed her veil and she carried a bouquet of dried flowers—red roses and white baby's breath.

Her attendants wore pink dresses with hooded velvet jackets and carried dried bouquets with red and pink roses and white baby's breath.

Marilyn Hayes was maid of honor and the bridesmaids were Cathy Sorensen, Jo Arjn Remer, Julie Bridson and Sue Hines.

Dave Willacker was best man and the groomsmen were Dave Bridson, Mike Martin, Gilbert Blevins and Arnold Remer. The guests were seated by four brothers of the bridal pair, Paul and Brian Sorensen and Jamie and Jeff Bridson.

Among the guests at the wedding and Hawthorne Valley Country Club reception were Mr. and Mrs. George Wagonack of

St. Helen, Mich., and Mrs. Cecilia Sorensen of Algonac, all grandparents of the bride.

The honeymoon trip was to northern Michigan. The new Mrs. Bridson is a 1973 graduate of Garden City East High School and her husband attended Oakland Community College. Both are employed by Automotive Specialties in Wixom.

**SHOWERS BANQUETS BAR MITZVAHS**  
**BANQUETS WEDDINGS**  
 BUFFETS OF OVER 30 HOT & GOLD ITEMS **\$5.95**  
**477-2686 CORDOBA**  
 BANQUET FACILITIES FOR UP TO 200 7 MILE & MIDDLEBELT

**9:30-5:30 Mon. thru Sat. LAMPCRAFT, INC.**  
 • Lampshades • Lamps & Fixtures • Lamp Repairing  
 If there is a lampshade you want but can't find — TRY US!  
 We feel we have the finest assortment of replacement lampshades in the world. No one could have them all. But, we are trying!  
 Please bring your lamp to buy a replacement lampshade.  
 4312 N. Woodward Royal Oak, between 13 and 14 Mile Rds. 549-1399  
 14 Mile Woodward 13 Mile  
 Daily Openings  
 135 Romeo Rd. Rochester, slightly east of Rochester Rd. 1 Light No. of Walton 651-5714

**FINAL SALE WEEK**

**Save now, look great later with a new perm.**

Organicore Reg. 17.50 **12.66**  
 Textra Reg. 22.50 **16.66**  
 Both by La Maur

**BEAUTY SALON**  
 Use Wards Charg-all.

**MONTGOMERY WARD**

**WONDERLAND CENTER**  
 Plymouth at Middlebelt 427-1600

**HOW plans coffee session**

Happiness of Womenhood, Inc. will hold a membership coffee from 10 a.m. to 2 p.m. Wednesday, April 7, at the home of its national director, Mrs. Patt Barbour, 17570 W. Outer Drive, Dearborn Heights.

Organized in 1971, HOW was the first national organization to oppose the Equal Rights Amendment.

For further information contact Mrs. Barbour.

**'Ladies' Day Out' begins**

Registration is now being taken for the spring Ladies Day Out program offered at Northwest Branch YWCA, 26940 Grand River, Redford Township. The nine-week term will begin April 6.

and variety to menu planning and a special physical fitness class, swim, supervised calorie luncheon and volleyball game will help trim up for the vacation season.

The program offered Tuesdays, Wednesdays and Thursdays offers a choice of activities mornings and afternoons.

Human Potential will help women discover more about themselves in a positive approach, and a rap session and book review concerning topics of the day will offer mental stimulation.

Added to the basic class program this term are some special interest subjects. By demand, an astrology class will be offered during the day program, first aid will help prepare mothers for summer. "Cooking with a Flair" will add spice

Nursery service for infants and preschoolers is available.

For details about other subjects offered during Ladies Day Out, call the YW.

**Nursery opens enrollment**

Good Hope Nursery School in Garden City is now taking applications for the 1976-77 school year.

year-olds meet Wednesday and Friday from 9-11:15 a.m.; and four-year-olds meet from 9-11:15 a.m. or 12:45-3 p.m. on Tuesday and Thursday.

Enrollment in classes held in Good Hope Lutheran Church, 28680 Cherry Hill, is open to three- and four-year-olds. Three-

For further information contact Mrs. Sally Neslund, 31908 John Hawk, Garden City.

**WHY LIVE IN SOMEONE ELSE'S HOME ?**

**\$38,900**

Are you frustrated at looking at USED homes? Come out and talk to the professionals at **ALLSTATE HOMES**. We will show you how you can afford to build a custom home... the way you want it! We are experts in "Energy Homes", unique designs and quality construction.

Designs Building Financing

**Allstate Homes**  
 333 E. Grand River Brighton 227-2440  
 3881 Highland Road Pontiac 681-5511

**Carpet Sale**

*a seldom-offered opportunity to own luxurious Berven of California Carpet at great savings!*

**SALE 2 WEEKS ONLY**

Carpet is such a major purchase for the home that we believe you would want to know why we consider Berven Of California "better carpet."

You would ordinarily expect to pay more for Berven of California carpet for the same basic reasons that all "better merchandise" is higher priced. We've listed some of those reasons below as they apply to carpet. They emphasize the added value you will receive. To be completely convinced, visit our store soon or invite us into your home to show you the superb styling Berven offers you and to point out the fine tailoring details and craftsmanship this quality mill provides. But, don't delay! We can't emphasize enough that this is a most special sale with savings that we may never be able to repeat!

<b>MYSTICS</b> A densely tufted plush texture of pettily slender yarns in 19 natural colorations regularly \$17.95 <b>now \$15.45 yd.</b>	<b>BEAU PETITE</b> A warm, medium plush texture delicately spiced with interesting color accents regularly \$11.95 <b>now \$9.45 yd.</b>
<b>PROVOCATIVE</b> Choose from 21 subtle colorations in a splashy texture of plump and slender nylon yarns regularly \$12.95 <b>now \$10.45 yd.</b>	<b>DRIFTING SANDS</b> Subtly two-toned sculptured silky nylon in 17 lovely tones regularly \$13.95 <b>now \$10.95 yd.</b>

**Colonial House**  
 19532 W. McNichols (6 Mile) East of Evergreen  
 KE 2-7900  
 Open Monday, Thursday & Friday 'til 9 P.M.

**Daily Interest Statement Savings lets you make deposits, withdrawals, and earn daily interest—all without a passbook.**

The convenient, modern way to bank is with a Daily Interest Statement Savings account at Detroit Bank & Trust.

It's convenient, because there is no passbook to bother with. You don't have to have one with you to make deposits or withdrawals. And you never have to worry about losing it.

It's modern, because you get a detailed, computerized statement of your account's activities every interest quarter—deposits, withdrawals, interest earned and current balance. It's all there in easy-to-read form. And it's mailed to your home. And Daily Interest Statement Savings is smart to have because you earn daily interest on your savings. Your money is compounded and paid quarterly at a 5% annual interest rate, earning interest from day of deposit to day of withdrawal.

To start your Daily Interest Statement Savings account, just tell your DETROIT BANK-er you want to sign up. Of course, your account is insured to \$40,000 by the FDIC.

For daily interest and the convenience of a statement account... it pays to know a DETROIT BANK-er better.

**DETROIT BANK & TRUST**  
 Member FDIC

**you ought to know a DETROIT BANK-er better**



**For Channel 56 auction**

Don Barrett of Rollie-Barrett Chrysler-Plymouth in Livonia, donated a citizen's band radio for the auctioning to support Channel 56 this week. Collecting it is Guyla Doumanian of

Livonia, who has served as general chairperson for the Channel 56 volunteers in the north-west Wayne County area. (Staff photo by Bob Woodring)

**Clubs in Action**

**ALPHA OMEGA**  
Detroit women of Alpha Omega will hold their annual election meeting at noon Tuesday, April 6, in Roberto's Restaurant, 2485 Coolidge, Berkley.

Eileen Berris will review the book "Anya." Reservations may be made with Mrs. Ronald E. Michaelson, 34038 Glouster Circle, Farmington Hills.

**AUDUBON SHOW**  
Tome Notebaert, vice president of the Detroit Audubon Society, will give a slide presentation on birds for the meeting of Matthew United Methodist Church, 30900 Six Mile, Livonia.

Notebaert lectures to raise funds to save endangered species of birds. Guests are invited to this meeting, and those planning to attend should call Mrs. Edward Trembath, 18744 Comstock, or Mrs. James Wilkinson, 16717 Wayne.

**SORORITY SONGFEST**  
The Northwest Suburban Alumnae chapter of Alpha Omicron Pi will meet at 8 p.m. Thursday, April 8, in the home of Helen Knight, 25897 Ridgewood, Farmington, for a songfest of sorority music with members of the Beta Pi collegiate chapter from Eastern Michigan University.

Alumnae who wish to attend should call Mrs. Lee Wollgast, 40992 Ivywood, Plymouth.

**BICENTENNIAL DANCE**  
The bicentennial committee of the Wayne-Westland Democratic Club will sponsor a dinner and dance beginning at 7

p.m. Saturday, April 10, in the Local 900 UAW hall, 38110 Michigan, Wayne.

There will be dancing from 9 p.m. to 2 a.m. Tickets are \$7.50 a couple and cover pretzels, chips, beer and setups. Make reservations with John Auten, 7304 Gilman, Westland.

**COIN CLUB DISPLAY**  
The Livonia Riverside Coin Club will present a bicentennial coin display from 1:30-4:30 p.m. Sunday, April 11, in the Senior Citizen Center, Farmington Road just south of Five Mile.

There will be no admission charged for the display of new bicentennial 1776-1976

coins as well as early American coins, token, medals and stamps.

**SUBURBAN LEAGUE**  
Members of the Redford Suburban League will hear a talk by Jim Hoke, hypnotherapist, at their meeting Wednesday, April 14, in Vladimir's restaurant, Farmington Hills.

Hoke will discuss the use of hypnosis as a means of helping people stop smoking or lose weight, and he will use several members of his audience for mini-sessions on stage.

Members and guests should make reservations with Mrs. Lawrence Glueck.

**Volunteerism is focus of seminar**

The first general showing of a new movie on volunteerism and explanation of a projected booklet on community resources will be featured in a seminar scheduled Thursday, April 8 by the Livonia Office of Volunteer Energies.

The seminar will be held from 12:30-4 p.m. in the Senior Citizen Center at Five Mile and Farmington Road, Livonia.

Joan Duggan, coordinator for the LOVE office, said all organizations and agencies that can use volunteer help, or have mem-

bers willing to donate services, are invited to participate.

Those that have not yet made reservations are asked to do so by calling the LOVE office.

The program will begin with the showing of a film advocating volunteerism produced in the LOVE office.

The film, Mrs. Duggan said, was funded by federal money given in a mini-grant after the office had completed its first successful year of operation. John Roberts of the LOVE staff is producer.

"The film is about Livonia people and groups," Mrs. Duggan added, "but it is to be made available for use by the federal agency to show how such an office can be set up."

**'Recycling women' topic for SC forum**

The Schoolcraft College Open Forum Series will continue on April 8 with a program entitled Recycling: How are Mature (45 plus) Women Coping?

A panel consisting of volunteers Audrey Cunningham, Gerry Dodds and Dorothy Jane Gaitskill will share mid-life changes they have made and will discuss various options and resources available to mature women in today's world.

Ms. Cunningham is a volunteer in Plymouth and operates her own business. Ms. Dodds sells real estate and is a volunteer at the College's women's resource center.

Ms. Gaitskill is a staff member with the Wayne County Office on Aging Senior Citizen Work Experience Program. She is also an undergraduate student majoring in gerontology at Madonna College.

The program is scheduled at 8 p.m. in Room 220 of the Liberal Arts Building. No registration is necessary and the Open Forum Sessions meet without charge.



**meijer beauty salon**



**Happy Easter**

You won't be needing that Easter bonnet this year! You can have beautiful hair instead, thanks to the fantastic Redken product line and your coiffure designers at Meijer Beauty Salon.

Even the Easter Bunny will be visiting Meijer this year for a new "HARE-DO". Join the parade!

COMPLETE REDKEN RETAIL CENTER!!!

Open Mon. thru Fri. 8 a.m. to 9 p.m.  
Sat. 8 a.m. to 6 p.m.

CALL 981-0846 FOR APPOINTMENT TODAY  
45001 Ford Rd.

*Süheyla and Jameela*

Invite Teachers, Students of Danse Orientale to ART WORLDS III ANNUAL FESTIVAL / WORKSHOP

"Rites of Spring"

APRIL 23 - 25, 1976

Guests: *Dahlana* - Chicago

*Maria Morca* - Toronto

*Dinara* - Bloomington

Seminars in Middle Eastern Music - Dance - Performance - Gala Opening Party -

Write for Program: 213 1/2 S. Main St., Ann Arbor, Mi. 48108 (313) 994-8400

**STAN'S**

**SALE GOOD APRIL 5th-10th**

**KENT ROASTED & POLISH KIELBASA** 99¢ lb.  
**CHICKEN BREASTS** BACK ATT. 79¢ lb.  
WITH WING ATT. 63¢ lb.

**PESCKE SLICED COOKED HAM** 79¢ 6 oz. pkg.  
**CHICKEN LEGS** BACK ATT. 49¢ lb.  
**WHOLE CHICKENS** 49¢ LB.

**DELMONICO STEAKS** 2.49 lb.  
**RIB STEAKS** 2.49 lb.

**CUBE STEAKS** 1.59 lb.

**STANDING RIB ROAST** 1.79 lb.

**THURSDAY ONLY • APRIL 8**  
**CABBAGE** 9¢ lb.  
**GROUND CHUCK** 89¢ lb.  
**MICHIGAN POTATOES** 10# 99¢

**HEAD LETTUCE** 3/\$1  
**VINE RIPE TOMATOES** 49¢ lb.

**FROZEN TREE SWEET ORANGE JUICE** 12 OZ. 49¢  
**PEPSI** 16 oz. 8 Pak N.R. DIET. REG. OR PEPSI LIGHT 1.49

**FRESH FLORIDA CORN** 12¢ ear  
**YELLOW COOKING ONIONS** 3 lbs 39¢

**HEINZ KETCHUP** 20 oz. 53¢

**50 lb. BAG UNCLASSIFIED MICHIGAN POTATOES** 2.79

**STAN'S Garden Center**  
COMING SOON  
38001 ANN ARBOR RD.  
464-0410

**"Your Complete Food Center"**  
**38000 ANN ARBOR ROAD LIVONIA**  
**464-0330 MON.-SAT. 9-9 SUN. 10-5**

# Where There's Life

**SPECIAL ATTRACTIONS**  
**Art Department Exhibit at Madonna College.** Detroit, through April 6 in the Activities Center. Works by students include oils, watercolors, drawings, sculpture, macramé, lapidary and jewelry, and projects in design. Open April 5 and 6 from 9-11 a.m., 14 and 7-9 p.m. Also, exhibit by graduating art students, in lower foyer of the administration building.

**Poetry Readings** by 14 selected students at 8 p.m. April 5 in upper level of the Newman House, located along Haggerty Road next to the south parking lot at Schoolcraft College, 18600 Haggerty Road between Six and Seven Mile in Livonia. Open to the public without charge.

**'Walk for Mankind'** Information Center open from 2-8 p.m. daily, from 11 a.m. to 8 p.m. Saturday and noon to 5 p.m. Sunday, booth in East Court of Westland Center. Westland Jaycees sponsoring annual marathon walk on May 15, with pledge proceeds to Project Concern, international health agency. Information Center open through May 2. **First Wednesday Fashion Show and Easter Bunny** at 10:30 a.m. April 7 in East Court. **Easter Bunny** sitting in spring barnyard setting to say hello to young children, April 7 through 17, during shopping hours. Instant color photos available.

**Exhibit of Student Work** at Schoolcraft College Northville, Cooke Center, through

April 23. Reception from 7-10 p.m. April 6. Work includes drawing, design, painting and printmaking. Hours 9 a.m. to 9 p.m. Monday through Thursday.

**International Coffee at Meadow Brook Hall** features pastry smorgasbord and informal tour. Bus leaves from Farmington Community Center at 9 a.m. April 8. Call the center at 477-8404 for further information.

**All About Roses** program with Forrest Geary sharing his knowledge of rose culture, especially as it applies to this area and climate. Geary is president of the Detroit Rose Society. Program begins with rolls and coffee at 9:30 a.m. April 9 at Farmington Community Center. Call center for details.

**Plymouth Community Arts and Crafts Show** and sale April 9, 19 and 11 in the Plymouth Cultural Center, 525 Farmer. Items made by 50 exhibitors will be available. The show opens at 11 a.m. each day and closes at 9 p.m. Friday and Saturday and 6 p.m. Sunday.

**Oakway Symphony Orchestra,** Francesco Di Blasi conducting, presents a Gershwin Spectacular collaborating with Dance Detroit. Ruth Burczyk, pianist, in Rhapsody in Blue and the Concerto in F. Staging by Jacob Lascu. Tickets priced for adults and for students and senior citizens, available at Hudson's.

**Paul Winter's Winter Consort** appears in concert at 8 p.m. April 11 at Church Hill High School Auditorium, 8900 Newburgh Road. Tickets at Student Activities office of Schoolcraft College, Livonia. Phone 591-6549 for information.

**Livonia Artists Club** holds 15th annual juried exhibition and sale April 11 from 1-7 p.m. in Carl Sandburg Library, 30100 Seven Mile, west of Middle Belt. Works by artist-members, also display of handmade pottery by John Groot and pottery by Regina Spriggs.

**SHOW TIME**  
 'Picnic' drama by William Inge at 8 p.m. April 7 through 10 in Quirk Auditorium on

Eastern Michigan University campus at Ypsilanti. Presented by EMU Players. Tickets on sale at box office. Call 487-1221 for information.

**The Harlem Globetrotters** perform at 2 and 7 p.m. April 11 in Olympia Stadium. Tickets available at Olympia, Grinnell's and Olympia Travel in Birmingham.

**Lorin Hollander** in concert at 8 p.m. April 2 in Corson Auditorium, Interlochen, as part of a piano mini-festival. Concerts and classes scheduled for April 19 and 20. Piano scholarship competition will take place during the festival.

**'Camino Real'** Tennessee Williams' expressionistic fantasy is final offering in University of Michigan's professional theater program. Performances at 8 p.m. April 7 through 10 and 3 p.m. April 11. Tickets available through Hudson's and the professional theater program office in the Michigan League Building.

**TALKING**  
**Antiques Lecture Series** at Henry Ford Museum in Dearborn presents discussion of Connecticut's Trumbull House by Elaine G. Stetson, director/curator of the Noah Webster Foundation and Historical Society of West Hartford, Conn., at 8:30 p.m. April 9 in Museum Theatre.

## Dining And Entertainment Guide ON THE TOWN

**SUBURBAN DETROIT THEATRES INC.**

**ABBEY 1 • 2 • 3**  
 14 Mile Rd. & I-75 588-0881

**FAIRLANE** LO 1-7200  
 Ford Rd. at Telegraph

**KINGSWOOD** 388-7111  
 Woodward at Square Lake

**NORTHLAND** 559-3366  
 J.L. Hudson Dr. - Northland

**OLD ORCHARD 1&2** 477-0010  
 Orchard Lk. Rd. N. of 12 Mile

**RADIO CITY** 543-5800  
 Woodward at 9 Mile

**TERRACE 1 & 2** GA 7-1200  
 30400 Plymouth, near Middlebelt

**TOWNE 1&2** 968-8700  
 Greenfield Rd. N. of 10 Mile

**VILLAGE** 643-8888  
 Maple (15 Mile) at Coolidge

**CALL THEATRES FOR FEATURES AND TIMES!**

EVERY **MONDAY** IS NOW **PUNDAY**

AT **Northville Charley's**

FOR THE WHOLE FAMILY

SEE **DEE DEE** THE CLOWN

make animals out of balloons.

- FREE BALLOONS •
- FREE CANDY •

Special Menu For Little People

EVERY MONDAY 5-10 P.M.  
 41122 W. Seven Mile Road

AMERICAN EXPRESS HONORED

**CANTONESE VILLAGE**

Exotic Cocktails

**COCONUT COOLER**  
 A smashingly refreshing drink, prepared artfully with rum and coconut milk—soft and smooth.

Just one of many drinks available.

- Lunches
- Dinners
- Snacks
- Carry-Outs

• Banquet Facilities Available

**EXQUISITE CANTONESE AND AMERICAN DISHES**  
 7107 N. Wayne Rd. and Warren  
 Across from Westland Center

729-1470 WESTLAND

**Hope's Fish & Chips**

Delicious Steaks, Frog Legs, Clams, and Scallops Diners

28370 JOY ROAD  
 IN SHOPPING PLAZA  
 Bet. Middlebelt & I-75

**TEN YEN** Restaurant

Under New Management (Open 7 Days)

CANTONESE, HONG KONG, MANDARIN, JAPANESE & AMERICAN FOODS

正宗粵菜 • 歡迎光臨

Special Businessmen's Luncheon  
 Over 120 Dinner Selections • Carry-Out • Special rates for big parties  
 PRIVATE BANQUET ROOM AVAILABLE

8997 WAYNE RD. at Ann Arbor Trail WAITRESS WANTED 425-8910

**SPRING ARTS & CRAFTS SHOW-SALE**  
 APRIL 9, 10, 11  
 FRI. & SAT. 11 a.m.-9 p.m. SUN. 11 a.m.-6 p.m.  
 at **PLYMOUTH CULTURAL CENTER**  
 525 FARMER • 455-6620  
 FREE ADMISSION • TABLE SPACE AVAILABLE

**ROMAN CHARIOT**

RESTAURANT & LOUNGE  
 Featuring Italian and American Dining

ENJOY -"DESTINY"  
 Thursday, Friday & Saturday

**FASHION SHOW EVERY WEDNESDAY & THURSDAY 12:30-1:30**  
**BUSINESSMEN'S LUNCHEON • BOUNTIFUL SALAD BAR**  
 Mon.-Tues.-Wed.-Thurs.

NEW YORK STRIP STEAK, Potato & Salad ..... \$4.95  
 VEAL PARMEGIANA, Side Order of Spaghetti & Salad ..... \$2.95  
 BAKED FISH, Served with Potato & Cole Slaw ..... \$3.95

**COCKTAIL HOURS: MON.-FRI. 3-6 P.M.**  
 Every Night **LOBSTER TAIL \$6.95**  
 Thurs.-LADIES' NIGHT  
 All Drinks For Our Lady Friends \$1

32828 FIVE MILE RD. - East of Farmington - 425-8530

**BONANZA**

Our Regular **TUESDAY NIGHT SPECIAL**  
 (4 p.m. 'til Closing)

- RIB EYE STEAK DINNER ..... 1.49
- CHOPPED BEEF DINNER ..... 1.39

BOTH INCLUDE POTATO, TEXAS TOAST & CRISP TOSSED SALAD

**AS ALWAYS**  
 FOR THE LIL' WRANGLER (Under 12)  
 HAMBURGER, FRIES & TOOTSIE POP ..... 59¢

AT THESE LOCATIONS ONLY

**SOUTHFIELD**  
 25610 W. 8 MILE RD.  
 AT BEECH DALY RD.  
 IN K-MART PLAZA

**LIVONIA**  
 33456 W. 7 MILE RD.  
 AT FARMINGTON RD.  
 IN K-MART PLAZA

**The Chalet** OF LIVONIA

COCKTAILS • LUNCHEONS • DINNER • BANQUET FACILITIES

**CHEF'S SUPER Specials!**  
 Served Mon. thru Thurs.  
**COMPLETE DINNER 4.95**

NEW YORK STEAK  
 TURKEY WITH DRESSING  
 STUFFED RAINBOW TROUT  
 FLORIDA RED SNAPPER

**DINNERS FROM 5.50**  
 Includes  
 HOT ROLLS, SALAD  
 FROM OUR BOUNTIFUL  
 SALAD BAR, SOUP  
 POTATO  
 HOMEMADE  
 DESSERTS  
 and  
 BEVERAGE

39305 PLYMOUTH ROAD, LIVONIA  
 One Mile West of Newburgh  
 FOR RESERVATIONS 464-2272

**1/3 LB. GROUND ROUND 90¢** SERVED ON SESAME BUN

**Red Bull** COCKTAILS 11-11

CALL NOW FOR **EASTER DAY RESERVATIONS**

SUNDAY LIQUOR

**LIVE LOBSTER DINNER ..... \$6.95**

CALL NOW FOR BOWLING BANQUETS  
 OFFICE PARTIES • FAMILY REUNIONS • SMALL BANQUETS

478-4380 OPEN SUNDAY 27725 W. 8 MILE  
 11 A.M. to 11 P.M. EVERY DAY (corner of Grand River)  
**RED BULL OF ANN ARBOR - U.S. 23 & WASHTENAW**

**You're invited to a Weekend Fling at the Plymouth Hilton Inn**

The Plymouth Hilton Inn proudly offers its "Weekend Fling." A mere \$45.00 plus tax per couple (Friday and Saturday night occupancy). The package includes:

- A luxurious room for two (or more—since children stay free if occupying the same room as their parents).
- Complimentary cocktail in either the Jolly Miller Lounge or The Park, our unique poolside coffee shop.
- Complete use of our indoor pool, whirlpool and sauna.
- Note—If you wish to extend your fling thru Sunday, you may do so for only an additional \$20.00 plus tax.

The Plymouth Hilton Inn  
 5-Mile & Northville Roads  
 Plymouth, Michigan 48170

For reservations call: **(313) 459-4500**

**BICENTENNIAL EDITION**

**This SUNDAY 1:30 PM**

**LONGHORN** WORLD CHAMPIONSHIP

**RODEO**

**World's BIGGEST One Day Rodeo!**

International Rodeo Association  
 Top 120 Cowboys - Cowgirls

FIRST TIME EVER, ANYWHERE  
 (in many of America and Canada's Top Cowboys and Cowgirls in ONE RODEO PERFORMANCE!)

**TICKET PRICES \$7.65, 5.4**  
 Kids 12 & Under 1/2 PRICE  
 For Ticket Information:  
 Call 313/857-8000

TICKETS AT: Pontiac Stadium, All Metro-Detroit Ward's & Hudson's Stores, including Toledo, Ann Arbor, Flint, Grand Rapids. Use Your Ward's & Hudson Charge Acct.

**PONTIAC STADIUM**

**GALA OPENING...**

A bouquet of fine wines, heavy cheeses and magical spices entices you into Vittorio's Inn The Alley and Vittorio's for exceptional dining.

Amidst the soft lights and roman decor, our staff will serve you at a pace which will compliment our heavenly pasta dishes or delicate sea foods. Please join us for a culinary experience you'll not soon forget.

Appearing at Inn The Alley, "The Ted Shealy Trio" Tuesday thru Saturday. Appearing at Vittorio's, "Celebration" Friday and Saturday.

**\$1.00 OFF All Italian Dinners** along with a complimentary glass of wine and a divine canoli. Daily 5 PM - Midnight. State sales tax and gratuities not included.

**VITTORIO'S INN THE ALLEY**  
 33201 Plymouth Road at Farmington Road Phone 536-8810. Please use our Alley Entrance Cocktail Hour 5-7

**Vittorio's OF LIVONIA**  
 33201 Plymouth Road at Farmington Road (in the Sheldon Center Plaza) Phone 425-8333

**CORSI'S**

RESTAURANT & COCKTAIL LOUNGE  
 Italian & American Cuisine

- BUSINESSMEN'S • FAMILY • BANQUET LUNCHEONS • DINING ROOM • ROOM

**LIVE ENTERTAINMENT**  
 FRIDAY-SATURDAY  
 with Tony Lee  
 Dancing • Floor Show  
 27910 WEST SEVEN MILE  
 West of Inkster KE 1-4960

American Youth Hostels Presents **JOHN BIDDLE**

**SAILING MOVIE**

Featuring:  
 Maine Coast Cruise, N.A. Jr. Sears Cup and St. Petersburg Isla Mujeres

**FRIDAY, APRIL 9**  
 8:30 p.m.  
**FORD AUDITORIUM**

Tickets \$3.50 Adults \$2.50 Youth  
 Available at Amer. Youth Hostels, 14335 W. McVickels Ford Aud. Wards & Hudson's



Monday, April 5, 1976

**312 Livonia**

**TODAY'S BUY TOMORROW'S SECURITY** 3 bedroom, 1 1/2 bath brick ranch, family room, full finished basement, living room, family room and 2 bedrooms carpeted. Large over 2 car garage is heated and has workshop \$43,900. Call 261-5080

Thompson-Brown Seclusion

is just one feature in this nice 2 bedroom home situated on a huge lot PLUS a huge family room. All for only \$22,900.

**Century 21** Boardwalk Div 459-3600

**FIRST TIME OFFERED!** 5 bedroom colonial in prime area of Livonia. 2 1/2 baths, formal dining room, family room with fireplace, 1st floor laundry. Carpeted throughout except 4 bedrooms. OWNER TRANSFERRED! \$56,500. Call 261-5080.

Thompson-Brown

**ASSUME NEXT WEEK** \$3800 Down. \$175 per month. 9% Interest. 2 Bedrooms, living room, kitchen, large utility room. All on a \$5,335 foot lot. \$16,200. 7 Mile, Mid-dlebelt area. Call after 4 PM. 835-8905

**312 Livonia**

**COUNTRY LIVING**  
Almost 1/2 acre, beautiful 2 story aluminum sided home, with 3 bedrooms, country sized kitchen, large utility room. Garage. Country setting, near all modern city conveniences. Only \$29,900. 525-7700

**Century 21**  
Gene Darke Realty

**ROSEDALE Gardens** charming Cape Cod, 3 bedroom, 1 1/2 baths, 2 fireplaces, family room, den, formal dining room, beautiful country kitchen, central air, electronic air cleaner, new wool carpet, real brick foyer. Inset secluded brick patio. \$46,900. 261-5456

**Over 3/4 Acre**

FOUR bedroom ranch features a harvest sized kitchen, first floor laundry and a full basement. Florida room and attached 2 1/2 car garage. \$39,900. Call 525-4200.

**Integrity**  
Realtors

BY Owner, attractive 3 bedroom Colonial, 1 1/2 baths, large country kitchen, family room with fireplace, enclosed patio, full basement, asking \$47,500. Buyers only. 464-3569

NICE 3 bedroom ranch, family room, built-ins, nicely decorated, finished basement, 2 1/2 car garage, patio. \$37,900. 494-2518

**312 Livonia**

OWNER 3 bedroom all brick ranch, 1 1/2 baths, family room with fireplace. Large kitchen, carpeting and drapes throughout, basement, central air. Attached garage. \$48,900. 523-8777

LIVONIA \$18,900 SPECIAL  
**2 BEDROOM DOLL HOUSE**  
PAVED STREET  
**CENTURY 21**  
CORNERSTONE 478-4660

**QUALITY QUAD**  
4 Bedroom, 2 baths, 21x15 Family Room with fireplace. Kitchen with all built-ins. Florida Room, attached 2 car garage. Immediate Occupancy. \$44,900.

**CENTURY 21**  
CORNERSTONE 478-4660

BY OWNER Beautifully landscaped spacious 3 bedroom brick ranch, 1 1/2 baths, family room with natural fireplace & built-in basement, 2 car attached garage, attractive court lot with large patio & pool \$44,900. 261-3115

LIVONIA \$32,900  
**COUNTRY LIVING**  
SHARP 3 bedroom bungalow, spacious kitchen with extras, full basement, large fenced tree lot.

**Red Carpet**  
REALTORS 522-3500

LIVONIA \$54,900  
**ONE ACRE**  
5 bedroom colonial, formal dining room, country kitchen, 3 full baths, rec room, in ground pool, cabana, many extras.

**Red Carpet**  
REALTORS 522-3500

**COUNTRY HOME**  
An all brick 3 spacious bedroom ranch with full basement, professionally finished, a gigantic living room with dining L. A completely remodeled modern kitchen, carpeting throughout, 1 1/2 baths and 2 1/2 car garage \$37,000. HARRY S.

**WOLFE**  
COMPANY  
23298 Five Mile GA 15660  
ONLY \$41,900  
**LIVONIA BEAUTY!**  
3 bedroom brick split-level, 2nd floor balcony off living room, 1 1/2 baths, huge kitchen, family room, attached 2 car garage.

**Red Carpet**  
REALTORS 522-3500

## CLASSIFICATION INDEX

**AUTOMOTIVE**  
850 Autos for Sale  
852 Antique Cars  
854 American Motors  
856 Buick  
858 Cadillac  
860 Chevrolet  
862 Chrysler  
864 Dodge  
866 Ford  
870 Jeep  
872 Lincoln  
874 Mercury  
876 Oldsmobile  
878 Plymouth  
880 Pontiac  
824 Sports & Imported Cars  
882 Thunderbird  
884 Volkswagen  
886 Auto Parts & Service  
818 Auto Rentals & Leasing  
819 Auto Financing  
820 Autos Wanted  
822 Trucks for Sale  
823 Vans  
800 Recreational Vehicles  
802 Snowmobiles  
804 Airplanes  
806 Boats & Motors  
808 Vehicle & Boat Storage  
810 Insurance Motor  
812 Motorcycles  
814 Mini Bikes  
814 Campers & Motorhomes

**EMPLOYMENT, INSTRUCTION**  
518 Education-Instruction  
500 Help Wanted  
510 Help Wanted Couples  
502 Help Wanted Dental-Medical  
507 Help Wanted-Part Time  
508 Help Wanted Domestic  
504 Help Wanted Office-Clerical  
506 Help Wanted Sales  
520 Secretarial-Business Services  
512 Situations Wanted Female  
514 Situations Wanted Male  
516 Situations Wanted Male & Female

**MERCHANDISE FOR SALE**  
702 Antiques  
706 Appliances  
700 Auction Sales  
712 Bicycles for Sale  
718 Building Materials  
714 Business & Office Equipment

**REAL ESTATE FOR RENT**  
400 Apartments to Rent  
422 Commercial-Industrial to Rent  
426 Houses to Rent  
428 Listings Wanted-Nursing Homes  
406 Duplexes to Rent  
410 Flats to Rent  
414 Florida Rentals  
402 Furnished Apartments to Rent  
402 Furnished Houses to Rent  
408 Garages to Rent  
424 Houses to Rent  
432 Living Quarters to Share  
418 Mobile Homes to Rent

**NOTICES & SERVICES**  
604 Announcements & Notices  
626 Bingo  
616 Hair for Rent  
618 Child Care  
614 Death Notices  
628 Entertainment  
616 Mail for Rent  
612 In Memoriam  
622 Income Tax & Insurance  
606 Legal Notices  
602 Lost & Found  
600 Personals  
624 Professional Services  
608 Transportation

**REAL ESTATE FOR SALE**  
311 Home for Sale  
311 Home for Sale  
302 Birmingham-Bloomfield  
351 Bus. & Professional Bldg. for Sale  
304 Farmington-West Bloomfield  
309 Northville-Nov  
308 Rochester-Troy  
306 Southfield-Livonia  
319 Homes for Sale  
Wayne County  
312 Livonia  
314 Plymouth-Canton  
318 Redford  
316 Westland-Garden City  
320 Other Suburban Homes for Sale  
Real Estate Service  
330 Apts for Sale  
360 Business Opportunities  
348 Cemetery Lots  
352 Commercial-Industrial  
322 Condominiums for Sale  
324 Co-ops for Sale  
324 Country Homes  
326 Duplexes for Sale  
350 Farms for Sale  
336 Florida Property for Sale  
354 Income Property for Sale  
356 Investment Property for Sale  
340 Lake & Resort Property for Sale  
342 Lakeland Homes for Sale  
354 Listings Wanted  
338 Lots & Acreage for Sale  
332 Mobile Homes for Sale  
338 Listings Wanted  
338 Lots & Acreage for Sale  
332 Mobile Homes for Sale  
358 Mortgages-Land Contracts  
346 Northern Property  
334 Out of Town Property  
368 Real Estate to Exchange  
362 Real Estate Wanted  
328 Townhouses for Sale

**312 Livonia**

HERE IS A HOME THAT IS DOMINATING WITH FINER FEATURES 4 bedrooms plus den or study and family room. Central air. Professionally finished basement. Pantry. 2 patios. Attached 3 car garage with overhead storage accessible by pull down ladder. Many other extras left for you to see \$69,900. Call 261-5080.

Thompson-Brown DELUXE

3 bedroom, beautifully decorated brick ranch, nice carpeting throughout, finished basement, 2 1/2 car garage. Close to schools, shopping and recreation area. Asking \$34,900. Call and ask for LILLIAN VERKERKE.

**Century 21**  
Boardwalk Div. 459-3600

**COLONIAL**, 4 bedroom, formal dining room, family room with fireplace, finished office in basement. Carpeted throughout, decorated and draped. Professionally landscaped. Fenced yard, 2 car attached garage. Brick, aluminum siding and trip. Appt. Only. Mon-Fri 9PM-10 PM. Anytime week ends \$46,500. 14233 Merriman. 522-5964

COULD YOU BELIEVE? Custom built "almost new" quad. Extras galore. 2 1/2 car side entrance garage, circular drive, central air, fantastic decor. Mammoth master bedroom. Located in a development of newer homes in an area of property appreciation. 7 1/4% assumption possible. Flexible occupancy. Only \$58,900. ML 9517.

**312 Livonia**

**FAMILY ROOM ROSEDALE GARDENS**  
Tremendous mortgage assumption of a 7% V.A. mortgage. 1ST OFFERING on this attractive 3 bedroom brick ranch with a spacious 20x15ft family room, large country kitchen with built-in dishwasher, full basement, 1 1/2 baths, 2 car garage and on an oversize 75 ft lot. Priced to sell at \$38,900. HARRY S.

**WOLFE**  
COMPANY  
23298 Five Mile GA 15660  
LIVONIA \$16,900  
**Livonia Bargain**  
DON'T Miss this sharp starter ranch. Large lot. Great Assumption.

**Red Carpet**  
REALTORS 522-3500

LIVONIA \$43,900  
**GREAT LOCATION**  
1600 Sq ft 3 bedroom brick ranch, country kitchen, 2 full baths, family room, fireplace, rec room, in ground pool, 2 car attached garage.

**Red Carpet**  
REALTORS 522-3500

THREE bedroom, 2 baths, family room with fireplace, finished basement. Wanderland area. Brick \$35,500. After \$ 422-0358

**312 Livonia**

**ROSEDALE GARDENS**  
It's the finest First offering - you won't believe a home can be so nice until you walk into this most gorgeous brick colonial located on one of the finest tree lined streets in Rosedale Gardens. A custom built home decorated to perfection, 3 king size bedrooms, formal dining room, kitchen built-ins, family room, full basement, complete with 2 car garage \$45,900. HARRY S.

**WOLFE**  
COMPANY  
23298 Five Mile GA 15660  
LIVONIA SCHOOL DISTRICT  
1/2 ACRE  
JUST REDUCED \$2,000  
Beautifully decorated 3 bedroom brick ranch, large living room with fireplace, lovely rec room with bar, oversized lot. Joy - New burgh area \$39,900.

**Red Carpet**  
REALTORS 522-3500

THREE bedroom, 2 baths, family room with fireplace, finished basement. Wanderland area. Brick \$35,500. After \$ 422-0358

JUST LISTED, small 2 bedroom cottage with furnishings plus an extra lot. \$29,900. EASY LAND CONTRACT TERMS. Toll free 1-800-552-0315.

BRIGHTON, Four year old 4 bedroom bi-level, 2 1/2 baths, 23x20 recreation family room combination with fireplace, fully carpeted, gas heat, fenced yard. A FINE HOME at \$39,900. Toll free 1-800-552-0315.

YOU CAN'T BE PRESIDENT but you can be KING of this large "new" 3 bedroom Colonial. It features a formal dining room, family room with fireplace, 2 1/2 baths, full carpeting, 2 1/2 car garage plus 240x198 peaceful setting. \$61,900. Hartland Schools. Toll free 1-800-552-0315.

BREATHTAKING VIEW of beautiful White Lake from large 3 bedroom home, cozy family room with fireplace, 27' of doorways facing the lake. Definitely not a drive by. \$43,900.

WALKING DISTANCE TO SCHOOL, sharp 3 bedroom ranch, 11x11 dining area, 13x11 master bedroom, full basement, attached garage, large fenced lot and excellent Union Lake privileges. \$33,900. 363-7117.

JUST LISTED, 5 bedroom all brick farmhouse on 2.4 acres in area of new homes. 80% remodeled in 1975. This country home has over 1800 sq ft of living area. Needs handyman to complete. \$44,900. Hartland Schools. Toll free 1-800-552-0315.

**ENGLAND**  
REAL ESTATE  
1-363-7117 632-7427  
3063 Union Lake Road 12316 Highland Road  
Union Lake Hartland  
REALTORS

**Red Carpet**  
REALTORS 522-3500

**WOLFE**  
COMPANY  
23298 Five Mile GA 15660  
ONLY \$41,900  
**LIVONIA BEAUTY!**  
3 bedroom brick split-level, 2nd floor balcony off living room, 1 1/2 baths, huge kitchen, family room, attached 2 car garage.

**Red Carpet**  
REALTORS 522-3500

We reserve the right to classify, revise or reject any want ad. Want ads may be placed until 4 p.m. Tuesday for the Thursday edition and 4 p.m. Friday for the Monday edition. No cancellations accepted after noon Tuesday for Thursday editions or noon Friday for Monday editions. No cancellations before first insertion. No cancellations on Double Action Ads. The Observer & Eccentric Newspapers will not issue credit for errors in ads after the first incorrect insertion. Report any errors immediately. Phone Room hours are 8:30 a.m. to 5:30 p.m. Monday through Friday.

CALL CLASSIFIED DIRECT  
**644-1070** OAKLAND COUNTY  
**852-3222** ROCHESTER AVON TWP.  
**522-0900** WAYNE COUNTY

Now you can charge your classified ad to your Bank Americard or Master Charge account. Please have your card handy whenever you call.

**Century 21**  
VINCENT N. LEE  
EXECUTIVE TRANSFER SALES  
478-5900

LIVONIA 1/2 ACRE  
**Only \$24,900**  
Spacious 5 room brick ranch with garage on lovely 102x133 fenced lot. GOOD AREA.

**Red Carpet**  
REALTORS 522-3500

W CHICAGO Near Inkster. Immaculate 1 bedroom, garage, 1 1/2 acre. Asking \$20,000. Call after 6 PM. 561-9305

**COUNTRY HOME**  
Delightful 3 bedroom brick ranch, 2 car garage, 1 1/2 baths, full basement. Asking \$49,900. Call DON KAMEN.

One Way 522-6000

**WE MAKE IT HAPPEN**

**COMPACT**  
Price, payments and this 2 bedroom home on large lot, almost 1/2 acre. Big 24x24' garage. \$7,000 takes over low payments of \$138. Asking \$19,900.

**CUSTOM QUALITY**  
Garden City presents this attractive 3 bedroom brick ranch, 2 1/2 baths, large fieldstone fireplace, finished recreation room, attached 2 car garage. Wet plaster, marble sills and hardwood floors. Wide landscaped lot. Asking \$52,900.

**THINKING OF SELLING?**  
We have buyers. Call us first.

**Weldon Clark**  
REALTORS  
27492 Five Mile Livonia 425-7300

**WESTLAND**  
A Home & Gardens House! Immaculate - Professional decorating and beautifully done. Country kitchen with dishwasher, shag and deep pile carpeting. What a bathroom! Magnificent wallpapering. Natural fireplace, new 2 1/2 car garage. \$37,900. Call 326-2000

**NORTHVILLE**  
Courtly Colonial. Beautiful double-wing Colonial with library, 2 1/2 baths, plush carpeting, 2 car attached garage. Nicely landscaped, huge lot. Prestigious subdivision - Lexington Commons \$74,500. Call 455-7000 (38107)

**PLYMOUTH**  
New executive type 2 and 3 bedroom, 2 and 2 1/2 bath condos under construction. Completion approximately April 1976 in beautiful Woodgate community located near historic Plymouth. All modern conveniences, natural fireplace, full basement, garage. Club house, pool. Prices range from \$40,500 to \$49,990. Models open every Saturday 1:00 to 4:00 and Sunday 2:00 to 5:00. Call 455-7000.

**LIVONIA**  
Small Estate - Sharp 3 bedroom brick ranch with full basement, forced air gas heat, natural fireplace in family room. Large 70x179 lot. Ideal for garden lover. Seller transferred! \$36,900. Call 261-2600 (37869)

**LIVONIA**  
Super sharp 3 bedroom brick ranch with new country kitchen, central air, finished basement with 1/2 bath and wet bar. \$28,900. Call 477-1111 (36506)

**DEARBORN**  
Three bedroom custom ranch. Close to schools, churches and shopping. \$35,500. Call 274-9510 (37117)

**1776-1976**

**HOME OWNERSHIP: AN AMERICAN TRADITION**

ANDREW JACKSON - The Hermitage, Tennessee  
"I want to accumulate land, miles and miles of land, great herds of cattle and horses, and raise fine crops for market. I want us to be secure."

THEODORE ROOSEVELT - Sagamore Hill, New York  
"Every person who invests in well selected real estate in a growing community adopts the surest and safest method of being independent. For Real Estate is the basis of wealth."

GEORGE WASHINGTON - Mt. Vernon, Virginia  
"Strongly I am impressed with beneficial effects which our country would receive if every citizen owned his own home."

**DEARBORN HEIGHTS**. Better take a look at this one! Nice 3 bedroom ranch in quiet suburban setting. Convenient to most everything! Bring all offers. \$28,900. Call 274-9510 (36797)

**LIVONIA**. Country like atmosphere with fruit, hardwood, and pine trees. Nice surroundings for this 1 1/2 story aluminum home with formal dining room, basement, 2 car garage \$29,900. Call 261-0700.

Exciting 4 bedroom, 5 year old ranch shows like a model! Picture perfect. Carpeted throughout except in the super kitchen which has Solstice flooring. 1 1/2 baths, 2 1/2 car garage. Desirable assumption. Great buy! \$29,900. Call 477-1111 (36759)

**GENOA TOWNSHIP**. Ideal home site approximately 7 miles from I-96, convenient to downtown Brighton near Burroughs Farms. Horses allowed! Park test will be provided. 11.34 acres. \$22,000. Call 261-2600 (70811)

**GARDEN CITY**. Nicely decorated and remodeled 2 story aluminum home. Set back from the road and framed in with trees. Gas fireplace, heated garage. An additional lot with pool is available on land contract terms. \$29,900. Call 326-2000 (37697)

**WESTLAND**. Well kept duplex on Cherry Hill. Each side has living room, kitchen, dinette, 2 bedrooms, bath, stove and refrigerator. Fenced yard, 2 car garage. Live in one and rent the other! Good opportunity! \$47,800. Call 455-7000 (80433)

**Real Estate One.**

**REALTOR**

**REAL ESTATE OPPORTUNITIES**

**LIVONIA**  
Excellent location - 4 bedroom, all brick, no maintenance home. Carpeting one year old, double closets, hardwood floors, phone jacks. Lovely finished recreation room. Shopping and schools within walking distance. Bring all offers! \$37,900. Call 261-2600 (37836)

**LIVONIA**  
Excellent assumption on this 4 bedroom Colonial located in beautiful Idle Hills Estates. This home has 2 1/2 baths with full bath off master suite, formal dining, 1st floor laundry room, cozy fireplace in 23 ft long family room, large 2 car attached garage. \$62,900. Call 261-0700 (36815)

**LIVONIA**  
Desirable area - schools, shopping, and transportation within walking distance. Extra insulation, air conditioned living room, carport like new. Phone jacks in home plus poolside heated pool with new filter and equipment included. Assumption terms. \$34,900. Call 261-2600 (37264)

**CANTON**  
Country living in this 3 bedroom ranch with 2 full baths, family room with beamed cathedral ceiling and fireplace, attached garage, full part finished basement. Nicely landscaped lot. \$44,900. Call 261-0700 (37674)

312 Livonia FOR YOUNG MODERNS Featuring a spacious open floor plan, this 2 or 3 bedroom brick ranch home has all aluminum trim, a huge kitchen with built ins, large patio, full finished basement with a half bath, and a 2 car garage. An outstanding value at \$38,500. HARRY S.

312 Livonia \$39,900. Immediate occupancy. 1833 Myron. 3 bedrooms, 1 1/2 baths, family room, full basement. 7 Mile - Farmington. Owner. 478-2578

312 Livonia GET A GOOD START ON LIFE Buy your first home in Livonia. This cute 3 bedroom ranch sits on a large lot with a garden. It's been newly decorated and has 1 1/2 baths. Asking \$27,900. Can be assumed. Call: DON KAMEN. One Way 522-6000

312 Livonia FIRST OFFERING Don't miss this extra ordinary buy. It's an all brick tri level with a modern kitchen with built-ins, a huge living room with door wall to a beautiful covered patio, 3 nice sized bedrooms, 1 1/2 baths, a large family room and an attached garage. While it lasts \$38,900. HARRY S.

314 Plymouth Canton ATTRACTIVE 3 bedroom brick ranch on tree lot in City of Plymouth, 2 1/2 car garage, finished basement, under \$46,000. 455-7153

314 Plymouth Canton RARE FIND One of a kind custom 3 bedroom brick ranch in Salem Township with Plymouth Schools. Move-in condition describes the care given this beautiful home with a huge country kitchen and family room combination. 2 full baths, full basement, and a 2 car attached garage on over an acre. Asking \$52,900. HARRY S.

314 Plymouth Canton MASTER BATH In this almost new brick ranch with 3 bedrooms, full basement, 2 car attached garage, all built-ins included, in a nice area of Plymouth. Asking \$39,900. Hurry! Ask for DON KAMEN. One Way 522-6000

316 Westland Garden City WESTLAND 3 bedroom brick basement, \$3,000 assumes. \$36,900. \$287 monthly. Ross Realty. 326-8300

316 Westland Garden City ROOM TO ROOM On this Super Large Lot, almost new brick ranch home with 3 large bedrooms, kitchen, full basement. Very low assumption. Just reduced \$23,700. 525-7700

WOLFE COMPANY 33235 Seven Mile 427-0733 PRICE \$29,900 Don't miss this most attractive 3 bedroom, all brick ranch in an excellent area a modern kitchen with pantries, 1 1/2 baths, a full finished basement, an enclosed terrace and garage. All this on a nicely landscaped yard with trees. HARRY S.

Century 21 HARTFORD S. 261-4200 1st OFFERING You won't find a better buy than this 3 bedroom face brick ranch. Full basement, 2 full baths, family room with fireplace, huge country style kitchen, like new carpeting throughout. Quick occupancy and terrific assumption. \$36,900.

WOLFE COMPANY 32398 Five Mile GA 1-5660 DUTCH COLONIAL A home of perfection, this all brick colonial has an all polished brick foyer with a step up to a sharp living room, also leads to a formal dining room and a mother's dream kitchen with built-ins. Overlooking the most beautiful family room with an unbelievable brick wall fireplace, a full basement and attached garage. All this plus central air conditioning and a nice size lot. \$57,500. HARRY S.

WOLFE COMPANY 32398 Five Mile GA 1-5660 MINI FARM Situated on over a half acre is this sharp and clean 2 bedroom ranch home with a separate dining room, large modern kitchen and a 2 car garage. Truly a beautiful home for retirees or the first home buyer. Asking \$27,900. HARRY S.

WOLFE COMPANY 32325 Seven Mile 427-0733 ROSEDALE TRI \$11,700 assumes a 7% mortgage on this lovely 3 bedroom brick tri-level. 1 1/2 baths, family room fireplace, formal dining room and 2 1/2 car garage. Home in move-in condition at \$37,900.

WOLFE COMPANY 32398 Five Mile GA 1-5660 SUPER SHARP and beautifully decorated 4 bedroom colonial. 1 1/2 baths, living room, formal dining room, huge country kitchen, family room with fireplace, extra large basement, plush carpeting, custom draperies, patio, gorgeous fieldstone front on the house, extra large park lot, many extras. For appointment to see. 459-1924

WOLFE COMPANY 32398 Five Mile GA 1-5660 WINDSOR PARK RANCH 3 bedrooms, family room with fireplace, full basement, 1 1/2 baths, 6 ft. privacy fence, 2 patios on a quiet court. Attached garage. \$48,900. After 6 PM 455-4180

Century 21 HARTFORD S. 261-4200 THREE BEDROOM, attached garage, double lot fenced, air conditioned, near shopping and schools. See to appreciate. 15208 Melrose, Livonia. \$35,900. By owner. 425-7892

Century 21 HARTFORD S. 261-4200 BY OWNER Livonia 3 bedroom brick ranch, 1 1/2 baths, finished basement, carpeted thru-out, 2 1/2 car garage with electric opener. \$36,900. 522-1853

WOLFE COMPANY 32398 Five Mile GA 1-5660

Century 21 HARTFORD N. 261-2000

WOLFE COMPANY 32398 Five Mile GA 1-5660

WOLFE COMPANY 32325 Seven Mile 427-0733

WOLFE COMPANY 32398 Five Mile GA 1-5660

Century 21 Hartford West, Inc. 453-7600

Century 21 Boardwalk Div. 459-3600

Century 21 Boardwalk Div. 459-3600

Century 21 Boardwalk Div. 459-3600

George SMITH Realty Inc. of PLYMOUTH-CANTON Peg Shay Realtor-Associate CALL 453-4840 PLYMOUTH-CANTON 702 S Main in Plymouth

EARL KEIM REALTY from the HELPFUL PEOPLE! RANCH—sharp all brick, 3 bedrooms, carpet throughout, finished basement with bar. 2 air units, garage, fenced lot, convenient location. PRICE \$35,900 CALL 261-1600

Century 21 HARTFORD S. 261-4200 REMARKABLE RANCH Super sharp and with all the work saving features a fun loving family could want. Starting with a maintenance free exterior, first floor laundry, excellent traffic pattern, huge kitchen with dishwasher, beautiful carpeting throughout, family room, 1 1/2 baths, full basement and a 2 car attached garage. All on a country sized fenced yard for only \$44,900. HARRY S.

Century 21 HARTFORD S. 261-4200 FARMINGTON Valley view condo. Close to town overlooking a park like setting in a prestigious adult community. Very plush 2 bedroom, 2 full baths, central air. Has storage area plus utility room. For appointment call John Kare 477-6300 or 348-9664 (G 63).

Century 21 HARTFORD S. 261-4200 CITY - HOUGH PARK AREA Custom home by owner, 4 bedrooms, 2 tiled baths, separate dining room, large family room with fireplace, walk out master bedroom, private yard, trees, 2 car garage with enclosed porch, gas heat. BUYERS ONLY. \$67,500. 453-2400

Century 21 HARTFORD S. 261-4200 FUSSY BUYERS Sharp 3 bedroom brick ranch family room fireplace, finished rec room, a kitchen built specially for Mom with loads of cupboards. 2 1/2 car garage, patio and gas grill. Asking \$41,900.

Century 21 HARTFORD S. 261-4200 'O' DOWN Lot of House on a large lot, with 3 bedrooms, family room, 1 1/2 baths, attached 2 1/2 car garage. \$21,500. Call 522-8500

Century 21 Boardwalk Div. 459-3600 WESTLAND 3 bedroom brick ranch, fully carpeted, finished basement with large bar, 18 ft. swimming pool, excellent area of Wayne. Immediate possession \$27,500. With only \$1,500 down on contract if your credit is good. 728-6513

Century 21 Boardwalk Div. 459-3600 WESTLAND 3 bedroom brick ranch, fully carpeted, finished basement with large bar, 18 ft. swimming pool, excellent area of Wayne. Immediate possession \$27,500. With only \$1,500 down on contract if your credit is good. 728-6513

EARL KEIM of Dearborn, Inc. LIVONIA OFFICE 15707 FARMINGTON RD., LIVONIA 261-1600

WOLFE COMPANY 32325 Seven Mile 427-0733 ALSO A SELECTION OF RESIDENTIAL AND COMMERCIAL BUILDING SITES AND ACREAGE PARCELS.

Robert Bake-Realtor PLYMOUTH'S well known BEACON HILL PRESENTS AN ORIGINAL OWNER FARM COLONIAL with a long list of features. 4 bedrooms, 2 1/2 baths, handsome fireplaces in both the MASTER BEDROOM and FAMILY ROOMS. Special detailing in the Formal Dining Room. 1st floor laundry, full basement, and 3 1/2 car end entrance garage. CENTRAL AIR too. An easily assumable mortgage. PERFECTLY DECORATED. \$89,900. 453-8200

Red Carpet REALTORS 522-3500 WESTLAND 3 bedroom brick ranch, fully carpeted, finished basement with large bar, 18 ft. swimming pool, excellent area of Wayne. Immediate possession \$27,500. With only \$1,500 down on contract if your credit is good. 728-6513

Buy The HOME You Want NOW... And Let CHAMBERLAIN Sell Your Home The "GUARANTEED WAY"! Chamberlain REALTORS

1005 W. Ann Arbor Trail Plymouth 453-8200 COMPLETELY CAPABLE OF CATERING most successfully to the Active Family. A Premium Plymouth location with over 250 feet of frontage, its setting is beautifully developed and enhanced by a Circular Drive. Central Air. A pleasing entrance hall with a curving stairway. AN INVITING STUDY plus all the expected rooms. The Master Bedroom suite gives one plenty to favorably comment upon. SUPERB CONDITION THROUGHOUT. 453-8200

ROCHESTER \$53,565 IMMEDIATE OCCUPANCY Builder's former model. Beautifully decorated two story Colonial home with approximately 1,860 sq. ft. of living and bonus space. 3 bedrooms, 1 1/2 baths, Rochester Schools. Call Mike Lawrence at 652-4550 and ask about Lot #146. PULTE Homes of Michigan, Inc.

**316 Westland Garden City**  
**SHARP**  
 family room complete with wet bar, 3 full baths, 3 bedroom brick ranch completely carpeted with 1500 sq. ft. of living area and 2 1/2 car garage for only \$34,900 in Garden City.

**Century 21**  
 Boardwalk Div. 459-3600

**COUNTRY**  
 sitting right in the city. All brick ranch with FOUR bedrooms, 2 full baths, natural fireplace in the living room, family room PLUS game room. Asking only \$54,900 on a huge lot.

**Century 21**  
 Boardwalk Div. 459-3600

**IMMACULATE** well kept 3 bedroom brick ranch, gorgeous wood floor, central air conditioning, carpeted throughout. Beautiful finished basement with brick fireplace, gas logs, 2 1/2 car aluminum garage. Great \$33,900. Owner. 622-1380

**FHA or VA**  
 financing is available on this 3 bedroom colonial with a full finished basement and an attached 1 1/2 car garage for only \$28,900.

**Century 21**  
 Boardwalk Div. 459-3600

**Original Owners**  
 are selling their immaculate 3 bedroom brick ranch that is beautifully decorated, has finished basement and bar, patio and gas barbecue for only \$29,900

**Castelli**  
 525-7900

**WESTLAND**, by owner 3 bedroom, large kitchen, basement, carpeting, 2 1/2 car garage, attached patio, deal location, fenced lot. \$24,900. 721-3383

**JUST LISTED**  
 Super sharp 3 bedroom brick ranch, sharp kitchen with door wall to patio, new plush carpeting throughout, beautiful rec room and bar. 2 car garage. \$31,900

**Castelli**  
 525-7900

**WE FOUND ONE!**  
 Yes, we found a 4 bedroom quad-level on 1/4 acre in the country. New! Yes, almost! With family room, rec room, central air and more. Asking \$45,900. Call DON KAMEN

**One Way** 522-6000

**318 Redford**

**BARGAIN**  
 Priced 4 bedroom home will provide you with many years of happiness, bright modern and cheerful kitchen, large fenced lot and complete with a 2 1/2 car garage. \$21,500. Call 525-4200

**Integrity**

**CUSTOM RANCH**  
 BEAUTIFUL 3 bedroom brick, spacious kitchen, 1 1/2 baths, rec room, plus Florida room, 2 1/2 car garage. Lots of extras

**Red Carpet**  
 REALTORS 522-3500

**REDFORD**  
 Only \$25,500

**Red Carpet**  
 REALTORS 522-3500

**SO REDFORD**  
 BY OWNER Three year old brick ranch, 3 bedrooms, family room with fireplace, 24 x 24 garage. Central air, fire alarm. \$41,900. 337-6894

**GOING, GOING, GONE!** Don't delay in seeing this sharp, ready to move into, 3 bedroom, 1 1/2 story home! Fully remodeled, includes full basement and 2 car garage. LOW, 1 year LAND CONTRACT terms! Only \$22,800.

**ELLIS** 476-1700

**REDFORD TWP.**  
 Dixie-corner Graham, attractive ranch on large wooded lot, 2 large bedrooms, and den, family room, utility room, gas heat, double car port, only \$28,900

**TOWER** 478-5090

**302 Birmingham Bloomfield**

**BY OWNER** Bates, 1 1/2 story, 3 bedroom, full basement, large screened porch, mature trees, recently decorated. \$38,900. 646-2138

**BY OWNER** Birmingham. Convent in-town colonial 4 bedrooms, 2 1/2 baths, family room, many extras. \$54,900. 642-8143

**SIX MONTH** old Owner transferred 3 bedroom southern colonial in family room, library, custom built with many extras. Approx. 4000 sq ft. 3 car attached garage. Lahser, Quanton area. \$165,000. 646-2911

**BIRMINGHAM** 1 1/2 story. Living room with fireplace, dining room, 4 bedrooms, 2 1/2 baths, finished basement, garage, fenced yard. Pembroke School, near community. \$43,500. 642-8216

**BEAUTIFUL DECOR** with expensive carpeting throughout. Nicely groomed Colonial in town Birmingham - walk to shopping, schools, commuted. Remodeled kitchen, snack bar, separate dining room, big windowed family room, fireplace, rec room, 3 bedrooms, 1 1/2 baths, 2 1/2 car. Patio 1 1/2 baths, BBQ in fenced yard. \$55,900.

**ASK FOR DENNIS WOLF**  
**chamberlain**  
 6 4 7 - 5 9 5 0

**LONE PINE-FRANKLIN** area. Bloomfield Hills Schools. Spacious 4 bedroom quad with large family room and library. Remodeled kitchen, central air conditioning. Many other extras. \$89,900.

**BIRMINGHAM** 3 bedroom ranch with air conditioning, attic fan, and 40 x 20 ft. enclosed heated pool. Midvale - Enclosure, Seaborn schools. Immediate occupancy. \$89,900. 643-0447

**BIRMINGHAM** West. Lincoln 3 bedroom brick Cape Cod. \$29,900. 682-2722

**302 Birmingham Bloomfield**  
**BLOOMFIELD HILLS**, brick ranch on landscaped half acre in scenic area, 3 large bedrooms with huge illuminated walk-in closets, 2 1/2 baths, electric fireplace, crown molding, draped, intercom, 12 x 26 Florida room, covered patio, living room with raised hearth, family room - parquet floor, fireplace, excellent floor plan, new gas furnace, central air, 2 1/2 car attached garage, beautifully landscaped. Premium lot. Must see! \$87,000. 652-6088

**BY OWNER** - 5 bedrooms, 2 1/2 baths, near St. Regis June occupancy. 7 1/4 mortgage. Inground heated pool, in 80's. Call from 10 to 4 PM weekdays. 658-0086

**LAKE** frontage, 160 ft., 2 1/2 acres. Bloomfield Hills schools, upper level - 3 bedrooms, 2 1/2 baths, 16x36 living - dining room, 40 ft. window wall, cathedral ceilings, 3 - way fireplace, slate floor, breakfast room & foyer, kitchen, laundry room, pantry, 2 1/2 car garage, beautiful 12x14 family room, bath. \$180,000. 334-9040

**BEVERLY HILLS OF ROYAL OAK**  
 BY OWNER - Immaculate cathedral ceiling Ranch. 3 good sized bedrooms, spacious living room with new carpeting, quarry slate entrance hallway. Fabulous family kitchen, 30' by 13' with built-in oven, range, dishwasher, disposal. Double sink main bath, master bedroom enclosure and 2nd bath off kitchen. Lower level family room with decorative fireplace, game room with dry bar, storage room, laundry room, walk-in playroom. Gas heat, air conditioning, air filter, carpeting and wallpaper throughout. Redwood carpet with large storage cabinet. Beautifully landscaped for easy maintenance. Prime location. \$43,900. 549-4026

**BLOOMFIELD** Orchards, 822 Ashburnham, all brick 3 bedroom 1 1/2 bath ranch, attached garage, basement, fenced yard, large lot. 3 bedrooms. Assumable mortgage or rent with option to buy. Mr. Stevens. MI 4-225

**CHARMING** 1 1/2 story in desirable Pembroke area. 3 bedrooms, eat-in kitchen, rec room, screened porch, 2 1/2 car garage, fenced lot. Excellent condition. By owner. \$41,500. 646-5270

**BIRMINGHAM**, all brick 1 1/2 story, new roof, furnace, aluminum trim storms and screens, garage appliances included. Redone inside and out. Beautiful trees. Walk to Pierce School. \$34,900. 647-4254

**CUSTOM CHALET** COLONIAL, 4 bedroom, library, 4 full and 2 half baths, finished recreation room, fireplaces in living room and family room, oversized garage, central air, automatic lawn sprinkler, professionally landscaped. Bloomfield Hills location. \$153,000. Owner. 646-5140

**KNOLLWOOD CIRCLE**  
 Immaculate condition. 5 bedrooms, 6 baths. Tri-level plus basement. 1 1/2 acre wooded lot. Birmingham Schools. Sewer, water. Custom marble features. Private study in master bedroom suite with His & Her baths. Huge family room with conversation pit and many built-ins. \$156,000. 626-4121

**QUARTON** Lake Estate - Cape Cod, 4 bedrooms, library, 3 full baths, central air, full basement with carpeting, beautiful trees and yard. \$76,900. Buyers only. 645-1768

**1479 WASHINGTON**  
 ATTRACTIVE 1 1/2 story brick bungalow in popular Birmingham neighborhood. 3 bedrooms, 1 1/2 car garage, new roof, patio, kitchen appliances included. \$49,900. 647-4088

**BLOOMFIELD HILLS** Immediate occupancy, 4 large bedrooms, master bedroom has walk-in closet, dressing room, 2 1/2 baths, large paneled family room with fireplace. Formal dining room. 1st floor laundry, paneled and carpeted basement. Walk to St. Hugo's & public schools. Built-in Gunite swimming pool on extra large lot. \$73,900. Call after 5pm. 332-6764

**BIRMINGHAM** 3 bedroom ranch, 2 1/2 car garage, rec room, 2 baths, eating area in kitchen, living room with dining end, close to schools, Bowers \$38,500. Open Sunday 3:30-7 PM. 642-4425

**304 Farmington West Bloomfield**  
**FARMINGTON HILLS** By Owner, 4 bedroom, 2 1/2 bath Quad-Level on a beautiful tree lot. Many features include: maintenance free exterior, built-in family room with fireplace, finished lower recreation room, plus much more. \$68,500. Assumable 7 1/4 mortgage. 851-4912

**FARMINGTON HILLS** beautiful landscaping, 4 bedrooms, 2 1/2 baths, central air, other good features. 478-2543

**LARGE COUNTRY HOME** on 1/4 acre overlooking Birmingham Hills Golf Course. 4 bedrooms and extra large living room with marble fireplace, formal dining room, walk-in closet, family room. Asking \$74,500. Call 476-8700.

**FARMINGTON HILLS** beautiful landscaping, 4 bedrooms, 2 1/2 baths, central air, other good features. 478-2543

**FRANKLIN VALLEY SUB** elegant tri-level, 3 bedrooms, and den or 4th bedroom, gorgeous landscaping, 2 1/2 baths, \$75,900. 626-7940

**FARMINGTON HILLS** by owner. Exquisite modern quad level. Balcony in dining room overlooks dramatic sunken living room with 26 ft. ceiling and see-through fireplace to family room. Master bedroom has fireplace, full bath, balcony overlooking living room and sliding glass door wall to wood deck. 4 bedrooms, oversized kitchen, 1st floor library, basement, 3 car garage. Premium lot. Must see! \$87,900. 478-4847

**FARMINGTON HILLS**, Lincolnshire Sub. 25762 Castlereigh 3 bedroom ranch, 2 1/2 baths, first floor laundry, large family room, fireplace, electric carpeted, \$73,900. 478-4798

**TENNIS PLAYERS** W. Bloomfield colonial with regulation tennis court in back yard, 4 bedrooms, 2 1/2 bath large kitchen with built-ins, family room with natural fireplace, central air, and maintenance free pool. \$79,900. OPEN SUN 12-4 PM. 315-4450. 626-0022

**FRANKLIN TOWN**, 4 bedroom, 2 1/2 baths, colonial with fireplace in family room, den, air conditioning attached garage. Immediate occupancy. \$85,000. Land Contract Available. By owner. 354-2910. 626-2816

**OLDE FRANKLIN TOWN**, 4 bedroom, 2 1/2 baths, colonial with fireplace in family room, den, air conditioning attached garage. Immediate occupancy. \$85,000. Land Contract Available. By owner. 354-2910. 626-2816

**KENDALWOOD**  
 It's a dandy. Call now on this 3 bedroom brick with family room, full tiled basement, attached 2 car garage, beautiful landscaped lot. Excellent location for schools, shopping and expressway. \$49,900

**FARMINGTON HILLS**  
 Only \$33,900 for this 3 bedroom tri-level with family room, 1 1/2 baths, deep lot. Excellent assumption.

**JUST REDUCED**  
 For quick sale - owner transferred. Tri-level with 2 1/2 baths, 3 bedrooms, family room, 1700 sq. ft. of living area. \$37,900

**Sanderson REAL ESTATE**  
 UNITED 535-2720 474-3008

**304 Farmington West Bloomfield**  
**OUTSTANDING BRICK RANCH** on super treed acre and half in downtown area of Farmington. Large 3 bedroom, 2 1/2 bath home with massive family room with fireplace, living room with fireplace, separate dining room. Gorgeous kitchen, new Florida room and tasteful decor. Quality throughout. This gem will not last! Call now for details and tour. \$79,900. Call 478-8700.

**Thompson-Brown LOVELY COUNTRY SETTING**  
 Three bedroom ranch on nearly one acre, features beamed ceiling in living room plus formal dining room. Won't last at \$36,900. Call 525-4200.

**LOVELY LARGE BEDROOM** 1 1/2 bath colonial. Large eat in kitchen, living room, paneled family room with wood burning fireplace, full basement, car attached garage, air conditioner and purifier, excellent carpeting throughout, fenced-in back yard, desirable young neighborhood with walking distance to school and shopping. \$44,500. 558-6008

**Lathrup Village**  
 Custom built brick ranch approximately 1/2 acre, 2 bedrooms, family room with fireplace, 2 1/2 baths, full basement, many extras. Immediate possession. \$61,900.

**Thompson-Brown Birmingham-Bloomfield** 642-0703

**MUST SELL**, Inkster and Shawneet, 1 year old 3 bedroom ranch on slab, brick front, aluminum siding, carpeted, newly decorated, 10 x 10 utility room, 2 car garage, \$218 monthly. 7 1/4 mortgage. Anxious. Make an offer. 358-0296

**SOUTHFIELD \$53,500 PILLARED COLONIAL**  
 FANTASTIC 4 bedrooms, formal dining room, family room, fireplace, patio, rec room, 3 car attached garage, central air, large lot. Immediate occupancy.

**WEST BLOOMFIELD** 4 bedroom, 2 1/2 bath colonial, in Old Farm Subdivision. Living room, dining room, beamed family room with fireplace, drive in large trees with central air, walk to schools and subdivision pool. Extras \$72,500. 851-4258

**SOUTHFIELD \$53,500 PILLARED COLONIAL**  
 Sharp 3 bedroom ranch with a fireplace. Big country kitchen, 2 car garage, Nearly 1/2 acre lot with trees. \$47,900. Weaver Real Estate 1340 Walton Blvd. Rochester 651-8140

**ROCHESTER, BY OWNER**, Wemberston. 1 year old 3 bedroom family room with fireplace, 2 1/2 baths, family room with fireplace, 2 1/2 car attached garage. Landscaped lot. 375-4229

**TROY** quad, by owner, 3 bedrooms, beamed family room, den or 4th bedroom, 2 1/2 baths, living room, full length fireplace with electric eye opener. In an established neighborhood near schools and freeways with many extras such as an in-ground, heated swimming pool. OPEN SUN 2-5 PM. 524-9674

**BY OWNER** - 4 bedroom, 2 1/2 bath colonial, air conditioned, paneled family room with fireplace, 1st floor laundry, intercom, finished basement, gas BBQ, attached rec room, garage with opener, fully decorated, mint condition. \$57,500. 558-2023

**WEST BLOOMFIELD \$52,990 NOW BEING BUILT**  
 California contemporary 2 story, 3 bedrooms, 2 car attached garage, living room, formal dining room, plus additional bonus space, over 2,000 square feet. West Bloomfield School District. Call Bill Gibson 851-5700 or 681-0473

**WEST BLOOMFIELD \$52,990 NOW BEING BUILT**  
 California contemporary 2 story, 3 bedrooms, 2 car attached garage, living room, formal dining room, plus additional bonus space, over 2,000 square feet. West Bloomfield School District. Call Bill Gibson 851-5700 or 681-0473

**WEST BLOOMFIELD \$59,235 NOW BEING BUILT**  
 2 story colonial, over 2,400 sq. ft., 3 bedrooms, 2 car attached garage, formal living room, formal dining room, plus additional bonus space. Lot size: 100 x 135'. Swim club privileges. Call Ted Alpert 851-6550

**WEST BLOOMFIELD \$59,235 NOW BEING BUILT**  
 2 story colonial, over 2,400 sq. ft., 3 bedrooms, 2 car attached garage, formal living room, formal dining room, plus additional bonus space. Lot size: 100 x 135'. Swim club privileges. Call Ted Alpert 851-6550

**FRANKLIN TOWN**, 4 bedroom, 2 1/2 baths, colonial with fireplace in family room, den, air conditioning attached garage. Immediate occupancy. \$85,000. Land Contract Available. By owner. 354-2910. 626-2816

**FRANKLIN TOWN**, 4 bedroom, 2 1/2 baths, colonial with fireplace in family room, den, air conditioning attached garage. Immediate occupancy. \$85,000. Land Contract Available. By owner. 354-2910. 626-2816

**FRANKLIN TOWN**, 4 bedroom, 2 1/2 baths, colonial with fireplace in family room, den, air conditioning attached garage. Immediate occupancy. \$85,000. Land Contract Available. By owner. 354-2910. 626-2816

**FRANKLIN TOWN**, 4 bedroom, 2 1/2 baths, colonial with fireplace in family room, den, air conditioning attached garage. Immediate occupancy. \$85,000. Land Contract Available. By owner. 354-2910. 626-2816

**FRANKLIN TOWN**, 4 bedroom, 2 1/2 baths, colonial with fireplace in family room, den, air conditioning attached garage. Immediate occupancy. \$85,000. Land Contract Available. By owner. 354-2910. 626-2816

**FRANKLIN TOWN**, 4 bedroom, 2 1/2 baths, colonial with fireplace in family room, den, air conditioning attached garage. Immediate occupancy. \$85,000. Land Contract Available. By owner. 354-2910. 626-2816

**FRANKLIN TOWN**, 4 bedroom, 2 1/2 baths, colonial with fireplace in family room, den, air conditioning attached garage. Immediate occupancy. \$85,000. Land Contract Available. By owner. 354-2910. 626-2816

**FRANKLIN TOWN**, 4 bedroom, 2 1/2 baths, colonial with fireplace in family room, den, air conditioning attached garage. Immediate occupancy. \$85,000. Land Contract Available. By owner. 354-2910. 626-2816

**FRANKLIN TOWN**, 4 bedroom, 2 1/2 baths, colonial with fireplace in family room, den, air conditioning attached garage. Immediate occupancy. \$85,000. Land Contract Available. By owner. 354-2910. 626-2816

**FRANKLIN TOWN**, 4 bedroom, 2 1/2 baths, colonial with fireplace in family room, den, air conditioning attached garage. Immediate occupancy. \$85,000. Land Contract Available. By owner. 354-2910. 626-2816

**FRANKLIN TOWN**, 4 bedroom, 2 1/2 baths, colonial with fireplace in family room, den, air conditioning attached garage. Immediate occupancy. \$85,000. Land Contract Available. By owner. 354-2910. 626-2816

**FRANKLIN TOWN**, 4 bedroom, 2 1/2 baths, colonial with fireplace in family room, den, air conditioning attached garage. Immediate occupancy. \$85,000. Land Contract Available. By owner. 354-2910. 626-2816

**FRANKLIN TOWN**, 4 bedroom, 2 1/2 baths, colonial with fireplace in family room, den, air conditioning attached garage. Immediate occupancy. \$85,000. Land Contract Available. By owner. 354-2910. 626-2816

**FRANKLIN TOWN**, 4 bedroom, 2 1/2 baths, colonial with fireplace in family room, den, air conditioning attached garage. Immediate occupancy. \$85,000. Land Contract Available. By owner. 354-2910. 626-2816

**306 Southfield Lathrup**  
 THREE bedroom brick ranch, 2 1/2 car garage, full basement, patio, 1 1/2 baths. Original owner. Home built 1981. \$35,900. After 6:30 pm. 558-3981

**EXCEPTIONALLY SHARP 4 BEDROOM COLONIAL** in Green Dolphin with many custom extras. Cozy fireplace family room, formal dining room, great kitchen with built ins, gorgeous glassed & screened porch and all on nicely landscaped cul-de-sac lot. Basement and attached garage, good occupancy. This will not last at this price. \$53,500. Call 478-8700.

**SPANISH** arched ranch, huge landscaped lot, beamed dining room, family room, 2 fireplaces, patio, attached garage, park-like setting. \$48,900. 558-0232

**LOVELY LARGE BEDROOM** 1 1/2 bath colonial. Large eat in kitchen, living room, paneled family room with wood burning fireplace, full basement, car attached garage, air conditioner and purifier, excellent carpeting throughout, fenced-in back yard, desirable young neighborhood with walking distance to school and shopping. \$44,500. 558-6008

**LOVELY LARGE BEDROOM** 1 1/2 bath colonial. Large eat in kitchen, living room, paneled family room with wood burning fireplace, full basement, car attached garage, air conditioner and purifier, excellent carpeting throughout, fenced-in back yard, desirable young neighborhood with walking distance to school and shopping. \$44,500. 558-6008

**ROCHESTER \$53,565 IMMEDIATE OCCUPANCY**  
 Builder's former model. Beautifully decorated two story colonial home with approximately 1,800 sq. ft. of living and bonus space. 3 bedrooms, 1 1/2 baths. Rochester Schools. Call Mike Lawrence at 652-4550 and ask about Lot #1146.

**BY OWNER**, Executive home. 4 bedrooms, 2 baths, Mediterranean Ranch. Cathedral ceilings, stone fireplace in family room, basement, 2 1/2 car garage, lake privileges. 6 months old. Transferred. \$90,000. \$14,000 down, L.C. terms. Buyers only. 641-7670

**ROCHESTER BY OWNER**, Professionally decorated Colonial in prestigious area. Huge family room with beamed Cathedral ceiling and fireplace. 3 bedrooms, 1 1/2 baths, full basement. Many extras including central air, walk to tennis and golf. \$87,900. Appointment only. 653-8885

**WIND MILL POINT**, Troy. Charming Cape Cod, 3 bedrooms, 2 baths, interesting floor plan. Family room fireplace. Carpeted country kitchen, all appliances, central air. \$48,900. By owner. 689-4885

**AT ROCHESTER**  
 Sharp 3 bedroom ranch with a fireplace. Big country kitchen, 2 car garage, Nearly 1/2 acre lot with trees. \$47,900. Weaver Real Estate 1340 Walton Blvd. Rochester 651-8140

**CUSTOM 1-1/2-ACRE** Cape Cod, 2,100 feet of unique features. Large bedrooms, beamed family room, 2 fireplaces, 2 1/2 baths, formal dining room, finished basement, attached garage. All on 1/4 acre, hilled, corner lot. \$75,000. Shown by appointment only. 678-4864

**ROCHESTER**, By owner, Wemberston. 1 year old 3 bedroom family room with fireplace, 2 1/2 baths, family room with fireplace, 2 1/2 car attached garage. Landscaped lot. 375-4229

**TROY** quad, by owner, 3 bedrooms, beamed family room, den or 4th bedroom, 2 1/2 baths, living room, full length fireplace with electric eye opener. In an established neighborhood near schools and freeways with many extras such as an in-ground, heated swimming pool. OPEN SUN 2-5 PM. 524-9674

**BY OWNER** - 4 bedroom, 2 1/2 bath colonial, air conditioned, paneled family room with fireplace, 1st floor laundry, intercom, finished basement, gas BBQ, attached rec room, garage with opener, fully decorated, mint condition. \$57,500. 558-2023

**WEST BLOOMFIELD \$52,990 NOW BEING BUILT**  
 California contemporary 2 story, 3 bedrooms, 2 car attached garage, living room, formal dining room, plus additional bonus space, over 2,000 square feet. West Bloomfield School District. Call Bill Gibson 851-5700 or 681-0473

**WEST BLOOMFIELD \$52,990 NOW BEING BUILT**  
 California contemporary 2 story, 3 bedrooms, 2 car attached garage, living room, formal dining room, plus additional bonus space, over 2,000 square feet. West Bloomfield School District. Call Bill Gibson 851-5700 or 681-0473

**WEST BLOOMFIELD \$59,235 NOW BEING BUILT**  
 2 story colonial, over 2,400 sq. ft., 3 bedrooms, 2 car attached garage, formal living room, formal dining room, plus additional bonus space. Lot size: 100 x 135'. Swim club privileges. Call Ted Alpert 851-6550

**FRANKLIN TOWN**, 4 bedroom, 2 1/2 baths, colonial with fireplace in family room, den, air conditioning attached garage. Immediate occupancy. \$85,000. Land Contract Available. By owner. 354-2910. 626-2816

**FRANKLIN TOWN**, 4 bedroom, 2 1/2 baths, colonial with fireplace in family room, den, air conditioning attached garage. Immediate occupancy. \$85,000. Land Contract Available. By owner. 354-2910. 626-2816

**FRANKLIN TOWN**, 4 bedroom, 2 1/2 baths, colonial with fireplace in family room, den, air conditioning attached garage. Immediate occupancy. \$85,000. Land Contract Available. By owner. 354-2910. 626-2816

**FRANKLIN TOWN**, 4 bedroom, 2 1/2 baths, colonial with fireplace in family room, den, air conditioning attached garage. Immediate occupancy. \$85,000. Land Contract Available. By owner. 354-2910. 626-2816

**FRANKLIN TOWN**, 4 bedroom, 2 1/2 baths, colonial with fireplace in family room, den, air conditioning attached garage. Immediate occupancy. \$85,000. Land Contract Available. By owner. 354-2910. 626-2816

**FRANKLIN TOWN**, 4 bedroom, 2 1/2 baths, colonial with fireplace in family room, den, air conditioning attached garage. Immediate occupancy. \$85,000. Land Contract Available. By owner. 354-2910. 626-2816

332 Mobile Homes For Sale
DARLING MOBILE HOMES
New 14 wide homes
FROM \$8,390

333 Lake River-Resort Property For Sale
MULLETT LAKE, 10 acre parcel, 200 ft. private beach access, near Indian River. From \$8500.

334 Country homes
103 YEAR OLD FARMHOUSE
In country. Linden area. Only 1/2 mile from Detroit.

335 Farms for sale
FOWLERVILLE, 69 acres, \$500 per acre. Land contract terms. 5/7/76.

336 Real Estate Wanted
DO YOU WANT ALL CASH NOW
for your house regardless of condition. We arrange all details confidentially and quickly.

337 Real Estate Wanted
DO YOU WANT ALL CASH NOW
for your house regardless of condition. We arrange all details confidentially and quickly.

338 Lots and Acreage For sale
MT. PLEASANT-MIDLAND AREA-2000 sq. ft. plus 2 1/2 acres, to 10 acres or 40 acres to 115 acres, reasonably priced. L.C. terms. TOWER. 478-5000

339 Real Estate Wanted
DO YOU WANT ALL CASH NOW
for your house regardless of condition. We arrange all details confidentially and quickly.

340 Apartments to rent
TELEGRAPH - Schoolcraft area. New one bedroom. Appliances, air conditioning, carpet, drapes. 538-5084

341 Real Estate Wanted
DO YOU WANT ALL CASH NOW
for your house regardless of condition. We arrange all details confidentially and quickly.

342 Cemetery lots
FOUR lots, Glen Eden Memorial Park, \$900. After 5. 349-8477

343 Commercial Industrial
BEAUTIFUL building on Woodward, N. of 10 Mile in Royal Oak, excellent location. Perfect for many businesses, health club, rental service.

344 Real Estate Wanted
DO YOU WANT ALL CASH NOW
for your house regardless of condition. We arrange all details confidentially and quickly.

345 Real Estate Wanted
DO YOU WANT ALL CASH NOW
for your house regardless of condition. We arrange all details confidentially and quickly.

346 Northern property
FORTY ACRES upper peninsula of Soo. Beautiful bay view, wooded, near main road. Hunting, boating, snowmobiling, sale-travel.

347 Real Estate Wanted
DO YOU WANT ALL CASH NOW
for your house regardless of condition. We arrange all details confidentially and quickly.

348 Real Estate Wanted
DO YOU WANT ALL CASH NOW
for your house regardless of condition. We arrange all details confidentially and quickly.

349 Real Estate Wanted
DO YOU WANT ALL CASH NOW
for your house regardless of condition. We arrange all details confidentially and quickly.

350 Real Estate Wanted
DO YOU WANT ALL CASH NOW
for your house regardless of condition. We arrange all details confidentially and quickly.

351 Real Estate Wanted
DO YOU WANT ALL CASH NOW
for your house regardless of condition. We arrange all details confidentially and quickly.

352 Real Estate Wanted
DO YOU WANT ALL CASH NOW
for your house regardless of condition. We arrange all details confidentially and quickly.

353 Real Estate Wanted
DO YOU WANT ALL CASH NOW
for your house regardless of condition. We arrange all details confidentially and quickly.

354 Real Estate Wanted
DO YOU WANT ALL CASH NOW
for your house regardless of condition. We arrange all details confidentially and quickly.

355 Real Estate Wanted
DO YOU WANT ALL CASH NOW
for your house regardless of condition. We arrange all details confidentially and quickly.

356 Real Estate Wanted
DO YOU WANT ALL CASH NOW
for your house regardless of condition. We arrange all details confidentially and quickly.

357 Real Estate Wanted
DO YOU WANT ALL CASH NOW
for your house regardless of condition. We arrange all details confidentially and quickly.

358 Real Estate Wanted
DO YOU WANT ALL CASH NOW
for your house regardless of condition. We arrange all details confidentially and quickly.

359 Real Estate Wanted
DO YOU WANT ALL CASH NOW
for your house regardless of condition. We arrange all details confidentially and quickly.

360 Real Estate Wanted
DO YOU WANT ALL CASH NOW
for your house regardless of condition. We arrange all details confidentially and quickly.

361 Real Estate Wanted
DO YOU WANT ALL CASH NOW
for your house regardless of condition. We arrange all details confidentially and quickly.

362 Real Estate Wanted
DO YOU WANT ALL CASH NOW
for your house regardless of condition. We arrange all details confidentially and quickly.

363 Real Estate Wanted
DO YOU WANT ALL CASH NOW
for your house regardless of condition. We arrange all details confidentially and quickly.

364 Real Estate Wanted
DO YOU WANT ALL CASH NOW
for your house regardless of condition. We arrange all details confidentially and quickly.

365 Real Estate Wanted
DO YOU WANT ALL CASH NOW
for your house regardless of condition. We arrange all details confidentially and quickly.

366 Real Estate Wanted
DO YOU WANT ALL CASH NOW
for your house regardless of condition. We arrange all details confidentially and quickly.

367 Real Estate Wanted
DO YOU WANT ALL CASH NOW
for your house regardless of condition. We arrange all details confidentially and quickly.

368 Real Estate Wanted
DO YOU WANT ALL CASH NOW
for your house regardless of condition. We arrange all details confidentially and quickly.

369 Real Estate Wanted
DO YOU WANT ALL CASH NOW
for your house regardless of condition. We arrange all details confidentially and quickly.

370 Real Estate Wanted
DO YOU WANT ALL CASH NOW
for your house regardless of condition. We arrange all details confidentially and quickly.

371 Real Estate Wanted
DO YOU WANT ALL CASH NOW
for your house regardless of condition. We arrange all details confidentially and quickly.

372 Real Estate Wanted
DO YOU WANT ALL CASH NOW
for your house regardless of condition. We arrange all details confidentially and quickly.

373 Real Estate Wanted
DO YOU WANT ALL CASH NOW
for your house regardless of condition. We arrange all details confidentially and quickly.

374 Real Estate Wanted
DO YOU WANT ALL CASH NOW
for your house regardless of condition. We arrange all details confidentially and quickly.

375 Real Estate Wanted
DO YOU WANT ALL CASH NOW
for your house regardless of condition. We arrange all details confidentially and quickly.

376 Real Estate Wanted
DO YOU WANT ALL CASH NOW
for your house regardless of condition. We arrange all details confidentially and quickly.

377 Real Estate Wanted
DO YOU WANT ALL CASH NOW
for your house regardless of condition. We arrange all details confidentially and quickly.

378 Real Estate Wanted
DO YOU WANT ALL CASH NOW
for your house regardless of condition. We arrange all details confidentially and quickly.

379 Real Estate Wanted
DO YOU WANT ALL CASH NOW
for your house regardless of condition. We arrange all details confidentially and quickly.

380 Real Estate Wanted
DO YOU WANT ALL CASH NOW
for your house regardless of condition. We arrange all details confidentially and quickly.

381 Real Estate Wanted
DO YOU WANT ALL CASH NOW
for your house regardless of condition. We arrange all details confidentially and quickly.

382 Real Estate Wanted
DO YOU WANT ALL CASH NOW
for your house regardless of condition. We arrange all details confidentially and quickly.

383 Real Estate Wanted
DO YOU WANT ALL CASH NOW
for your house regardless of condition. We arrange all details confidentially and quickly.

384 Real Estate Wanted
DO YOU WANT ALL CASH NOW
for your house regardless of condition. We arrange all details confidentially and quickly.

385 Real Estate Wanted
DO YOU WANT ALL CASH NOW
for your house regardless of condition. We arrange all details confidentially and quickly.

386 Real Estate Wanted
DO YOU WANT ALL CASH NOW
for your house regardless of condition. We arrange all details confidentially and quickly.

387 Real Estate Wanted
DO YOU WANT ALL CASH NOW
for your house regardless of condition. We arrange all details confidentially and quickly.

388 Real Estate Wanted
DO YOU WANT ALL CASH NOW
for your house regardless of condition. We arrange all details confidentially and quickly.

389 Real Estate Wanted
DO YOU WANT ALL CASH NOW
for your house regardless of condition. We arrange all details confidentially and quickly.

390 Real Estate Wanted
DO YOU WANT ALL CASH NOW
for your house regardless of condition. We arrange all details confidentially and quickly.

391 Real Estate Wanted
DO YOU WANT ALL CASH NOW
for your house regardless of condition. We arrange all details confidentially and quickly.

392 Real Estate Wanted
DO YOU WANT ALL CASH NOW
for your house regardless of condition. We arrange all details confidentially and quickly.

393 Real Estate Wanted
DO YOU WANT ALL CASH NOW
for your house regardless of condition. We arrange all details confidentially and quickly.

394 Real Estate Wanted
DO YOU WANT ALL CASH NOW
for your house regardless of condition. We arrange all details confidentially and quickly.

395 Real Estate Wanted
DO YOU WANT ALL CASH NOW
for your house regardless of condition. We arrange all details confidentially and quickly.

396 Real Estate Wanted
DO YOU WANT ALL CASH NOW
for your house regardless of condition. We arrange all details confidentially and quickly.

397 Real Estate Wanted
DO YOU WANT ALL CASH NOW
for your house regardless of condition. We arrange all details confidentially and quickly.

398 Real Estate Wanted
DO YOU WANT ALL CASH NOW
for your house regardless of condition. We arrange all details confidentially and quickly.

399 Real Estate Wanted
DO YOU WANT ALL CASH NOW
for your house regardless of condition. We arrange all details confidentially and quickly.

400 Real Estate Wanted
DO YOU WANT ALL CASH NOW
for your house regardless of condition. We arrange all details confidentially and quickly.

401 Real Estate Wanted
DO YOU WANT ALL CASH NOW
for your house regardless of condition. We arrange all details confidentially and quickly.

402 Real Estate Wanted
DO YOU WANT ALL CASH NOW
for your house regardless of condition. We arrange all details confidentially and quickly.

403 Real Estate Wanted
DO YOU WANT ALL CASH NOW
for your house regardless of condition. We arrange all details confidentially and quickly.

404 Real Estate Wanted
DO YOU WANT ALL CASH NOW
for your house regardless of condition. We arrange all details confidentially and quickly.

405 Real Estate Wanted
DO YOU WANT ALL CASH NOW
for your house regardless of condition. We arrange all details confidentially and quickly.

406 Real Estate Wanted
DO YOU WANT ALL CASH NOW
for your house regardless of condition. We arrange all details confidentially and quickly.

407 Real Estate Wanted
DO YOU WANT ALL CASH NOW
for your house regardless of condition. We arrange all details confidentially and quickly.

408 Real Estate Wanted
DO YOU WANT ALL CASH NOW
for your house regardless of condition. We arrange all details confidentially and quickly.

409 Real Estate Wanted
DO YOU WANT ALL CASH NOW
for your house regardless of condition. We arrange all details confidentially and quickly.

410 Real Estate Wanted
DO YOU WANT ALL CASH NOW
for your house regardless of condition. We arrange all details confidentially and quickly.

411 Real Estate Wanted
DO YOU WANT ALL CASH NOW
for your house regardless of condition. We arrange all details confidentially and quickly.

412 Real Estate Wanted
DO YOU WANT ALL CASH NOW
for your house regardless of condition. We arrange all details confidentially and quickly.

413 Real Estate Wanted
DO YOU WANT ALL CASH NOW
for your house regardless of condition. We arrange all details confidentially and quickly.

414 Real Estate Wanted
DO YOU WANT ALL CASH NOW
for your house regardless of condition. We arrange all details confidentially and quickly.

415 Real Estate Wanted
DO YOU WANT ALL CASH NOW
for your house regardless of condition. We arrange all details confidentially and quickly.

416 Real Estate Wanted
DO YOU WANT ALL CASH NOW
for your house regardless of condition. We arrange all details confidentially and quickly.

417 Real Estate Wanted
DO YOU WANT ALL CASH NOW
for your house regardless of condition. We arrange all details confidentially and quickly.

418 Real Estate Wanted
DO YOU WANT ALL CASH NOW
for your house regardless of condition. We arrange all details confidentially and quickly.

419 Real Estate Wanted
DO YOU WANT ALL CASH NOW
for your house regardless of condition. We arrange all details confidentially and quickly.

420 Real Estate Wanted
DO YOU WANT ALL CASH NOW
for your house regardless of condition. We arrange all details confidentially and quickly.

Doctor, lease a medical suite in Farmington Hills that can be sized (800 sq. ft. to 3,000 sq. ft.) for your particular needs and more than 15 minutes from any NW area hospital.

QUAST REALTORS 478-1040
FOR YOUR HOME! NO Points - No Commission CALL KEN DIVOICK

T.N. INDUSTRIAL OFFICES
7,500 Sq. Ft. Central air conditioned, computerized throughout, ideal for industrial clinic, computer operations, engineering offices, etc.

RIVER BEND APARTMENTS
Luxuriously carpeted and draped 1 and 2 bedroom apartments and 2 bedrooms with bath. Hottest appliances, glass door walk in balconies, walk-in closets, imposing communal pool and swimming pool exclusively for residents.

500 Help wanted

YOUNG PEOPLE Male & female, needed for telephone soliciting. Weekdays 4 to 8 PM. Excellent salary plus commission. Schoolcraft, Inkster area. Call for interview. 522-5060

500 Help wanted

WAITRESS for buffet. Apply in person. Roma's of Bloomfield, 2101 S. Telegraph. N. of Sq. Lake Rd.

500 Help wanted

DUNKIN' DONUTS Full-time, women needed, 6:30 AM-3 PM, Mon. thru Fri. Apply in person, 9 AM-2 PM at: 34417 Ford Rd. Westland

500 Help wanted

HOSTESS for model home. Apply in person 24 PM 2008 Babcock, 2 blocks north of Big Beaver off Coolidge. Troy

500 Help wanted

MECHANICAL ENGINEER Chief Mechanical Engineer with local established consulting engineering firm for building construction projects and energy conservation analysis.

500 Help wanted

MECHANICAL BOOKKEEPER / OFFICE MANAGER Experienced in bookkeeping and medical office management required for busy 4 doctor clinic. Excellent salary and working conditions.

502 Help Wanted

ASCP MED TECH Blood chemistry. Hematology experience required for clinic lab 5 days, no weekends. Excellent salary and benefits. Fee paid. Dr. Personnel Agency, Northland Medical Bldg. 353-0850

504 Help Wanted

SECRETARY for Troy advertising agency, Gorgonzola new office. Requirements: 13+ average shorthand, good typing, some accounting experience. Salary \$600 to \$700, excellent benefits, and fee paid.

504 Help Wanted

INSURANCE GIRL: Girl with personal lines experience (home owners and auto). 7 1/2 hours per day. 5 days a week. Call. 558-4650

504 Help Wanted

LIVONIA AREA Automotive supplier requires a full time, experienced Secretary with good shorthand, typing and general office skills for its sales office. Send resume to: Box 450, Observer & Eccentric Newspapers, 36251 Schoolcraft, Livonia, Michigan 48150

Salesperson

Experienced for Women's Ready to Wear store. Top pay. Apply. Nadon's Oakland Mall

MASS HIRING

Need 21 men - women to fill vacancies left by promotions. Our new sales office is expanding and we might need you to find out more. Call Tuesday only - 10 to 5 PM. 425-8888

REPAIRMAN

for vacuums, polishers etc. Must be neat, reliable & have good work record. This is a steady job with good future. Call Mr. Roberts, between 85 Monday through Friday. 474-7400

COOK WANTED

Apply in person, 1315 S. Telegraph, N. of Sq. Lake Rd. 474-7400

Surface Grinder Operator

Experienced on precision machined parts. No other need apply. HYTRON MANUFACTURING INC. 18335 Weaver, Detroit 272-7330

Tool & Die Maker

Must Be Experienced Journeyman. Excellent fringe benefits. Steady Work. All Products 12238 Woodbine, Telegraph-Plymouth Area

LAYOUT MAN

For fabrication shop. Qualifications: Must read blue prints, fit and weld. Others need not apply. WELD-DUN WELDING CO. 17715 Dora, Melvindale Du 1-8077

GLOBETROTTER TICKET WINNER

Scott Parzuchowski 30525 Elmira Livonia, MI 48150

COOKS & BUS BOYS

Apply in person, 2078 FARMINGTON RD., NEAR 8 MILE RD. BEAUTY OPERATOR wanted, call after 4 453-9229

CONGRATULATIONS!

TRAINEE POSITION open. College degree in Business Administration. Must be neat and well groomed. \$9000. all benefits plus car. Fee Paid. Beryl Personnel, 427-N Woodward, Royal Oak. 576-0270

WAITERS WAITRESSES

Full-Time, Midnight Shift. If you have a good POSITIVE ATTITUDE and the WILLINGNESS TO LEARN, you'll enjoy working with our friendly staff in our popular family restaurant.

MECHANICS

For construction & Utility Hydraulic Equipment. Experience required. 476-6380

INSURANCE

COMMERCIAL PACKAGE RATER. Commercial package rater with 2 or more years experience. Excellent salary. Negotiable depending upon experience and ability. RELIANCE INSURANCE CO. 1200 Sixth Ave., Detroit 696-2570

DETAILER

on assembly machines and parts feeders. Established 20 year old, Southfield firm. Steady work, paid vacations, holidays, Blue Cross, life insurance and sick benefits. 444-4534

MANAGER

For Company owned Station in Birmingham. Must be mature with good references. Good Salary, Medical Insurance, Vacation. 689-5805

LANDSCAPE MAINTENANCE

Work for summer. Must be 18 or 18 years. Call between 1-4 PM. 261-2814

RECEPTIONIST

for busy 3 doctor office. Must have good references. Good Salary, Medical Insurance, Vacation. Apply: Arthur C. Frock, Assistant Superintendent for Personnel, 15125 Farmington Rd., Livonia 48154. 422-1200 ext. 221

SECRETARY

for new law partner for fast growing firm. No experience in legal necessary but helpful. Good typing a must. Excellent hours, benefits and salary up to \$7800. Company pays our costs. Call Barbara Good - Professional Personnel. 357-4810

HAIRDRESSERS

male and female with following 12 Mile Evergreen Plaza. 557-8536-57

STUDENTS

Part-time evenings, Westside Detroit, hourly wage paid for telephone sales campaign 5:30 - 9 pm weekdays. Call 552-4006 before 4:30 ONLY. Ask for Mr. Forbes.

WORKING FOREMAN

- experienced in light assembly, shipping, receiving, production scheduling and packaging. Must have supervisory experience and be good with people. Send salary and history resume to: Box 460, Observer & Eccentric Newspapers, 36251 Schoolcraft, Livonia, Michigan 48150.

SECRETARY

for new law partner for fast growing firm. No experience in legal necessary but helpful. Good typing a must. Excellent hours, benefits and salary up to \$7800. Company pays our costs. Call Barbara Good - Professional Personnel. 357-4810

SECRETARY

for new law partner for fast growing firm. No experience in legal necessary but helpful. Good typing a must. Excellent hours, benefits and salary up to \$7800. Company pays our costs. Call Barbara Good - Professional Personnel. 357-4810

SECRETARY

for new law partner for fast growing firm. No experience in legal necessary but helpful. Good typing a must. Excellent hours, benefits and salary up to \$7800. Company pays our costs. Call Barbara Good - Professional Personnel. 357-4810

SECRETARY

for new law partner for fast growing firm. No experience in legal necessary but helpful. Good typing a must. Excellent hours, benefits and salary up to \$7800. Company pays our costs. Call Barbara Good - Professional Personnel. 357-4810

SECRETARY

for new law partner for fast growing firm. No experience in legal necessary but helpful. Good typing a must. Excellent hours, benefits and salary up to \$7800. Company pays our costs. Call Barbara Good - Professional Personnel. 357-4810

SECRETARY

for new law partner for fast growing firm. No experience in legal necessary but helpful. Good typing a must. Excellent hours, benefits and salary up to \$7800. Company pays our costs. Call Barbara Good - Professional Personnel. 357-4810

Want Ads Pile Up Cash! 15 WORDS 2 ISSUES \$6.00. Dispose of your "extras" with a TWIN ACTION CLASSIFIED.

The Observer & Eccentric Classifieds. OAKLAND COUNTY 644-1070 • WAYNE COUNTY 522-0900. (Or, if you're calling from Rochester or Avon Twp., dial 852-3222 Toll Free.)

504 Help Wanted Office-Clerical
BOOKKEEPER Full Charge with knowledge of EDP and A/P...
PERSONALITY PLUS good accuracy typing...

504 Help Wanted Office-Clerical
RECEPTIONIST with P.B.X. and secretarial experience Mrs. Davis...
S'FIELD BEGINNER No experience, no shorthand...

504 Help Wanted Office-Clerical
STENO Neat, accurate typist, mature, personable...
SECRETARY TO BE TRAINED as Jr. Legal Assistant...

504 Help Wanted Office-Clerical
STENOS Immediate Openings In Your Area Interviewing Daily 9-3...

506 Help Wanted Sales
FOOD RELATED Institutional degree, metro. sales experience \$10,000 UP...

506 Help Wanted Sales
TIRED Of excuses as to why real estate companies cannot provide the tools necessary to become a professional success?

506 Help Wanted Sales
SOUTHFIELD LATHRUP AREA The Lathrup office of Earl Keim Realty, one of 25 Earl Keim offices...

506 Help Wanted Sales
LEARN REAL ESTATE Broker of state aggressive office, teaches for State license WE will continue your sales training...

508 Help Wanted Domestic
BABY SITTER For Family 4 days per week 2-4 PM no weekends Light housekeeping...

Secretary Bank Holding Company Subsidiary seeking Secretary Typing with at least 2 years recent office experience...

LOVONIA LOVELY \$750/MO. If you have previous experience with title or mortgage company you are eligible...

Aglo Restaurants 23600 Telegraph Rd Southfield 48075
SECRETARY for Southfield law firm. Must have good typing skills 80 to 70 wpm...

TYPISTS Immediate Openings In Your Area Interviewing Daily 9-3 See Maryann Burns...

chamberlain MATURE woman to work in Store's Ice Cream Store, 1464 Sheldon Rd. Sheldon and Ann Arbor Rd. area...

RYMAL SYMES Realtors Since 1923 I would like to train women to be distributors of Shakie Products...

Real Estate "PROFESSIONALS" Proven million dollar producer offers the prestige of your own private office...

507 Help Wanted Part Time PERSON to assist in grooming and care of pets. Must be Livonia area. Will train. Send Resume to Box 490...

508 Help Wanted Domestic BABY SITTER needed 1 full time afternoon, my home 1 toddler. Burt Rd. Schoolcraft area. Call before 2 PM...

506 Help Wanted Sales SUPER nice boss will train you completely for interesting job in general office. Answer phones, type, some filing and figure work...

Customer Relations Sec's receptionist job requires more than just typing ability. If you have poise and lots of cool, you are just what we need...

506 Help Wanted Sales SALESWOMAN Sharp Aggressive over 25 with real experience to sell carpet, light fixtures wallpaper, drapes. Salary plus commission. Mr. Borlack 477-6503

LEGAL Secretaries We have many fine openings for experienced legal secretaries with good skills. Ask for Grace Hillstrom & Ross Agency...

REAL ESTATE Highest Commissions. Good plan for high earners. Will train in Michigan's finest Real Estate School. If you are willing to work, you are able to earn extremely high income. Call Gene Darke for details. 525-7700

AVON Line your Easter basket with valuable 'green'. Sell popular products in your own area. Excellent earnings. Call today! 645-0455 422-2252

QUAST REALTORS 18 hours, 538-2000 PART-TIME 18 hours, working students. Giving plant 685-2268

508 Help Wanted Domestic MATURE companion good at bridge for healthy female senior citizen. Thru each or every other week. Daylight hours flexible. Possible days weekly if light housekeeping and companion duties combined with minimum of 4 hours. Birmingham, Bloomfield area. Own car. Mrs Ford 646-9609

508 Help Wanted Domestic BABY SITTER wanted Tuesday and Thursday afternoons. Must provide own transportation. Southfield area. 334-0435

CAREER OPPORTUNITY Can You Imagine making two families happy on the same day, and getting paid for it? That's what Real Estate is like, and we would like to tell you more about it. Attend our next Career Seminar on Tuesday, April 6, 7:30 p.m. at 33620 Five Mile (W. of Farmington Road). Call Mr. Appicelli at 261-2100 for your complimentary reservation.

GENL SECRETARY Farmington Hills based shopping center developer is looking for a secretary with excellent shorthand, typing and bookkeeping skills. Her responsibilities include business correspondence, telephone and personal receptionist, and general bookkeeping. Salary \$650-\$730. Call for interview 851-8800

Major Appliance SALESMEN Both full and part-time positions available. Experience preferred but will train. Ask for Mr. Etue at Larkins Lindy Berry's Appliance, 28225 Orchard Lake Rd. Farmington Hills 478-3310

Century 21 Gene Darke Realty LADIES-Inflation stretching budget to breaking point? 3 or 4 hours a day will bring you a profitable income. For details write Box 10, Watkins Products, Inc., Winona, Minn. 55987

PRUDENTIAL We are currently looking for alert, aggressive and ambitious individuals who are college graduates or at least reasonably well-educated by the business world. They may be currently employed and impatient to rise above the challenge potential and financial reward inherent in just ANY JOB. We professionally train in estate, business and corporate planning, taxation, pensions, etc. Starting salary commensurate with ability and qualifications. Continuing supervision and field assistance. Executive office facilities. Call Ken Schweiger 257-5000 Equal Opportunity Employer M.F.

1st UNITED JOHN COLE REALTY 25105 W. 6 Mile, Redford 255-5330 SOPHISTICATED and experienced salespeople interested in placing Fine Art in businesses and homes. Straight commission. Call Mr. Berk 642-2838

508 Help Wanted Domestic MATURE woman for light housework and companion care. 5 PM to 10 PM, 5 days. Own transportation. Farmington area. Call mornings 474-4652

508 Help Wanted Domestic MARRIED COUPLE to live in and act as chauffeur/gardener, cook and housekeeper. Comfortable quarters, good wages, benefits. Written references required. Respond to Box 440. Observer & Eccentric PM Monday through Friday. Livonia, Michigan 48150

Home & Service Guide

Accounting Service BOOKKEEPING Any part of up to incl profit & loss statements. Exp in insurance billing 435-6239

Asphalt CHAMPION PAVING CO Winter Prices in Effect Until May 15th Terms Available 5 Star salesman about our 5 yr warranty plan. \*Parking lots \*Sealcoating & repairs 474-6222

Basement Waterproofing Do You Have a WET BASEMENT? We will repair it right the first time! Call Oasis Bldg. Co. 522-6570

Brick, Block & Cement CEMENT WORK ALL KINDS New or Replacement Also Custom Built Garages. Ross & Caulder Have my price before you buy compare and save \$\$\$

Building & Remodeling DAGUANO & SONS INC Residential/Commercial Licensed 422-5713 352-2299

Building & Remodeling COMPLETE MODERNIZATION PRICED WITHIN REASON COMPLETED TO KITCHENS CUSTOM KITCHENS

Carpentry KITCHEN BATH SPECIALIST Formica cabinets, install dish washers, Any size job 728-9310

Carpet Cleaning METRO Cleaning Service. Carpet cleaning & upholstery cleaning. Window cleaning. Free estimates. 458-9274

Electrical LICENSED Electrical contractor. All types of work. Good service. Good prices. Canton Township. 458-9274

Advertising ADVERTISING CREATIVE & INEXPENSIVE 582-7943 682-9397 476-6871

Base Asphalt Paving, Inc. Our 17th consecutive year of advertising. Construction of new asphalt parking lots and driveways. Resurfacing of existing asphalt and concrete driveways. Genuine seal coating. Workmanship and materials guaranteed. Reference list of recent work available. Ask our customers about us. W 12 Mile cor Northwestern El 3-7829 EL 6-8641

Bicycle Maintenance CONTINENTAL CYCLERY Professional mechanics and reasonable rates. Pick-up or home repair. 464-0712

Brick, Block & Cement SOAVE CEMENT work First quality work. Porches, patios, driveways, brick and block. New and repair. 476-3586

Deal Direct Kitchens, Bathrooms, Formica and Solid Oak Cabinets and Vanities. FACTORY CLOSOUTS 40%-50% DISCOUNT

Burglar & Fire Alarm HOME GUARD ALARMS Do-It-Yourself kit complete \$99 B.R.K. Smoke detector \$49 We deliver. See displays of above items at 18715 GRAND RIVER 272-0113

Carpet Repair CHUCK'S CARPET REPAIR Any repair large or small. Residential or commercial. 464-3815

Carpet Cleaning CARPETIME INC Professional cleaning for drapes, carpets & upholstery. Established 23 years. Anytime day or night. Free estimates. 836-3773

Excavating ALL TYPES of EXCAVATING Sewer work, Bulldozing, Grading, Dirt & Stone hauled. DRIVEWAYS Graveled & Graded. Reasonable Prices. 477-2208

Asphalt ALUM SIDING 100 sq ft installed \$88 STORM WINDOWS PORCH ENCLOSURES CARPENTRY Free Estimates WORK MYSELF 453-8487

Basement Waterproofing MAHON REPAIR CONTRACTOR Basement Leaks Repaired, Walls Treated, Visqueured Masonry & Cement Repair Work 5 YR GUARANTEE 478-5778

Brick, Block & Cement CORE CONCRETE CONSTRUCTION INC. Commercial residential. Driveways, basements, floors, garage, footings, ratwalls etc. Lac. Bonded. Insured. Daguano & Sons Inc. Residential/Commercial Licensed 422-5713 352-2299

Brick, Block & Cement ITALIAN CEMENT CO. LICENSED-INSURED BONDED. FREE ESTIMATE 356-0396 532-7499

Building & Remodeling MARS BUILDING COMPANY Residential/Commercial Additions, Kitchens, Dormers, Rec Rooms, Baths, Siding. FREE ESTIMATES. PROMPT SERVICE 538-2666 626-7044

Building & Remodeling CARPENTRY ROUGH & FINISH COMMERCIAL INDUSTRIAL Residential Maintenance. Ray's Construction 261-4230

Carpet Repair CARPETIME INC Professional cleaning for drapes, carpets & upholstery. Established 23 years. Anytime day or night. Free estimates. 836-3773

Carpet Cleaning CARPETIME INC Professional cleaning for drapes, carpets & upholstery. Established 23 years. Anytime day or night. Free estimates. 836-3773

Excavating ALL TYPES of EXCAVATING Sewer work, Bulldozing, Grading, Dirt & Stone hauled. DRIVEWAYS Graveled & Graded. Reasonable Prices. 477-2208

Asphalt ALUM SIDING 100 sq ft installed \$88 STORM WINDOWS PORCH ENCLOSURES CARPENTRY Free Estimates WORK MYSELF 453-8487

Basement Waterproofing MAHON REPAIR CONTRACTOR Basement Leaks Repaired, Walls Treated, Visqueured Masonry & Cement Repair Work 5 YR GUARANTEE 478-5778

Brick, Block & Cement CORE CONCRETE CONSTRUCTION INC. Commercial residential. Driveways, basements, floors, garage, footings, ratwalls etc. Lac. Bonded. Insured. Daguano & Sons Inc. Residential/Commercial Licensed 422-5713 352-2299

Brick, Block & Cement ITALIAN CEMENT CO. LICENSED-INSURED BONDED. FREE ESTIMATE 356-0396 532-7499

Building & Remodeling MARS BUILDING COMPANY Residential/Commercial Additions, Kitchens, Dormers, Rec Rooms, Baths, Siding. FREE ESTIMATES. PROMPT SERVICE 538-2666 626-7044

Building & Remodeling CARPENTRY ROUGH & FINISH COMMERCIAL INDUSTRIAL Residential Maintenance. Ray's Construction 261-4230

Carpet Repair CHUCK'S CARPET REPAIR Any repair large or small. Residential or commercial. 464-3815

Carpet Cleaning CARPETIME INC Professional cleaning for drapes, carpets & upholstery. Established 23 years. Anytime day or night. Free estimates. 836-3773

Excavating ALL TYPES of EXCAVATING Sewer work, Bulldozing, Grading, Dirt & Stone hauled. DRIVEWAYS Graveled & Graded. Reasonable Prices. 477-2208

MORE ADS ON NEXT PAGE

508 Help Wanted Domestic

WANTED: BABYSITTER, full time, Tues - Sat, 8 AM - 5 PM. Own transportation. Canton area. 728-9002

510 Help Wanted Couples

WORKING husband with wife for motel duties. Apartment plus utilities and \$300 monthly Northwest suburb. Lois Ray Personnel, 558-0560

CARETAKER COUPLE

for high rise apartment complex in Southfield. Man for maintenance work, wife for cleaning. No children or pets. Salary, apartment and other benefits. Call Days 557-8100

MIDDLE-AGED manager couple

for 28 unit suburban apartment project. Husband must be knowledgeable in heating, maintenance and painting. Wife will handle rentals and cleaning. Previous experience preferred. No children or pets. Please For information 557-9682 After 6 PM.

OLDER COUPLE to manage small northern suburban apartment complex

60 units. Husband need not present job. Apartment and salary included. Mr. Weinberg, 558-0855

COUPLE for large apartment complex in Southfield

Man with experience in mechanical maintenance. Woman to work in office as assistant manager in all phases of rental. Light typing required. Salary apartment with all utilities paid. Please call 558-4954 for appointment.

512 Situations Wanted Female

GRANDMOTHER wishes baby-sitting 3 years and up Plymouth, Canton area. full-time. Own transportation. 453-3749

BABY SITTER, days only

Mon thru Friday. Transportation. Lots of playmates, large fenced yard, references. Westland area. 427-0204

BABY SITTING JOBS WANTED

DAYS IN MY LICENSURE HOME - NEAR 7 MILE & INKSTER. CALL 531-0626

ALTERATIONS, low rates, call weekdays after 6PM

Ask for Vicki, 532-2822

TYPING DONE IN MY HOME

of Bloomfield Area. 628-5381

"Personalized Maid Service"

Birch, 477-5307. "Service You Can Trust"

DAY care for pre-schoolers

motherly, individual attention. Playmate, 2 acre fenced play yard. Licensed 9 years. Wayne/Joy Rd. area. 522-3044

NURSES

PRIVATE DUTY, ANY SHIFT. Live in Companions-Domestics. Vacation Sitters. New Born Care. Party Help.

LIMAR INC.

647-3540

512 Situations Wanted Female

MATURE WOMAN WILL sit for vacationing parents. Experienced. References. Has own transportation, or will live-in. 858-8322

BEST MAIDS brings the best to you

Experienced personnel. Fully insured. Transportation furnished. 968-0151

TYPING IN MY HOME

Professional Accurate Results. Former Legal Secretary. 576-1946

PART-TIME office work

mature woman, reliable and experienced. No benefits. Reply to Box 83, Northville, Mich. 48167

BOOKKEEPER, Part-time

All phases through Financials. Experienced. References. Weekly or monthly basis. Systems set up. Small businesses. 568-7799

LOVING Childcare in my licensed home

Bloomfield area. Call Birmingham, Michigan. 855-1873

DAILY or vacation care of children

conscientious and elderly. Also pet-sitting, your home. Reasonable rates. Liberty Agency, weekdays. August, Larry, 356-1470

514 Situations Wanted Male

COLLEGE Architectural student, drafting experience. Desires summer on the job construction - timekeeping experience. Available May. August, Larry, 421-8572

I.B.W. - L.U. 58, Desperate

11 years experience with a card classification. 85% Romex, 15% Commercial. Union contractors only. Write to: Hiram, P.O. Box 562, Wayne, MI 48184

RETIRED BUSINESS manager

will address and staff your envelopes, can pick up and deliver. 453-7369

ACCOUNTING Graduate seeks entry level position

with firm. Hard worker. 348-2764

CARPENTER & Painter, 15 yrs exp

Basements paneled, suspended ceilings, kitchen cabinets refinished, etc. Free est. 453-7856

518 Education Instructions

MATH TUTORING, all grades. MA-B.S. degrees. Certified experienced teacher. Call evenings. 545-3888

CERAMIC CLASSES, Mon 10AM-12:30

Tues 7PM - 9:30 PM. Still a few openings. Beginners & Advanced. New techniques. Greenware and Firings. 349-2727

AIRLINE TICKETING

Travel Agent. American Travel Schools. 2292 Woodward. Ferndale. 453-3749

ENGLISH READING Tutor

experienced, certified teacher. Phi Beta Kappa. MSU grad. 642-8087

IBM KEYPUNCH

Learn Now - Work in Weeks. DAY & EVENING CLASSES. FREE APPLICATION ASSISTANCE. LIVONIA BUSINESS MACHINES INSTITUTE. 32114 Plymouth Rd. 261-6330

EXPERIENCED piano teacher

will address and staff your envelopes, can pick up and deliver. 453-7369

DAY CAMP RIDING PROGRAM

Formal instructions. Cross country. Games on horseback. Age 16 and under. Call Celia, 651-3398

600 Personals

DATING SINGLES. Meet your kind of people today and date next week. Low \$25 fee. DATE-MATE, INC. 349-2070

ASTROLOGY READINGS

horoscopes cast and interpreted. Call 427-7774 for an appointment.

ELECT ANN DROPIEWSKI

Birmingham City Commission EXPERIENCED, DEDICATED RESPONSIBLE. VOTE MON APRIL 5

LIVE YOUR LIFE according to its natural rhythms

Your personal Bio-Rhythms charted for one year. Enclose date of birth and \$12.50. R. Turk, 477 W Forest, Detroit 48201

602 Lost & Found

LOST: white, friendly neutered male cat, red collar. Plymouth, Wayne Rd. area. 527-4714

FOUND: male Malamute on OCC Orchard Ridge Campus.

561-1859

LOST: Siamese female, 6 mo. pet.

Victory Middlebelt, Joy Rd. area. Reward. Answers to Joy Rd. 421-6569 422-4800

FOUND: gold bracelet at Wonder-Land Center.

322-4100

FOUND: Schoolcraft - Levan, small shaggy female dog.

425-8194

LOST: Maple Orchard Lake area.

large long haired brown tiger, front paws de-clawed. Reward. 626-7421

LOST: Weimaraner, vicinity 13 Mile - Lahser Road.

641-2039

LOST: March 9, Beagle, tricolor male, very small, Garden City area.

Please return, child giving. Reward. 522-1731

REWARD! Lost March 25, cat

large white long haired, neutered. Blueberry Circle, Plymouth, N. poleon. 981-0557

FOUND: Small black and white dog

well trained. Found 1st of February. Livonia vicinity. 591-6360

LOST: black female German Shepherd

no collar, vicinity 17 Mile - Meadowbrook. Novi. 478-2790 or 476-1281

LOST: YOUNG, small male dog

Inkster, 6 mile area. Black with white streak down stomach. Children's pet. 261-3325

FOUND: white female poodle

Redford Twp. area. 937-9555

FOUND: Orange part Persian male cat

Walks with limp. Answers to Pumpkin. Reward. 478-5308

FOUND: Brownish black male cat

Rochester area, 651-2169 or 651-5329

616 Hall for rent

FREE SPACE FOR PARTIES, WEDDINGS, SHOWERS & OTHER FUNCTIONS. LINCOLN INN. Southfield & Dix. Reservations. 386-5000

622 Income Tax & Insurance

THURSDAY NIGHTS 7 PM. Novi Community Organization. 26360 Novi Rd., Novi.

624 Professional Services

DATSON, 1975, B-210 Hatchback, 12,000 miles, automatic, AM-FM, rustproofed. \$1,895. O'Hara Datsun.

626 Bingo

BINGO EVERY TUES NIGHT. Early Bird 7 PM Church of St. Priscilla, 19120 Purlingwood, Livonia. W of Livonia Mall.

ST. EDITH BINGO

SUN 6:30 PM WED 7 PM 15089 Newburgh Rd., Livonia

BINGO EVERY SUNDAY 7 PM

HILLEL DAY SCHOOL. 32200 Middlebelt, Farm Hills N of Northwestern Hwy.

WEDNESDAY 7:15 PM

Brother Rice High School. 7101 Lahser Rd., Birmingham. Between Maple & 14 Mile

MONDAYS 7:30 PM

BETH ABRAHAM HILLEL. 5075 W MAPLE RD. (Between Middlebelt & Inkster)

EVERY TUES 7 PM

Livonia Post 394 VFW. 27555 Grandlind, Blvd W of Inkster Rd. between Plymouth Rd & Schoolcraft

628 Entertainment

THE GINGER BRANDY BAND. Specialty wedding receptions, class reunions. Standards, rock & oldies. 563-1176

PARTY ENTERTAINMENT

Mind Reading? Hypnotism? Close-Up Magic? By Bill Nagler. Ord. Day Magic & Balloons. By Billy the Clown. 369-1719, 1-682-3700

FULL YOUTH OF EXCELLENT MUSIC

and entertainment. Experience in providing the finest music for all social occasions. Jerry, Ulta, 731-6081

BLUE MENAGERIE BAND

MUSIC FOR ALL AGES. The perfect band for your wedding. Dave. 525-6524, 937-2642

NOVA THE MAGICIAN

ENTERTAINMENT FOR CLUBS, Parties, Schools. Children's shows, a specialty.

GOO PROFESSIONAL MUSIC & ENTERTAINMENT

for all occasions. Call Don Mills. 476-2860

702 Antiques

Sotheby Parke Bernet. Will appraise your treasures for jobs in small. - Bloomfield Art Association. April 9, 10, 11, Fri., Sat and Sun 10:30 to 4 PM 1516 S Cranbrook Rd. 444-0866

VICTORIAN furniture, chests, ladies desk, sewing table, with in chest/drawer top, best offer.

After 6 PM. 651-2823

ANTIQUES MARKET

SPRINGFIELD OAKS & DAVENBURG, Michigan County Park Blvd

APRIL 11

2nd Sunday Each Month. 175 to Dixie Hwy. N to Davisburg Rd. to 12451 Andersonville Rd. Hours 10 AM - 6 PM. Free Admission Free Parking

702 Antiques

BEAUTIFUL solid hand carved 400 year old English table, excellent condition, unusual find. Veranda. 553-3096

WE specialize in purchase and trade of used, handmade oriental rugs

Individuals, estates. Top cash prices paid. Confidential service. Anytime. DI 2-8400

ANN ARBOR - THE ANTIQUES MARKET

Sunday April 11, 1976. Ann Arbor - Saline Road, Exit 175 of I-94, 180 Dealers Antiques & Select Collectibles Guaranteed for Authenticity. FEATURING: (A-15) set of 8 half-spindle chairs original paint; arrow high chair original red paint; 7 pc bench; decorated foot stools; HEPPLEWHITE pine stand; bowback WINDSOR arm chair; quilts & coverlets. (A-18) American & English PEWTER; WINDSORS including wood chair; round top pine hutch table; 18 c stretcher base tavern table (A-32) 1 c painting man dog; snipe decors; (B-10) nice de-stoneware; (B-33) pumpkin pie; Ohio Zoar cupboard; all original grained server; pine high top desk with drawers; (B-1) fully signed TIFFANY table lamp; QUEZAL chandelier; PEACOCK HANDL lamp; puff waltz BIEDERMEIER set; sterling silver flatware, collection Maxfield PARRISH books & prints; signed Willetts Beilke's 5 pc tea set; (C-20) BASKETS - AMERICAN INDIAN, SHAKER, NANTUCKET, linens & jaces (F-4) JOHN K. DUCK, Author to autograph & discuss his new books ADVERTISING TRADE CARDS & TRANSPORTATION POSTCARDS - AM - 4 PM (COME EARLY). Admission, \$1.

FURNITURE STRIPPING WOOD & METAL HER PAL STRIP SHOP

15766 Telegraph, 2 1/2 bl N of Fenkel, Redford. 535-8115

OLD Spinning wheel \$140

Winder \$60 or trade for old dolls, or brass bed. 879-1338

703 Crafts

MEXICAN fire agates. Largest inventory. Any quality you desire. By appointment. Ask for Ken. 646-9877

704 Rummage Sales

CATHOLIC CENTRAL HIGH SCHOOL. 6665 West Outer Dr., Detroit. Rummage and Bake Sale. Saturday, April 10th, 10-3.

FRANKLIN Community Church

Franklin Village. Thursday April 9, 9 AM to 4 PM, Friday April 9, 9 AM to 12 noon.

706 Appliances

WHIRLPOOL Washer and Dryer, top of line. \$50 each. 331-3729

SEARS, Lady Kenmore deluxe

Harvest washer and gas dryer. pair \$400. Frigidaire side-by-side refrigerator. 20 cu ft. avocado, like new. \$390. Frigidaire range, set, cleaning oven, avocado. \$200. 2015 Osmus, Livonia. KE 4-2996

KELVINATOR 14 cu ft refrigerator

with bottom freezer. G.E. American stove, double oven. Maytag automatic washer, Kenmore gas dryer. KE 4-2996

22 Ft. Side-by-side refrigerator

36 inch gas range, new. Sears washer, copertone. KE 14109

REFRIGERATOR

Frigidaire, large refrigerator, good condition. Cheap 3451 Lyndon. GA 2-1146

IRONRITE, with self cover and burner best offer.

477-3453

GENERAL ELECTRIC refrigerator

10 years old, excellent condition. Best offer After 4 PM. 455-2826

FRIGIDAIRE, top freezer

White, call 421-6137

REFRIGERATOR, Colodport, ice maker

14 cu ft. \$100. 645-5235

WHITE Washer and electric dryer

Westinghouse, matching set, heavy duty, 10 months old. \$300. 326-7208

706 Appliances

TAPPAN 30 in Gas Range, harvest gold, 3 or 4 years old, excellent condition, \$110 or best offer. Call after 3 PM. 525-9209

SEARS portable dishwasher

\$100. Ward's built-in dishwasher. \$75. 476-2285

WESTINGHOUSE portable dishwasher

\$60. 464-9695

TAPPAN, white gas stove

Excellent condition. 36 inches wide. 877-1738

AUTOMATIC washer & dryer

\$50. 851-3694

WHIRLPOOL gas dryer, deluxe 3 temp.

white. \$100 or best offer. 598-6287

SEARS Kenmore gas dryer

\$55. Sears Coldspot refrigerator. \$190, in excellent condition. Must sell. \$147

REFRIGERATOR and stove

both, \$75 each. Very good. 937-9377

FRIGIDAIRE 14 Cu Ft refrigerator

Top-free, clean. \$100. 455-6118

Washer and dryer

Sears Kenmore. 525-7408

1974, heavy duty

GAS RANGE, \$35. Washer, needs repair. 522-9282

WHIRLPOOL Dishwasher, four cycle

never been used, cutting board, portable / built-in, will deliver. 585-0133

708 Household Goods Oakland County

BEAUTIFUL walnut dining room set, \$1,000. Dark oak chest of drawers, Color RCA TV. 498-2939

FURNITURE for sale

Please call after 6 PM. 398-8647

TWO matching chairs, 2 cocktail tables

swag lamp. 477-8955

SOFA by Heritage, 90"

1 year old, best offer closes to \$300. After 5:30 PM. 541-3626

BRAIDED rug and padding, 9 x 12

blue-green wool, \$50, winged back chair, light blue velvet, like new. \$150. 2d. bedspread, blue quilted. \$25. excellent condition. 646-9418

CHEST and dressing table, mahogany

Drexel. Excellent condition. 851-1773

DINETTE SET, 7 piece

\$35. Frigidaire refrigerator, \$75. Lawn spreader, \$7.50. Toy chest, \$65. 655-3074

708 Household Goods Oakland County

RED CRUSHED velvet couch, Spanish, Asking \$75. 698-4749

DINING ROOM set, cherry Duncan

Thrift, 6 chairs, china and pedestal table, excellent condition. \$175. 688-4468

GARAGE SALE

PRE-RENTED FURNITURE, MON, TUES, WED. We have a warehouse filled with 100's of pieces of furniture. Pre-rented furnishings from Model apartments. Furniture for living room, bedroom, dinette and office. Most pieces in excellent condition. Save up to 50%! All furniture sold as is. Open daily 10 AM - 6 PM.

GLOBE INTERIOR RENTALS

1100 E. MAPLE (13Mile) Troy W of I-75. 588-1800

MOVING

Must sell. Decorator furniture. Dining room Contemporary chrome and glass with 3 red chairs. \$1

710 Misc. For Sale Oakland County

CEMENT mixer Muller, with electric motor. Parker lawn sweeper. Fireplace converter grate. 353-1079

GLOBETROTTER TICKET WINNER

Anna Toth 2912 Teasdale Drive Troy, MI 48064

But you must call the Promotion Department of The Observer & Eccentric by 5:00 p.m. Tuesday, April 6, 1976, to claim your two FREE GLOBETROTTER TICKETS.

CONGRATULATIONS!

WHEELCOVERS (hub caps) all makes & sizes. Very reasonable. 851-0713

711 Misc. For Sale Wayne County

GARAGE SALE, April 9, 10, 11. Odds and ends 9 AM to 5 PM. 2602 Schoolcraft, corner of Dixie, Redford Twp.

712 Bicycles for sale

RYCYCLES. Man and woman's. Ryc. Europa. \$30 each. 332-4144

713 Business & Office Equipment

DESKS, files, swivel chairs, drafting tables, mobile plan office, typewriter, etc. 729-8756

714 Building Materials

INSULATION - CHEAP. 1,000 sq ft 3 1/2 in blanket. \$95. 1 blanket. \$15. 10 blankets. \$1,000. Free information & delivery. Smoke Detector - \$39.95. 261-5328

715 Musical Instruments

EVERETT Spinet piano and bench. Beautiful wood, excellent condition. \$275. 20015 Osmus, Livonia. 477-3749

716 Pet Service

GUINEA PIGS BABY PARAKEETS YOUNG PARROTS LOVE BIRDS COCKATIELS FINCHES SINGING CANARIES CONURES HERMIT CRABS TEDDY BEAR HAMSTERS

726 Musical Instruments

KIMBALL organ, like new. With bench. 264-7755 or 364-2111

736 Wanted to Buy

REFRIGERATOR WANTED. 933-7442

737 Household Pets

IRISH setter, AKC. 5 months, house pet, reasonable to a good home. After 5 PM. 452-2747

738 Wanted to Buy

SEA KING, 12 ft aluminum boat, complete. 7 hp motor. \$400. 421-7109

739 CB Radios

COMMUNICATION EQUIPMENT. All Major Brands. Sales-Service-Installation. 29901 Ford Rd. Garden City. 427-8851

739 Sporting Goods

ROSSI 1974, ST 650 skis and 502 Solomon bindings. Look like 500. \$175 or best offer. 626-7900

739 Building Materials

INSULATION - CHEAP. 1,000 sq ft 3 1/2 in blanket. \$95. 1 blanket. \$15. 10 blankets. \$1,000. Free information & delivery. Smoke Detector - \$39.95. 261-5328

739 Musical Instruments

EVERETT Spinet piano and bench. Beautiful wood, excellent condition. \$275. 20015 Osmus, Livonia. 477-3749

739 Pet Service

GUINEA PIGS BABY PARAKEETS YOUNG PARROTS LOVE BIRDS COCKATIELS FINCHES SINGING CANARIES CONURES HERMIT CRABS TEDDY BEAR HAMSTERS

740 Misc. For Sale Wayne County

GLASS AND SCREEN enclosed porch, aluminum, walnut. Sun console, 14x12 foot. Also stereo console, walnut wood. AM-FM tuner and Fischer turntable. 464-8853

740 Musical Instruments

CONSOLE piano, pecan wood, 1 year old. \$850. 332-6287

740 Wanted to Buy

RENT OR BUY! PA's & Mikes & Band Instruments & Amplifiers

740 Musical Instruments

STERLING UPRIGHT piano "Black". Beautiful tone. \$100 or best offer. 476-4524 or 624-4653

740 Musical Instruments

STERLING UPRIGHT piano "Black". Beautiful tone. \$100 or best offer. 476-4524 or 624-4653

740 Musical Instruments

STERLING UPRIGHT piano "Black". Beautiful tone. \$100 or best offer. 476-4524 or 624-4653

740 Musical Instruments

STERLING UPRIGHT piano "Black". Beautiful tone. \$100 or best offer. 476-4524 or 624-4653

740 Musical Instruments

STERLING UPRIGHT piano "Black". Beautiful tone. \$100 or best offer. 476-4524 or 624-4653

740 Musical Instruments

STERLING UPRIGHT piano "Black". Beautiful tone. \$100 or best offer. 476-4524 or 624-4653

740 Musical Instruments

CONSOLE piano, pecan wood, 1 year old. \$850. 332-6287

740 Musical Instruments

CONSOLE piano, pecan wood, 1 year old. \$850. 332-6287

740 Musical Instruments

CONSOLE piano, pecan wood, 1 year old. \$850. 332-6287

740 Musical Instruments

CONSOLE piano, pecan wood, 1 year old. \$850. 332-6287

740 Musical Instruments

CONSOLE piano, pecan wood, 1 year old. \$850. 332-6287

740 Musical Instruments

CONSOLE piano, pecan wood, 1 year old. \$850. 332-6287

740 Musical Instruments

CONSOLE piano, pecan wood, 1 year old. \$850. 332-6287

740 Musical Instruments

CONSOLE piano, pecan wood, 1 year old. \$850. 332-6287

740 Musical Instruments

CONSOLE piano, pecan wood, 1 year old. \$850. 332-6287

806 Boats & Motors

12 ft. Aluminum boat, oars and cushions. Excellent condition. \$125. 2015 Osmus, Livonia. 477-3749

806 Boats & Motors

SEA KING, 12 ft aluminum boat, complete. 7 hp motor. \$400. 421-7109

806 Boats & Motors

VIKING 1974, 18 ft. beautiful blue and white fiberglass, inboard - outboard, open bow, 120HP, 72 hours. E.Z. lift, trailer, extras. 728-8625

806 Boats & Motors

VIKING 1974, 18 ft. beautiful blue and white fiberglass, inboard - outboard, open bow, 120HP, 72 hours. E.Z. lift, trailer, extras. 728-8625

806 Boats & Motors

VIKING 1974, 18 ft. beautiful blue and white fiberglass, inboard - outboard, open bow, 120HP, 72 hours. E.Z. lift, trailer, extras. 728-8625

806 Boats & Motors

VIKING 1974, 18 ft. beautiful blue and white fiberglass, inboard - outboard, open bow, 120HP, 72 hours. E.Z. lift, trailer, extras. 728-8625

806 Boats & Motors

VIKING 1974, 18 ft. beautiful blue and white fiberglass, inboard - outboard, open bow, 120HP, 72 hours. E.Z. lift, trailer, extras. 728-8625

806 Boats & Motors

VIKING 1974, 18 ft. beautiful blue and white fiberglass, inboard - outboard, open bow, 120HP, 72 hours. E.Z. lift, trailer, extras. 728-8625

806 Boats & Motors

VIKING 1974, 18 ft. beautiful blue and white fiberglass, inboard - outboard, open bow, 120HP, 72 hours. E.Z. lift, trailer, extras. 728-8625

812 Motorcycles, Go-Karts-Mini Bikes

HONDA 1974 CL 350, like new. Lug, gas, rack, stissy bar. \$725. After 6 PM. 326-8980

812 Motorcycles, Go-Karts-Mini Bikes

HONDA 1970's, CB 350, like new. 6403 miles, helmets, cover. \$575. 642-1151

812 Motorcycles, Go-Karts-Mini Bikes

HONDA 1970's, CB 350, like new. 6403 miles, helmets, cover. \$575. 642-1151

812 Motorcycles, Go-Karts-Mini Bikes

HONDA 1970's, CB 350, like new. 6403 miles, helmets, cover. \$575. 642-1151

812 Motorcycles, Go-Karts-Mini Bikes

HONDA 1970's, CB 350, like new. 6403 miles, helmets, cover. \$575. 642-1151

812 Motorcycles, Go-Karts-Mini Bikes

HONDA 1970's, CB 350, like new. 6403 miles, helmets, cover. \$575. 642-1151

812 Motorcycles, Go-Karts-Mini Bikes

HONDA 1970's, CB 350, like new. 6403 miles, helmets, cover. \$575. 642-1151

812 Motorcycles, Go-Karts-Mini Bikes

HONDA 1970's, CB 350, like new. 6403 miles, helmets, cover. \$575. 642-1151

812 Motorcycles, Go-Karts-Mini Bikes

HONDA 1970's, CB 350, like new. 6403 miles, helmets, cover. \$575. 642-1151

816 Auto Parts & Service

LINCOLN Engine, 1971, 460 cid, dis. assembled. \$100. 427-2762

816 Auto Parts & Service

LINCOLN Engine, 1971, 460 cid, dis. assembled. \$100. 427-2762

816 Auto Parts & Service

LINCOLN Engine, 1971, 460 cid, dis. assembled. \$100. 427-2762

816 Auto Parts & Service

LINCOLN Engine, 1971, 460 cid, dis. assembled. \$100. 427-2762

816 Auto Parts & Service

LINCOLN Engine, 1971, 460 cid, dis. assembled. \$100. 427-2762

816 Auto Parts & Service

LINCOLN Engine, 1971, 460 cid, dis. assembled. \$100. 427-2762

816 Auto Parts & Service

LINCOLN Engine, 1971, 460 cid, dis. assembled. \$100. 427-2762

816 Auto Parts & Service

LINCOLN Engine, 1971, 460 cid, dis. assembled. \$100. 427-2762

816 Auto Parts & Service

LINCOLN Engine, 1971, 460 cid, dis. assembled. \$100. 427-2762

820 Autos Wanted

CLEAN CARS WANTED. SEE BUYER! TENNYSON CHEVROLET 32570 Plymouth Rd Livonia 425-6500

820 Autos Wanted

CLEAN CARS WANTED. SEE BUYER! TENNYSON CHEVROLET 32570 Plymouth Rd Livonia 425-6500

820 Autos Wanted

CLEAN CARS WANTED. SEE BUYER! TENNYSON CHEVROLET 32570 Plymouth Rd Livonia 425-6500

820 Autos Wanted

CLEAN CARS WANTED. SEE BUYER! TENNYSON CHEVROLET 32570 Plymouth Rd Livonia 425-6500

820 Autos Wanted

CLEAN CARS WANTED. SEE BUYER! TENNYSON CHEVROLET 32570 Plymouth Rd Livonia 425-6500

820 Autos Wanted

CLEAN CARS WANTED. SEE BUYER! TENNYSON CHEVROLET 32570 Plymouth Rd Livonia 425-6500

820 Autos Wanted

CLEAN CARS WANTED. SEE BUYER! TENNYSON CHEVROLET 32570 Plymouth Rd Livonia 425-6500

820 Autos Wanted

CLEAN CARS WANTED. SEE BUYER! TENNYSON CHEVROLET 32570 Plymouth Rd Livonia 425-6500

820 Autos Wanted

CLEAN CARS WANTED. SEE BUYER! TENNYSON CHEVROLET 32570 Plymouth Rd Livonia 425-6500

822 Trucks for sale

FORD PICK UP 1969, 6 cylinder, 3 speed. New muffler battery good condition. \$666. 334-9329

822 Trucks for sale

FORD PICK UP 1969, 6 cylinder, 3 speed. New muffler battery good condition. \$666. 334-9329

822 Trucks for sale

FORD PICK UP 1969, 6 cylinder, 3 speed. New muffler battery good condition. \$666. 334-9329

822 Trucks for sale

FORD PICK UP 1969, 6 cylinder, 3 speed. New muffler battery good condition. \$666. 334-9329

822 Trucks for sale

FORD PICK UP 1969, 6 cylinder, 3 speed. New muffler battery good condition. \$666. 334-9329

822 Trucks for sale

FORD PICK UP 1969, 6 cylinder, 3 speed. New muffler battery good condition. \$666. 334-9329

822 Trucks for sale

FORD PICK UP 1969, 6 cylinder, 3 speed. New muffler battery good condition. \$666. 334-9329

822 Trucks for sale

FORD PICK UP 1969, 6 cylinder, 3 speed. New muffler battery good condition. \$666. 334-9329

822 Trucks for sale

FORD PICK UP 1969, 6 cylinder, 3 speed. New muffler battery good condition. \$666. 334-9329

823 Vans

CHEVROLET 1975, G-20 Van, tan carpeted throughout. \$3796. Tom Holzer Ford Farmington. 474-1234

823 Vans

CHEVROLET 1975, G-20 Van, tan carpeted throughout. \$3796. Tom Holzer Ford Farmington. 474-1234

823 Vans

CHEVROLET 1975, G-20 Van, tan carpeted throughout. \$3796. Tom Holzer Ford Farmington. 474-1234

823 Vans

CHEVROLET 1975, G-20 Van, tan carpeted throughout. \$3796. Tom Holzer Ford Farmington. 474-1234

823 Vans

CHEVROLET 1975, G-20 Van, tan carpeted throughout. \$3796. Tom Holzer Ford Farmington. 474-1234

823 Vans

CHEVROLET 1975, G-20 Van, tan carpeted throughout. \$3796. Tom Holzer Ford Farmington. 474-1234

823 Vans

CHEVROLET 1975, G-20 Van, tan carpeted throughout. \$3796. Tom Holzer Ford Farmington. 474-1234

823 Vans

CHEVROLET 1975, G-20 Van, tan carpeted throughout. \$3796. Tom Holzer Ford Farmington. 474-1234

823 Vans

CHEVROLET 1975, G-20 Van, tan carpeted throughout. \$3796. Tom Holzer Ford Farmington. 474-1234

KEEP ON TRUCKIN! CHEVY VAN CUSTOMIZED VANS. See our vans on display. Sat. 10th. at Chuck Muir's Clam Digger Restaurant TOM HOLZER FORD 307 1/2 GRAND ROAD, FARMINGTON HILLS 474-1234

Pets 'N' Particulars. 22850 LAWAYNE AVE. 474-9606. Across from Farmington Plaza. Open Monday-Saturday 8 A.M. - 6 P.M. Master Charge-BankAmericard

824 Sports and Imported Cars

AUDI 1973 model 100, 4 door, 4 speed, AM-FM stereo, factory air, new tires. Excellent condition. Asking \$13,995. 646-5294

858 Cadillac

CADILLAC 1967. Runs good. \$350. 478-5831

860 Chevrolet

CHEVELLE Malibu 1975. automatic, power steering, brakes, 15,000 miles. Must sell. \$3,000. KE 2-5044

864 Dodge

CHARGER 1972. V8. vinyl top, rally wheels. air. excellent condition. 689-5506

866 Ford

PINTO 1974 wagon, power steering, air, AM-FM stereo, radial tires, good condition. \$2,250. After 5 PM. 453-5287

866 Ford

MUSTANG 1971, convertible, six, automatic, exceptionally clean, 39,000 miles. New tires, well maintained. \$1,650. 453-8291

866 Ford

TORINO 1969. 302 engine, fast-back, new tires, shocks. \$800. 522-4096

870 Jeeps & Other 4 Wheel Drive

CHEVY 1974. Pick-Up, power steering, power brakes, custom deluxe 2 tone, camper top, excellent condition, low mileage. \$3,950. Days. 453-2356, evenings. 453-4194

874 Mercury

CAPRI, 1973. 2 door. AM-FM tape, very good condition. \$1,995. O'Hara Datsun. 425-3311

852 Classic Cars

T.BIRD. 1967. 312, power steering, brakes, windows and seats. Many extra parts. \$4,000. 545-1129

DON MASSEY Cadillac

Ann Arbor Rd. at Main 453-7500 963-4512

1974 CAMARO

V-8, automatic, power, stereo, red-black & white. ASKING \$3,295

1974 MUSTANG II

Fastback radio, heater, automatic transmission, power steering, 21,000 miles. Economical 4 cylinder engine, sharp burgundy finish, rally wheels. \$2,795

1974 MUSTANG MACH I

6 cylinder, 4 speed, stereo, elec. defroster, 11,000 miles. ASKING \$2,595

1971 PINTO

2 door, radio, heater, 4 speed transmission, white sidewall tires, low miles, bright red finish, real economy. Our low price. \$1,095

1973 CHEVROLET

Cheyenne, V-8, automatic, power steering, power radial tires, blue with black top. Sharp! ASKING \$3,595

876 Oldsmobile

CUTLASS 1973. Supreme extra color one owner, good color, 4 equipment. Monday special \$3,995. Art Moran Pontiac 29300 Telegraph, Southfield. 353-9000

854 American Motors

GREMLIN X. 1974. air, AM-FM stereo, 3 speed, good condition. \$1,800. Call after 6 PM. 437-9245

1976 VEGA

2 door, automatic transmission, radio, whitewall tires, 440 miles. Only \$2,995

862 Chrysler

IMPERIAL 1966. 4 door, automatic, full power, good for high school student. After 10 AM. 425-1433

864 Dodge

COLT 1973. 2 door, 4 speed on the floor, low mileage. \$1,875. 455-4548

1971 MAVERICK

4 door sedan, radio, heater, automatic transmission, power, V-8 engine, white sidewall tires, real sharp light green finish. Much transportation for only \$1,290

1974 GRAN TORINO

9 passenger Squire station wagon, power steering and brakes, factory air conditioning, mint condition. \$3,495

1976 PINTO

Stallion, automatic transmission, radio, heater, 2,000 miles, your present car will make the down payment. New car bank pays. \$3,095.

76 LINCOLN COUPE

Full factory equipment, vinyl roof, AM/FM stereo radio. \$211.78 month

76 COUGAR XR7

Full factory equipment, air conditioning, radio, white walls. \$139.25 month

GLOBETROTTER TICKET WINNER

Edward J. Marek 9639 Norborne Detroit, MI 48229

CONGRATULATIONS!

PACER X. 1975. AM-FM stereo, power steering, air, luggage rack, radial snow tires. \$3,000. After 4 PM. 478-2628

1973 CHARGER

2 door hardtop, automatic transmission, radio, heater, whitewalls. \$1,795

864 Dodge

DART 1971. Swinger. 2 door hardtop, air, power steering, power brakes, vinyl roof, sharp inside and out. \$1,295. Town & Country Dodge. 474-6688

1974 MUSTANG II

4 door, copper with matching top and interior, automatic, air, radio, 10,000 miles. ASKING \$4,195

1974 GRAN TORINO

9 passenger Squire station wagon, power steering and brakes, factory air conditioning, mint condition. \$3,495

76 MONARCH

Automatic, radio, whitewalls. \$118.99 month

76 MARK IV

AM/FM stereo radio, vinyl roof, leather interior, tilt and cruise. \$234.44 month

1972 GREMLIN

2 door, radio, heater, whitewalls, economy special, \$1,195.

1975 CHEVETTE

V-8, automatic, air, 5,800 miles, copper, very sharp. ASKING \$3,495

1975 CHEVETTE

V-8, automatic, air, 5,800 miles, copper, very sharp. ASKING \$3,495

1975 CHEVETTE

V-8, automatic, air, 5,800 miles, copper, very sharp. ASKING \$3,495

1975 CHEVETTE

V-8, automatic, air, 5,800 miles, copper, very sharp. ASKING \$3,495

1975 CHEVETTE

V-8, automatic, air, 5,800 miles, copper, very sharp. ASKING \$3,495

1975 CHEVETTE

V-8, automatic, air, 5,800 miles, copper, very sharp. ASKING \$3,495

1975 CHEVETTE

V-8, automatic, air, 5,800 miles, copper, very sharp. ASKING \$3,495

1975 CHEVETTE

V-8, automatic, air, 5,800 miles, copper, very sharp. ASKING \$3,495

NOBODY IN THE WORLD SELLS MORE AMERICAN MOTORS CARS THAN GREENFIELD AMC/JEEP

BUY DIRECT AND SAVE

GO RIVER

SCHOOLCRAFT

GREENFIELD

GREENFIELD

20255 GRAND RIVER

BUY DIRECT AND SAVE

WORLD'S LARGEST AMERICAN MOTORS DEALER

GREENFIELD AMC/JEEP THE AMERICAN MOTORS KING SAYS: 'I don't care where you've been or what you've been offered on any car - don't sign any order with any dealer until you see our deal!'

MULLIGAN LINCOLN-MERCURY 20200 GRAND RIVER KE 2-4000 ANNOUNCING RED CARPET LEASING

GAS SAVER COMPANY CARS 1976 BUICK SKYLARK - V-6, 2 & 4 DOORS

THINK SPRING GUARANTEED USED CARS 1970 NOVA \$695 1972 CADILLAC COUPE DeVILLE \$3,088

STU EVANS SELLS FOR LESS GET OUR DEAL BEFORE YOU BUY

STU EVANS MERCURY LINCOLN LIMITED EDITION 1976 MERCURY COUGAR XR-7

DEAL OF THE WEEK 1976 COUGAR XR7 \$4,417

STU EVANS 32000 FORD RD. (near Merriman) GARDEN CITY 425-4300

BET YOU DIDN'T KNOW... 1. We were rated #1 in service by Pontiac Motor Division... BOB SELLERS PONTIAC

Hines Park 40601 Ann Arbor Rd. Plymouth 453-2424

# Ford sells CB radios

A full line of citizen's-band two-way radios and accessories soon will be available through Ford and Lincoln-Mercury dealers.

CB equipment manufactured by the E. F. Johnson Co. is being distributed by participating Ford Motor Co. dealers.

Johnson, one of the largest manufacturers of CB equipment in the world, assembles all but one of its products in the United States.

"Ford is pleased to offer this high quality CB radio equipment through our dealerships," a Ford spokesman said. "Today, nearly everywhere you look, you see someone using citizen's-band radios. Already, one out of every 21 automobiles on the road has CB."

Johnson offers a limited one-year parts and labor warranty on all equipment, and has more than 800 authorized service centers nationwide.

BESIDES AUTOMOTIVE applications, CB radios are used by farmers and businessmen for low-cost two-way communications with their offices, homes, work vehicles and men in the field.

Truckers, who have been instrumental in the popularity of CB, use it to keep informed on highway conditions ahead. Campers, boaters and sportsmen like the safety of being able to stay in touch anywhere outdoors.

More than 25 per cent of all motorhomes now are equipped with CB. Volunteer groups across the country answer scores of calls daily on Emergency Channel 9 as a public service. Hundreds of thousands of families use it for everyday communications from car to home.

FCC licenses are easy to obtain and no test for technical knowledge is required.

Many motorists are adding citizen's band (CB) radios to their cars and trucks to keep them in touch with other CB'ers for both routine and emergency communications. CB users have developed a language all their own for keeping fellow motorists posted on highway conditions, requesting emergency assistance and for other important communications. Here's a list of popular CB terms. How many can you de-code? (See answers below.)

## CB quiz

1. Antennas for CB radios. 2. Truck weighing station. 3. Traffic control radar. 4. Message received, the answer's yes. 5. Truck transporting cars. 6. Truck with 18 wheels. 7. Trucks in long caravan. (Lead truck is "front door," last truck is "back door.") 8. What's your location? (Often expressed as highway mile post.) 9. Female driver or passenger. 10. CB transceiver. 11. Nickname CBER will use in addition to call letters. 12. Lead driver or first in a convoy.

1. Ears
2. Chicken coop
3. Shotgun
4. That's a copy
5. Portable parking lot
6. 18 wheeler
7. Rocking chair
8. What's your 20?
9. Seat covers
10. Rig
11. Handle
12. Front door

## Auto refresher

Refresher courses on tune-up procedures and emission-control systems are being offered to vocational automotive instructors this summer. Ford Motor is sponsoring the series of workshops.

From June 14 to July 30, at least one 40-hour workshop will be conducted by Ford service engineers at each of the division's 31 nationwide training locations. Up to 18 voca-

tional instructors will be accepted for each class.

"We intend to make these summer workshops an annual offering," said Philip E. Benton Jr., division general manager. "This year, the course will supply automotive vocational teachers the latest in tune-up techniques and up-to-date emissions-control information."

A letter had been sent to state vocational directors advising them of the program.

### 880 Pontiac

BONNEVILLE 1973, power steering, brakes, air, AM-FM stereo, vinyl top, 2 door, rustproof, 22,000 miles, private. 477-7340

PONTIAC CATALINA 1970, excellent condition, \$1100, one driver, power brakes, steering, air, automatic, MA 0272

TRANS AM 1976, silver, many extras, \$6,000 After 5 PM. 538-2363

GTO, 1968, power brakes, steering, tilt steering, air, new battery, good condition, best offer. 851-3216

GRAND PRIX 1975, White and black, air, stereo, windows, locks, tilt, radials, more Spottless, make offer. 558-6158

FIREBIRD, Esprit, 1976, Automatic, loaded, Excellent condition 4000 miles, \$4950 After 6PM. 852-5681

GRAND SAFARI, Pontiac 1973, station wagon, 9 passenger, air, stereo, loaded, \$1795. 352-0300, ext. 34

GRAND AM 1973, Low miles, Gas economy, Air, stereo, full power, Very clean, \$2,700. 565-2556

CATALINA 1971, 2 door, hardtop, Air, power, 1 Owner, 41,000 actual miles, \$850. 464-8787

GRAND LE MANS 1975, 4 door, vinyl top, burgundy, many options, 12,000 miles, Excellent condition, \$4,175. 464-8720

GRANDVILLE, 1973, 4 door, power steering, brakes, windows, seat, AM-FM, air, \$2250. 421-7987

PONTIAC 1964, excellent running condition, \$125. 459-0292

BONNEVILLE 1973, 4 door, air tinted glass, many extras, Florida car, Excellent condition, Low mileage, \$2500. 356-1822

GRAND AM 1973, 4 speed, reclining buckets, AM-FM, power, mag wheels, 28,000 miles, Best offer, After 4 PM. 937-1172

GRAND PRIX 1970, Power steering, power brakes, power windows, air, Good condition, \$1,250. 355-5948

FIREBIRD, 1972, 350 auto, power brakes, steering, Clean. 879-8645

PONTIAC CONVERTIBLE, 1971, Good condition, 70,000 miles, very good tires, air conditioning, \$1,900. 532-7824

### 880 Pontiac

LeMANS 1974, power steering, power brakes, air, vinyl top, radials, buckets, excellent, 28,000 miles. 455-3348

LeMANS 1970, 2 door, hardtop, radio, tape, new brakes, new exhaust system, good condition. 642-0665

ASTRE 1975, Safari wagon, 4 speed, low mileage, mint condition. 525-3828

CATALINA, 1973, 4 door, hardtop, sharp, low mileage, air conditioning, new tires, \$1895 Call after 4 PM. 525-4423

CATALINA, 1973, 4 door, power brakes - steering, air, radio, very clean, Extras \$1,900. 421-3335

CATALINA 1973, 4 door, vinyl roof, air, power steering, low mileage, \$1800, After 6PM. 464-8503

### 882 Thunderbird

THUNDERBIRD, 1973, loaded, 5 to choose from, Reasonable, Avis Ford. 354-3100

THUNDERBIRD, 1973, burgundy with black roof, leather interior, loaded, 39,700 miles, \$3,795 Tom Holzer Ford, Farmington 474-1234

T-BIRD, 1967, 2 door hardtop, full power, and factory air, yellow with brown top and interior, Very nice car for only \$875, Topp. 555-6100

THUNDERBIRD, 1965, Real sharp car. For only \$400 or best offer. 524-7818

T-BIRD, 1975, full power, green, white vinyl top, white leather interior, AM-FM stereo, tilt wheel, cruise control, electric defrost, other extras, \$6,295. 478-0387

THUNDERBIRD 1974, triple black, AM-FM stereo, air, power windows, 23,000 miles, excellent condition, \$4650 After 6 PM. 455-2855

### 884 Volkswagen

VOLKSWAGEN 1970, Red, good condition. 538-0948

FASTBACK, 1969, runs well, good condition, tuned, new clutch, battery, starter, generator, muffler, \$495. 624-8937

BEETLE 1974, 16,000 miles Sharp, \$2,495. Call after 6 PM. 427-2596

### 884 Volkswagen

VW 1966, runs good, \$150. 652-9596

1974 VW Sedan, automatic transmission, AM radio, 16,000 miles, Excellent condition, \$2,795.

TOM SULLIVAN VOLKSWAGEN 25400 W 8 Mile 353-4900

KARMANN GHIA 1964, New starter, battery 30mpg, \$300 OLDS 98, 1964, Loaded, Mint, \$500 424-5378

### 884 Volkswagen

SUPER BUG 1974, AM-FM 8 track, Stereo, Rear window defogger, Spare snow tires, New front and rear independent suspension, extras \$2,700. 427-5725

63 VW Sedan \$295  
69 VW Sedan \$790  
70 VW Sedan, auto \$995  
71 Super Beetle \$1,295  
74 Fiat \$2,495  
74 Toyota Wagon \$2,495

TOM SULLIVAN VOLKSWAGEN 25400 W 8 Mile 353-4900

### 884 Volkswagen

SQUAREBACK, 1970, automatic, am-fm stereo, good mechanical condition. 477-1921

VW 1968, Beetle, rebuilt engine, best offer. 478-4791

VW 1967, Sunroof, original owner, excellent mechanical condition, little rust, radio, gas heater, \$550. 464-2986

VW KARMANN-GHIA 1974, mint condition, Ziebarted, 9800 miles, AM-FM, mounted snow tires, \$2800, After 7 PM. 641-8760

**USED CAR BONANZA**  
50 SHARP CARS TO CHOOSE FROM

'76 VOLARE \$3,031	'76 CORDOBA \$4,623
'76 ARROW \$3,175	'76 FURY \$3,196
'76 CHRYSLER N.Y. \$5,346	'75 VALIANT 4 dr. \$2,977

**Dom Marino's COLONY**  
CHRYSLER Plymouth

**YOU CAN TRUST**  
111 ANN ARBOR RD. (M-14 & Lilley)  
WEST OF NEWBURGH RD. PLYMOUTH  
453-2155

**RENTALS**  
DAILY-WEEKLY-MONTHLY  
WO 2-3830

**STU EVANS**  
SELLS FOR LESS

GET OUR DEAL BEFORE YOU BUY

- MERCURY
- LINCOLN
- CADILLAC
- CAPRI
- MONARCH
- MARK IV
- COMET
- BOBCAT
- MONTEGO

LARGE INVENTORY

**STU EVANS**  
32000 FORD ROAD (near Merriman)  
GARDEN CITY 425-4300

1974 MUSTANG 2 door, radio, heater, 4 speed, white walls, economy car. \$2,095	1971 CORVETTE 4 speed, radio, heater, white wall tires, T-top. \$3,895
1972 OPEL G.T. Orange with black trim, 4 speed, SHARP. \$2,095	1975 PONTIAC BONNEVILLE 3 way white, 2 door, power steering, power brakes, AM/FM radio. Less than 6,000 miles. Sharp. \$3,785
1971 FORD COUNTRY SQUIRE WAGON Radio, heater, automatic, power steering, power brakes, white walls, luggage rack, air conditioning. \$995	1975 MERCURY COLONY PARK WAGON 10 passenger, radio, heater, automatic, factory air conditioning, luggage rack, white walls, power windows, power steering, power brakes. \$4,995
1973 CAPRIS Radio, heater, 4 speed, white wall tires. From \$2,095	1972 PINTO RUNABOUT Radio, heater, automatic transmission, white wall tires. Sharp! \$1,395
1973 MERCURY MARQUIS BROUGHAM Full power, air conditioning, AM/FM stereo, special control, tinted glass, vinyl top, electric rear defroster, power door locks, white wall tires. \$2,995	1974 THUNDERBIRDS Automatic transmission, radio, heater, power steering, power brakes, factory air conditioning, Landau top. From \$4,995
1974 CADILLAC COUPE DeVILLE Full power, factory air conditioning, white walls, vinyl top, SHARP. \$5,295	1972 CHEVROLET MALIBU 2 door, hardtop, radio, heater, automatic transmission, white wall tires, power steering, power brakes. Really a good buy! \$1,695

**\$ SAVE \$ MORE THAN \$100<sup>00</sup>**

**LEO CALHOUN**  
453-1100 41001 PLYMOUTH RD. "Where Customers Bring Their Friends"

**EARLY SPRING SPECIAL BUYS**

★5 speed or automatic transmission at no extra charge on Sunbirds & Astres ordered prior to April 30th, 1976.

LARGE SELECTION OF: ordered as low as:

SUNBIRDS .... \$3,137<sup>00</sup>  
ASTRES ..... \$2,817<sup>00</sup>  
GRAND PRIX .. \$4,143<sup>00</sup>

**BRUCE CRAIG PONTIAC**  
877 Ann Arbor Rd. Plymouth 453-2500

**876 Oldsmobile**  
OLDS 1972, Delta 88 automatic, power steering, power brakes, air conditioning, AM-FM stereo. \$1875. 459-2221

**876 Oldsmobile**  
OLDS 98 1968, Full power, clean inside & out, runs good, \$550 or best offer. After 5 PM. 355-2786

**878 Plymouth**  
BARRACUDA, 1970, great condition, 3 speed, slanted 6, best offer. 852-4626

**878 Plymouth**  
SPORT SUBURBAN BROUGHAM, 1973, 9 passenger, stereo, air, loaded, New radials, battery. Excellent. \$2200. 352-5628

**BRAND NEW 1976 CHEVETTE**

Cream colored Scooter includes 1.4 litre engine, 4 speed transmission, Special buckskin interior and prep. \$2,725 (plus freight & taxes)

**Leo LaRiche CHEVROLET**  
40875 Plymouth Rd. Plymouth 453-4600 (Across from Burroughs)

**\$50 MORE FOR YOUR TRADE-IN DURING OUR 1st ANNIVERSARY THE ENTIRE MONTH OF APRIL**

**YOU MUST BRING THIS AD!**

**ROLLIE BARRETT**  
CHRYSLER-PLYMOUTH  
30777 PLYMOUTH ROAD, LIVONIA, 525-5000

**ACTION OLDS VALUE RATED USED CARS**

1974 CAMARO Z-28 V-8 automatic transmission, power steering, power brakes, new car trade, low mileage. \$3,895	1974 & 75 CUTLASS SUPREMES Air conditioning, full power, 8 to choose from. From \$3,895
1975 MONTE CARLO V-8 automatic transmission, power steering, power brakes, landau top, AM/FM stereo radio, factory air conditioning, low mileage, new car trade. \$4,695	1973 OLDS 98 LUXURY SEDAN COUPE Power steering, power brakes, power windows, power seats, AM/FM stereo radio, factory air conditioning, new car trade. \$3,195
1975 CAMARO Automatic transmission, power steering, power brakes, low mileage, new car trade. \$3,695	1975 FORD 1/2 TON PICKUP F-100 RANGER V-8 automatic transmission, power steering, power brakes, priced to sell. \$3,995

**ACTION OLDS LIVONIA, MICH.**  
33850 Plymouth Road, Livonia 261-6900 (One block west of Farmington Road)

**BOB SAKS OLDSMOBILE Value Rated 125 USED CARS TO CHOOSE FROM**

1975 CUTLASS Supreme 2 door, hardtop, automatic transmission, power steering and brakes, vinyl roof, air conditioning, radio, white wall tires, extra sharp, SPECIAL. \$4,188	1974 PONTIAC Lemans Safari, 9 passenger wagon, automatic transmission, full power including windows and door locks, air conditioning, stereo. \$3,888
1975 OMEGA BY OLDS Hatchback Sport Coupe, 6 cylinder, automatic transmission, power steering, power brakes, radial tires, showroom new. \$2,995	1975 LINCOLN Town Coupe, leather, loaded with every option available, like showroom new. \$7,995
1974 BUICK CENTURY REGAL SPORT COUPE V-8 automatic transmission, power steering, power brakes, AM/FM stereo radio, vinyl roof, factory air conditioning, very low mileage. \$3,895	1973 OLDS 98 Luxury Coupe, Fully loaded with all factory equipment, vinyl roof, AM/FM stereo radio, includes air conditioning, Summer ready. \$3,188
1974 VOLVO 4 DOOR-164E Loaded, automatic transmission, air conditioning, exceptionally sharp. \$4,988	1975 CORVETTE T-coupe, air conditioning, automatic transmission, 360 engine, power windows, AM/FM radio, tilt wheel, fire red, like new. \$7,795
1975 CUTLASS 9 passenger wagon, automatic transmission, full power, factory air conditioning, radio, white wall tires, only 13,000 miles, showroom new. \$4,595	1974 FIREBIRD Console automatic transmission, buckets, power windows, 16,000 guaranteed miles, like showroom new. \$3,490
1974 BUICK ESTATE Station Wagon, 9 passenger, automatic transmission, full power including windows, seats and door locks, stereo radio. \$4,195	1974 TORONADO Brougham, loaded, AM/FM, stereo radio, think spring 2 to choose from. \$3,688
1974 MAVERICK Custom 4 door, gas saver, V-8, automatic transmission, power steering and brakes, factory air conditioning. \$2,695	1974 LINCOLN Continental, 4 door luxury, loaded with full factory equipment, plus AM/FM stereo radio and sunroof, super low mileage, showroom new. \$5,388
1972 CAPRICE V-8 automatic transmission, power steering and brakes, factory air conditioning, AM/FM radio, vinyl roof, showroom new. \$2,195	1975 DODGE Ramcharger, 4 wheel drive, V-8 automatic transmission, power steering, power brakes, radio, buckets with ice chest console, plus rear seat, only 7,000 miles. Like new. \$5,195
1973 MONTE CARLO Sport Coupe, V-8 automatic transmission, power steering and brakes, air conditioning, vinyl roof, AM/FM radio. One owner, Super low mileage. \$3,395	1974 CHEVROLET SUPER CHEYENNE SUBURBAN 4 wheel drive, automatic transmission, power steering, power brakes, AM/FM stereo radio, double air conditioning, summer ready. \$5,795

"ASK ABOUT OUR 100% 12 MO. - 12,000 MILE USED CAR POWER TRAIN WARRANTY"  
AT GRAND RIVER AND DRAKE 478-0500 JUST 2 MILES WEST OF FARMINGTON

# MEIJER 1-STOP SHOPPING GUIDE

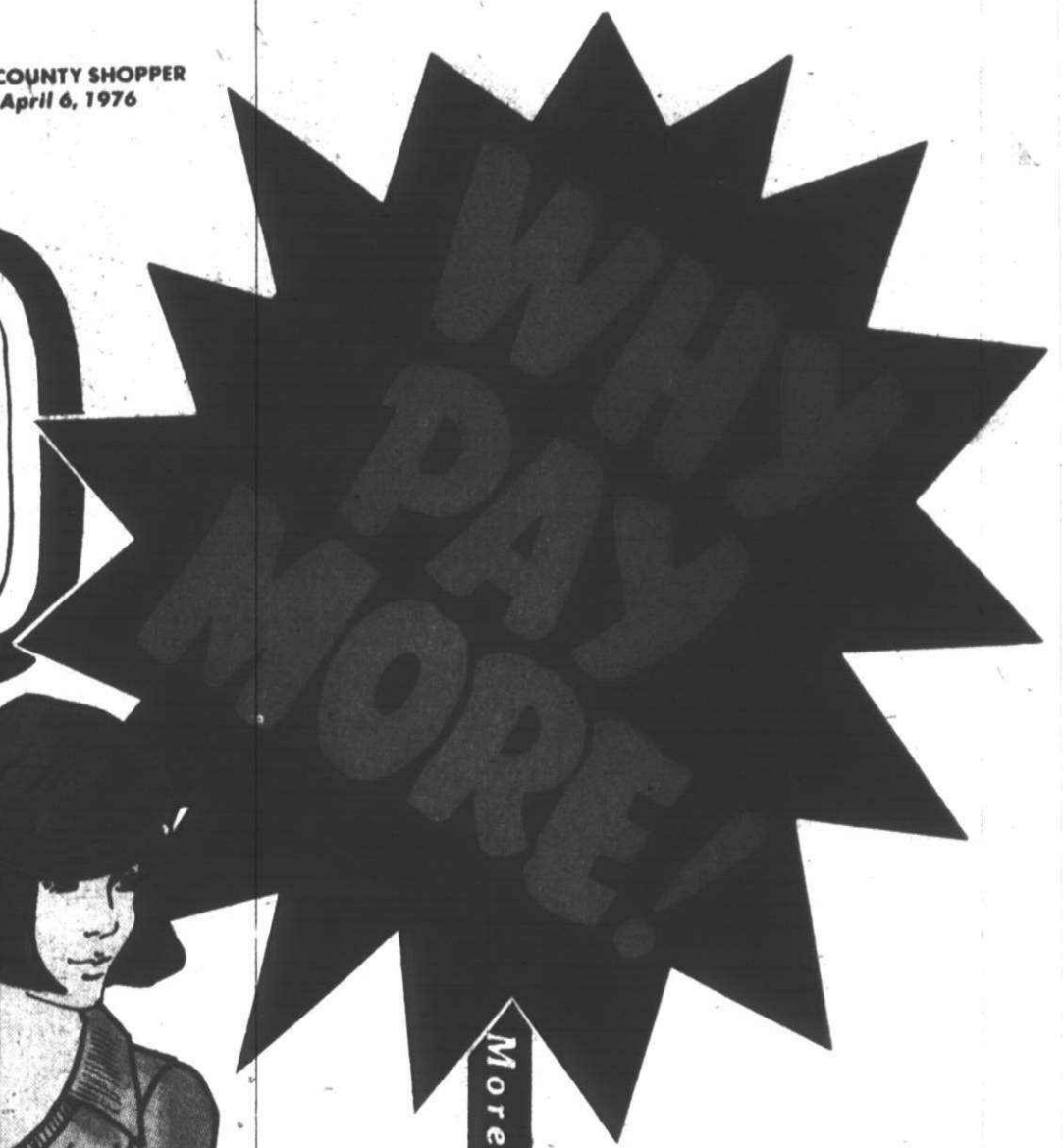

Why Pay More! Why Pay More! Why Pay More! Why Pay More! Why Pay More! Why Pay More! Why Pay More! Why Pay More! Why Pay More! Why Pay More!

More! Why Pay More! Why Pay More! Why Pay More! Why Pay More! Why Pay More! Why Pay More! Why Pay More! Why Pay More! Why Pay More!



**"TIME FOR SWEATERS"**  
Ladies' short sleeve pullovers take the fashion spotlight for Spring. Here, in a charming choice of styles to wear on their own or layered for greater versatility. Assorted spring colors in sizes small, medium, and large.  
**\$5.58 EA.**  
THIS ITEM IS ONLY AVAILABLE IN MEIJER BUCKLE MARKETS.

**"EASTER SPECIAL"**  
**LADIES' MIX AND MATCH GROUP**  
• Assorted Spring colors in sizes 8 to 16.  
**LONG SLEEVE BLOUSES** \$8.27 EA.  
• Assorted prints.  
**BELTED SKIRT** \$7.58 EA.  
• 100% polyester  
**BELTED PANTS** \$9.58 PR. AND \$10.58 PR.  
• Two styles  
• 100% polyester  
Ladies' Dept.

**SKIRTS**  
**\$7.58 EA.**

**BLOUSES**  
**\$8.27 EA.**

**Why Pay More!**

**SLACKS**  
**\$9.58 PR. & \$10.58 PR.**

In the News & Views Dept.

**NAEYC PROCLAIMS WEEK OF THE YOUNG CHILD**

THE NATIONAL ASSOCIATION FOR THE EDUCATION OF YOUNG CHILDREN has proclaimed April 4-10 as THE WEEK OF THE YOUNG CHILD. The purpose of the week is to emphasize the rights, needs and well-being of all young children, especially those of pre-school age.

**TRADITIONALLY-PARENTS,** particularly mothers, have been able to provide care for their children. But, during the past few years, many women have joined the job force. They now find it necessary to depend on others to provide adequate day care for their children.

THE NAEYC points out that these children need more than a babysitting service. They need loving care and enriching experiences. With special emphasis during THE WEEK OF THE YOUNG CHILD, the NAEYC attempts to help parents obtain the proper care for their children.

A GOOD DAY CARE CENTER provides needed care, protection and continuous developmental, educational experiences while children are away from their parents.

THE NAEYC suggests several things to keep in mind when choosing a day care program for your child.

- (1) Do the children have plenty of space in which to play? Is outdoor play possible, especially during warm weather?
- (2) Is the building a safe, sanitary, healthy place?
- (3) Is the time organized and are routines established?
- (4) Are proper play materials and equipment available? Toys such as puzzles for problem solving should be provided. Large pieces of apparatus such as balancing boards, boxes, etc. should be available for active play.
- (5) Does the day care center establish a rapport with parents? Are comments welcomed and progress reports given?
- (6) Do the adults involved in the child care programs show warmth, friendliness, and understanding?

WE AT MEIJER wish the NAEYC success during THE WEEK OF THE YOUNG CHILD. We realize how important it is that young children receive the proper care during their formative years.



PRICES GOOD MONDAY APRIL 5 THRU SATURDAY APRIL 10, 1976.

MEIJER RESERVES THE RIGHT TO LIMIT SALES ACCORDING TO SPECIFIED LIMITS.

CHARGE ANYTHING IN THE STORE EXCEPT FOOD, LIQUOR AND SUPERMARKET ITEMS

4-5-6



**YOU DON'T NEED CASH! USE EITHER OF THESE CONVENIENT CREDIT CARDS!**



Why Pay More! Why Pay More! Why Pay More! Why Pay More! Why Pay More! Why Pay More! Why Pay More! Why Pay More! Why Pay More! Why Pay More!



**LADIES' NYLON SHIFT GOWNS**

With embroidery and ric rack trim. Sizes S-M-L. White only. Special purchase!

**\$5<sup>97</sup>**

**LADIES' SHORT SLEEPCOAT**

Nylon with button front, embroidery and ric rack trim. Sizes S-M-L. White only. Special purchase!

**\$8<sup>97</sup>**

**LADIES' LONG NYLON GOWNS**

With embroidery and ric rack trim. Sizes S-M-L. White only. Special purchase!

**\$6<sup>97</sup>**

Ladies' Dept.



**LITTLE GIRLS' SPRINGTIME DRESSES**

Pretty pastels in easy-care double knit polyesters. Sizes 2T-4T and 4-6X

**\$3<sup>88</sup>**

AFTER AD \$4.97

Girls' Dept.



TOPS \$1<sup>44</sup>

JEANS \$2<sup>44</sup>

**GIRLS' JEANS & KNIT TOPS**

Jeans with 1/2 elastic waist with snap front. Fanc short sleeve knit tops of easy care 50% polyester/50% cotton.

TOPS \$1<sup>44</sup> JEANS \$2<sup>44</sup> pr.

Girls' Dept.

**GIRLS' NYLON JACKETS**

Fully flannel lined for warmth. Hooded, drawstring waist. Choose from solid or multi-tone fashion looks.

SIZES 4-6X AFTER AD \$4.17 SIZES 7-14 AFTER AD \$4.97 **\$3<sup>44</sup> \$3<sup>88</sup>**

Girls' Dept.

Why Pay More!



Why Pay More!

**Special Purchase! MAKE YOURSELF A SPRING WARDROBE**

Buy more than one of these three piece pantsuits and interchange the pieces. Make a multitude of outfits. Each pantsuit has a long sleeve jac, sleeveless tank and pull-on slacks. All washable polyester. Brilliant pastel shades of blue, green, peach and maize. Misses sizes. White special purchase lasts!

**\$16<sup>57</sup>** 3 PIECE SET

Ladies' Dept.

**LADIES' RAIN SLICKERS**

- Duck Bill hood with snap front patch pockets
- Assorted colors
- Sizes S-M-L

OUR REG. \$6.97

**\$5<sup>66</sup>**

**LADIES' CASUAL LEATHER-LIKE VINYL HANDBAGS**

• Assorted styles

Ladies' Dept.

**\$3<sup>94</sup>**

OUR REG. \$4.97 Save \$1.03

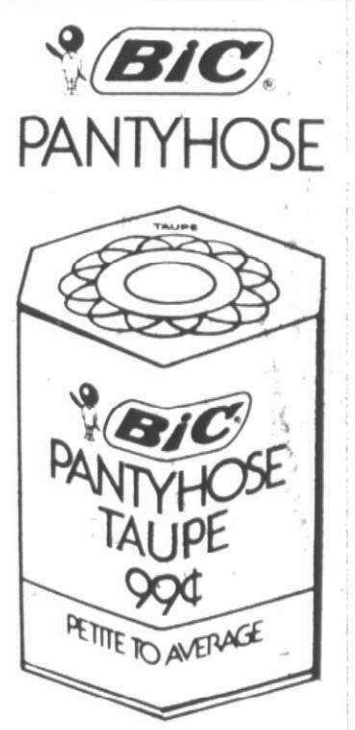
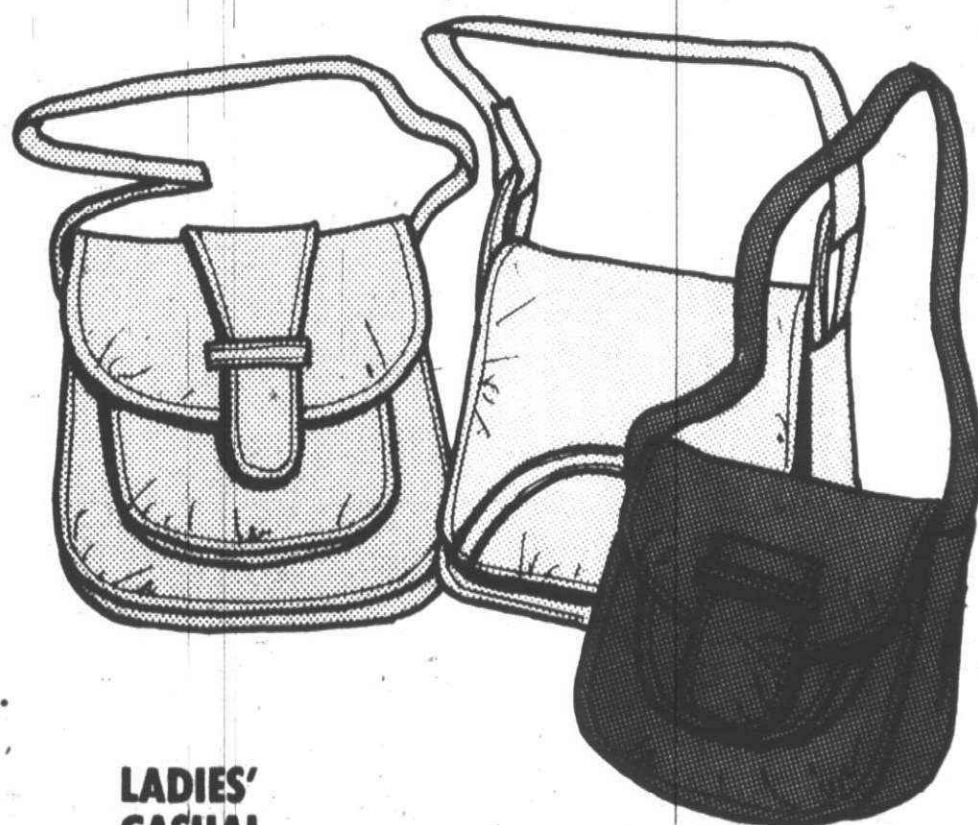

GREAT LOOKING, GREAT FITTING, YOU CAN WEAR THEM EVERYDAY.

- Petite to Average
- Average to Tall
- Assorted fashion shades

OUR REG. 79¢

**69¢** pr.

Ladies' Dept.



Why Pay More!

**m** in the shoe department

Why Pay More!

Why Pay More!

Why Pay More!



**\$200 OFF WITH COUPON**

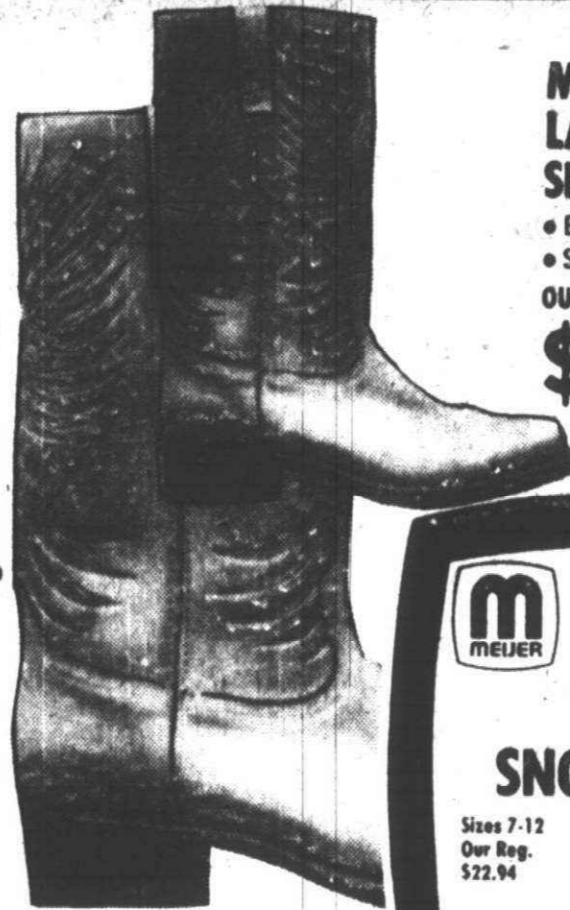

**MEN'S HAND STAINED LATIGO COWHIDE FOOT SNOOT BOOTS**

• Eagle embossing on vinyl tops  
• Sizes 7 to 12.  
OUR REG. \$22.94

**\$20<sup>94</sup> pr.**  
WITH COUPON

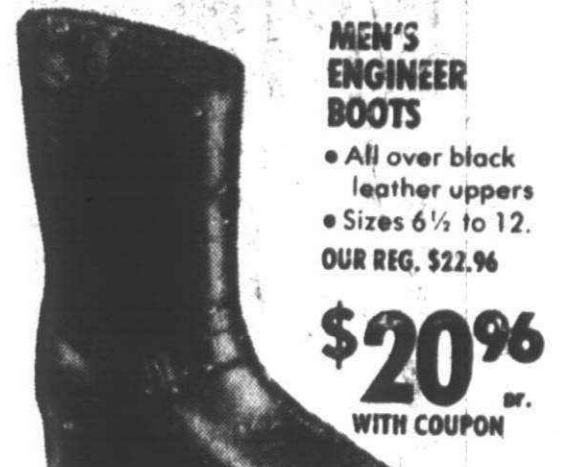

**MEN'S ENGINEER BOOTS**

• All over black leather uppers  
• Sizes 6 1/2 to 12.  
OUR REG. \$22.96

**\$20<sup>96</sup> pr.**  
WITH COUPON



**MEN'S 12" SNOOT BOOTS**

Tan driftwood cowhide foot and top. Boar snoot toe and western heel. Sizes 7-12.

OUR REG. \$24.94

**\$22<sup>94</sup> pr.**  
WITH COUPON



**MEN'S HARNESS BOOTS**

Brandy stained leather foot with matching vinyl top. Boar snoot toe, leather harness strap. Sizes 7-12.

OUR REG. \$23.94

**\$21<sup>94</sup> pr.**  
WITH COUPON



**MEN'S DESERT BOOT**

All over tan suede leather uppers in sizes 6 1/2 to 12.

OUR REG. \$15.96

**\$13<sup>96</sup> pr.**  
WITH COUPON



**MEN'S WELLINGTON BOOTS**

All over black leather uppers in sizes 6 1/2 to 12.

OUR REG. \$24.96

**\$22<sup>96</sup> pr.**  
WITH COUPON

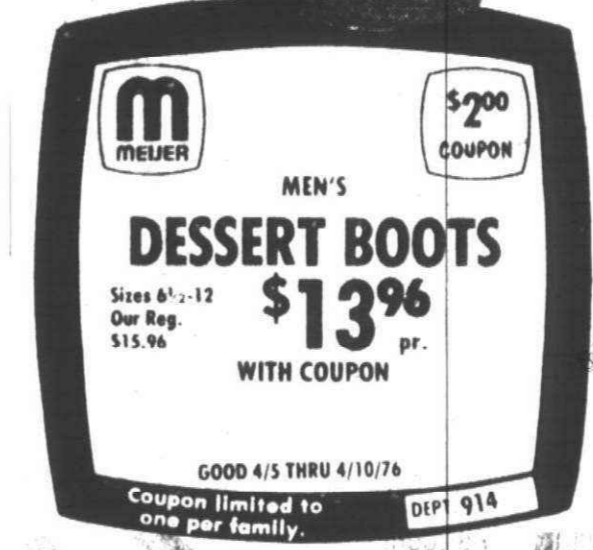
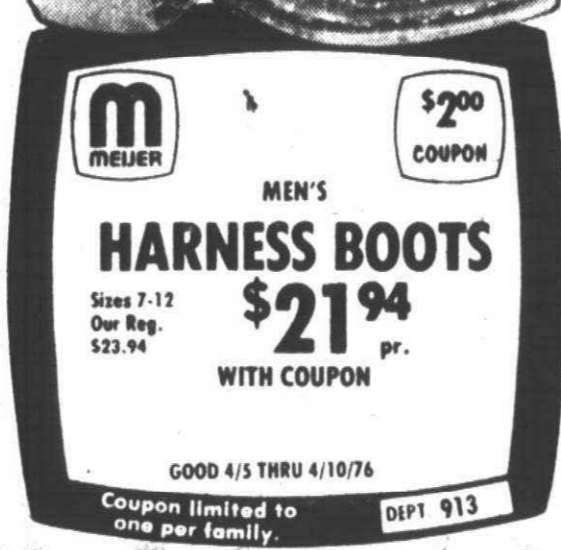

**m** in the pharmacy department

PRICES MAY VARY IF THE QUANTITY IS OTHER THAN WHAT IS ADVERTISED



**GENERIC DRUGS NOW AT "WHY PAY MORE" PRICES**

We stock generic drugs manufactured or distributed by well known companies. Pfizer, Parke Davis, Lederle, Burroughs-Wellcome, and Purepac are just a few. If you have any questions about generics feel free to ask one of our Pharmacists.

**PENICILLIN G, POTASSIUM 400,000 UNITS**  
• 30 tablets **79¢**

**ERYTHROMYCIN STEARATE 250 MG.**  
• 30 tablets **\$2.50**

**PENICILLIN VK SUSPENSION 250 MG.**  
• 100 cc **\$1.99**

**AMPICILLIN 250 MG. CAPSULES**  
• 30 capsules **\$1.99**

**HYDROCHLOROTHIAZIDE 50 MG.**  
• 100 tablets **\$2.99**

**THYROID TABLETS 1 GR.**  
• 100 tablets **69¢**

**QUINIDINE SUFLATE 3 GR.**  
• 100 tablets **\$9.40**

**PENICILLIN VK, POTASSIUM 250 MG.**  
• 100 tablets **\$4.99**

**PREDNISONE 5 MG.**  
• 100 tablets **\$1.99**

**PAPAVERINE HCL. T.D. 150 MG.**  
• 100 capsules **\$3.99**

ABOVE ITEMS ARE AVAIL. ONLY WITH A PRESCRIPTION

PHARMACY PRICES GOOD THRU APR. 17, 1976

**FLETCHER'S CASTORIA**  
2.5 fl. oz. Natural laxative specially made for children. Regular.

**69¢**

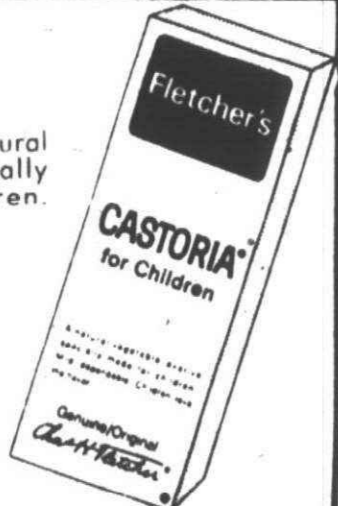

**NORELCO HEAT LAMP**

• Red heat lamp  
• Model FY51  
OUR REG. \$5.29

**\$4.49**



**UNWAXED DENTAL FLOSS**  
• 200 yards. **99¢**



**PHILLIP'S MILK OF MAGNESIA**  
• Fast antacid relief  
• 100 tablets **99¢**



**WETTING SOLUTION**  
• For hard contact lenses  
• 2 fl. oz. **\$1.39**

photo department

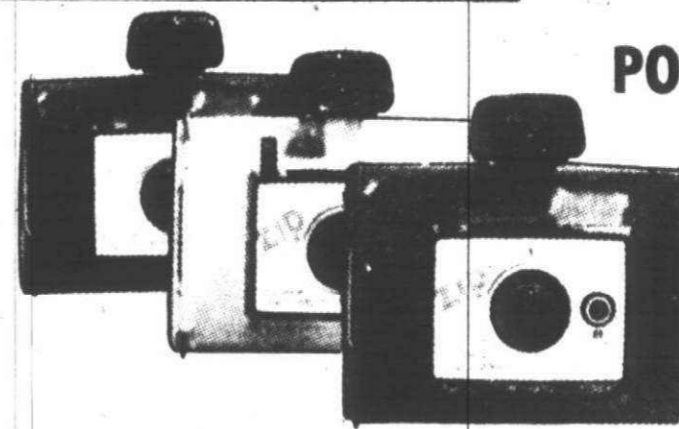

**POLAROID'S NEW ELECTRIC ZIP CAMERA**

Takes economical square, color or black and white pictures in seconds. Your choice of red, white or blue.

OUR REG. \$17.88

**\$16<sup>88</sup>**



**KODAK TELE-INSTAMATIC 608 CAMERA OUTFIT**

Normal and telephoto lens. Complete with film and fliptash.

**\$26<sup>67</sup>**

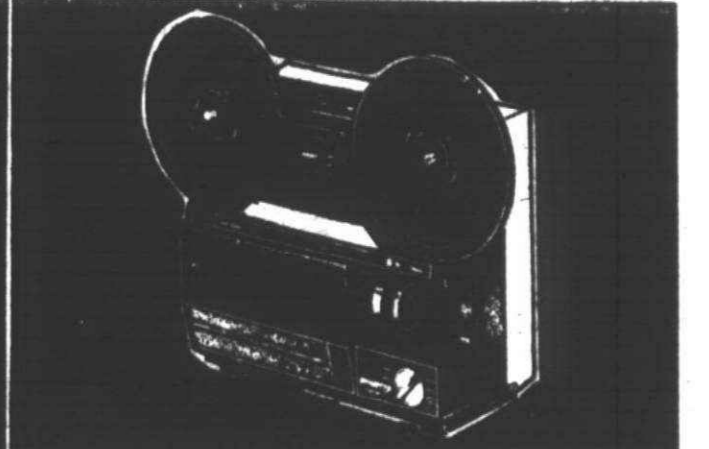

**BELL AND HOWELL MOVIE PROJECTOR**

• Model 1634CZ

OUR REG. \$139.97

**\$119<sup>97</sup>**

**SYLVANIA MAGICUBES**

Don't forget to buy film and flashcubes for Easter.

**\$1.34** sleeve  
LIMIT 4 PLEASE!

Why Pay More!



**SYLVANIA FLASHCUBES**

• Sleeve of 3 cubes  
• LIMIT 4 PLEASE!

**89¢** sleeve



Page 4 PRICES GOOD MONDAY APRIL 5 THRU SATURDAY APRIL 10, 1976.

MEIJER RESERVES THE RIGHT TO LIMIT SALES ACCORDING TO SPECIFIED LIMITS.

NO SALES TO DEALERS, INSTITUTIONS OR DISTRIBUTORS.

**MEIJER THRIFTY ACRES — 45001 FORD RD. AT CANTON CENTER RD.**

SHOP MONDAY THRU SATURDAY 8 A.M. TO 10:30 P.M. — SUNDAY 9 A.M. TO 7 P.M.

Why Pay More! Why Pay More! Why Pay More! Why Pay More! Why Pay More! Why Pay More!

**m** in the school supplies department



**MAVERICK PLAYING CARDS**  
Poker, Pinochle or Giant Face.

**2 \$1**  
DECKS FOR



**"HARD HEAD" FLAIR PENS**  
• Assorted colors

**Why Pay More!**  
**2 FOR \$1**

**m** in the record department



thrifty acres



**BOOK AND 45 rpm RECORD**

**76¢**



**ASSORTED L.P. RECORDS**

**\$1.54**  
ea.

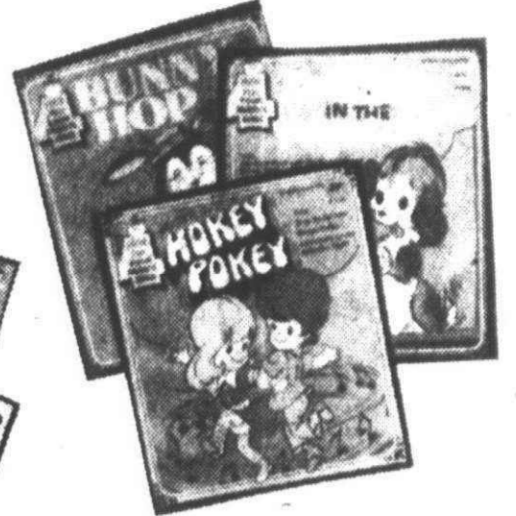

**ASSORTED 45 RECORDS**

**29¢**  
ea.

**LEGAL PAD**  
• 50 sheet count  
• 8 1/2" x 14"

**38¢**

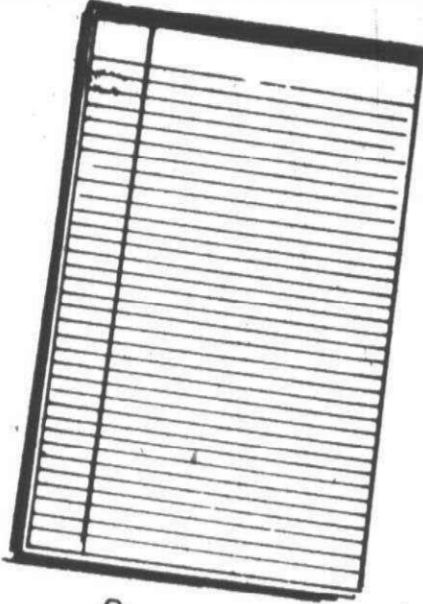

**FLORAL FANTASY TABLET & ENVELOPE**

• 44 ct. envelopes 3 1/4" x 6 1/2"  
• 80 sheet tablet 6 1/4" x 8 3/4"

YOUR CHOICE!

**2/\$1**

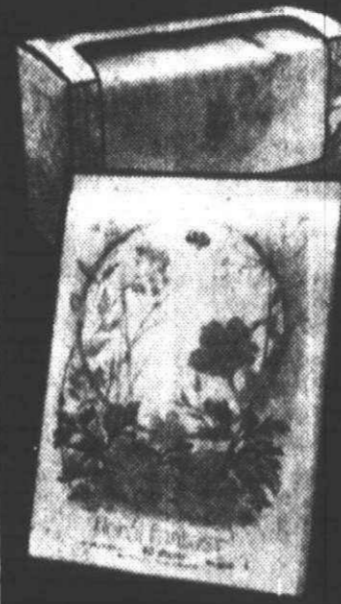

**ELMER'S GLUE-ALL**  
America's favorite glue. 1 1/4 fl. oz. bottle.

**4 FOR 88¢**

**CRAYOLA 24'S IN PLASTIC BOX**

• Non-toxic  
• Safe



**57¢**  
box

**FUNK & WAGNALLS Family Library of Great Music**

• Album #1 only 69¢  
• Album #2 with free binder only \$2.49  
• Albums #3-7 only \$2.49 ea.



**Why Pay More!**

**\$2.49**  
ea.

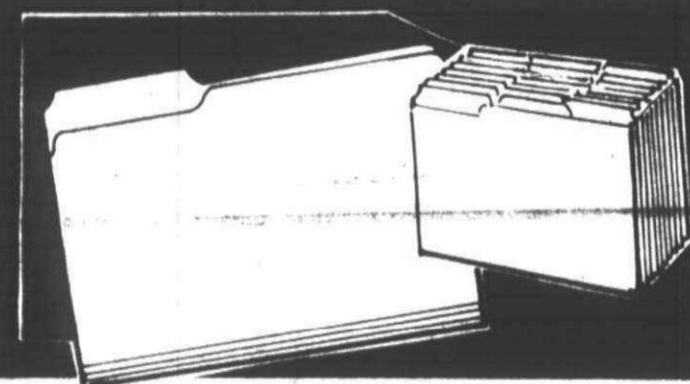

**IMPERIAL FILE FOLDERS**

• With reinforced tabs  
• 100 count box  
• 9 x 12 size

**\$3.99**



**WATERCOLORS**

• 8 count  
• Non-toxic, safe

**37¢**

**THIS WEEK'S STEREO ALBUM #8**

**Schubert**

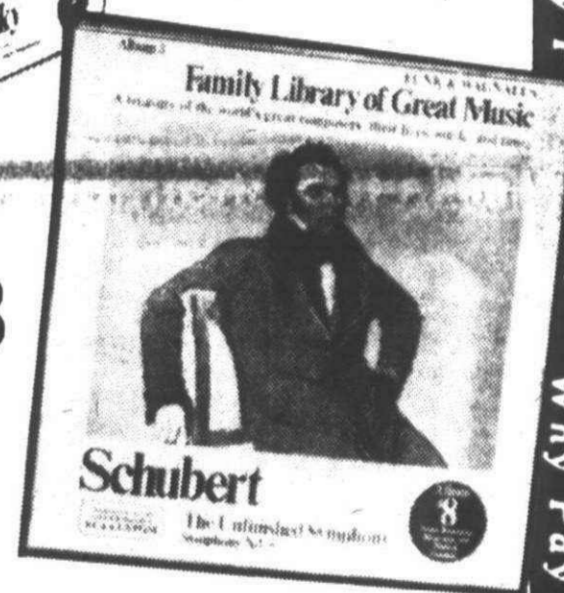

**m** in the jewelry/small appliance department

**NORELCO QUICK-DRY 1000 WATT HAIR DRYER**  
Nozzle attachment for spot drying. Four heat settings, thermostatically controlled. #HB1700.

OUR REG. \$23.88  
**\$16.97**



**SUNBEAM DIAL-A-STYLE MIST STICK WITH EXPANDABLE CURLER STYLER**

**\$18.88**

Gentle mist plus thermostatically controlled heat. Swivel cord, keep-cool tip. Twist "dial-tip" for desired curl size. #54-74.



**G.E. PORTABLE STEREO PHONOGRAPH**  
Automatic, drop-down 3-speed changer plays all sizes, 6" oval speakers. #V-935-6E.

OUR REG. \$44.88  
**\$39.97**

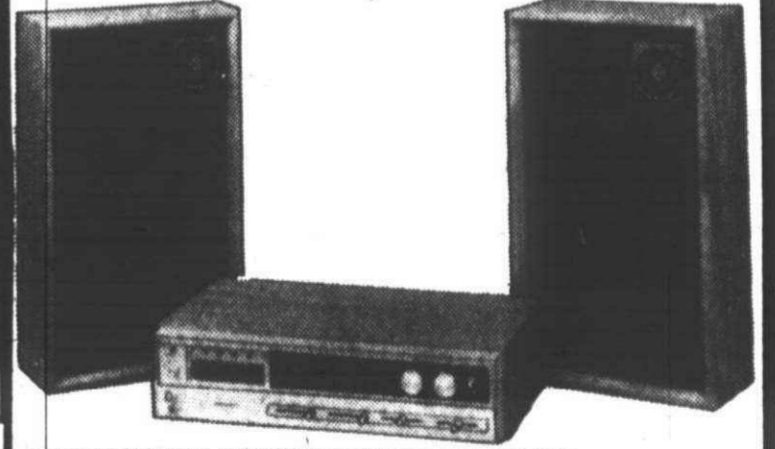

**SOUNDESIGN AM/FM STEREO RECEIVER WITH 8 TRACK TAPE PLAYER & CASSETTE PLAYER**

Slide controls. AFC for better FM reception, rotary function switch, Cassette features fast forward button, tape ejector, indicator light. #4645-633.

Save \$30.00  
OUR REG. \$149.88  
**\$119.88**

**WARING ELECTRIC CAN OPENER**  
Built-in magnetic lid lifter, bottle opener. Blade assembly pops out at push of button. #CO-11.

OUR REG. \$8.47  
**\$6.97**

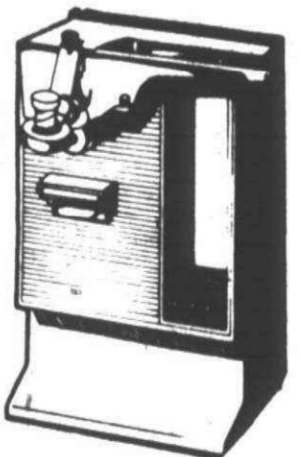

**CROCKERY COOK POT**

By Grandinette. 3 1/2 qt. size, white exterior. Has lo-hi heat control. #532W.

**\$12.97**



**SPRAY/STEAM DRY IRON**

25 steam vents, water window, fabric temperature dial. #F-92.

**\$13.88**

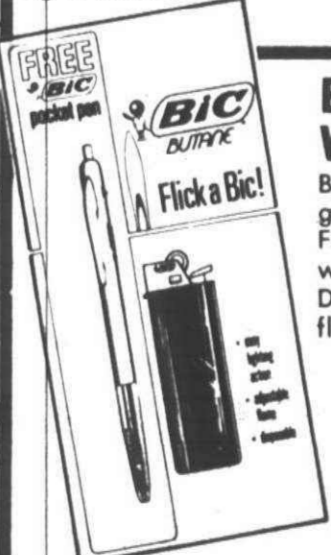

**BIC LIGHT & WRITE SPECIAL!**

Buy a Bic that lights and get a Bic that writes FREE! Bic Butane lighter with free Bic pen. Disposable. Adjustable flame.

OUR REG. \$1.19  
**88¢**

**MIRRO ELECTRIC 10-CUP PERK**

Flavor selector, coffee stays serving hot. Colormode-on-aluminum finish. (Poppy Red). #M-0184-39. OUR REG. \$12.97

**\$9.97**

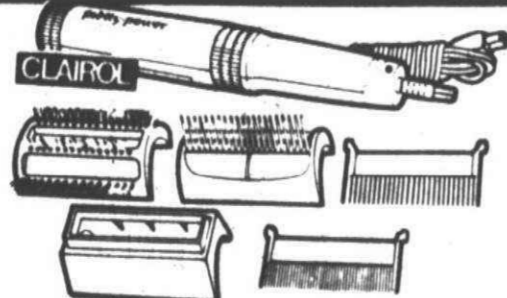

**PRETTY POWER HAIR DRYER**

Handles like a hairbrush. 750 watts, 2 speeds, 2 heat settings, 5 attachments. Per-simmon and white, 8 foot cord. #AFD-1.

**\$16.97**

**WESTCLOX ELECTRIC ALARM CLOCK WITH LIGHTED DIAL**

Drowse alarm. Softly lighted dial assures full night view. #20318.

OUR REG. \$5.97  
**\$3.97**



**SPIRIT OF '76 PIPE SET**

Bicentennial pipe smoking kit by Venturi with package of mild smoking tobacco.

OUR REG. \$3.97  
**\$2.97**

Tobacco Shop

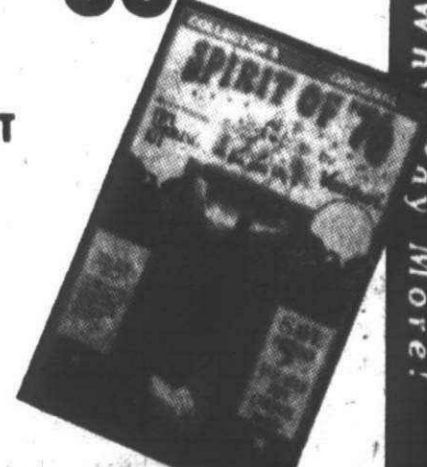

PRICES GOOD MONDAY APRIL 5 THRU SATURDAY APRIL 10, 1976.

MEIJER RESERVES THE RIGHT TO LIMIT SALES ACCORDING TO SPECIFIED LIMITS. NO SALES TO DEALERS, INSTITUTIONS OR DISTRIBUTORS. CHARGE ANYTHING IN THE STORE EXCEPT FOOD, LIQUOR AND SUPERMARKET ITEMS

Page 3



**YOU DON'T NEED CASH! USE EITHER OF THESE CONVENIENT CREDIT CARDS!**



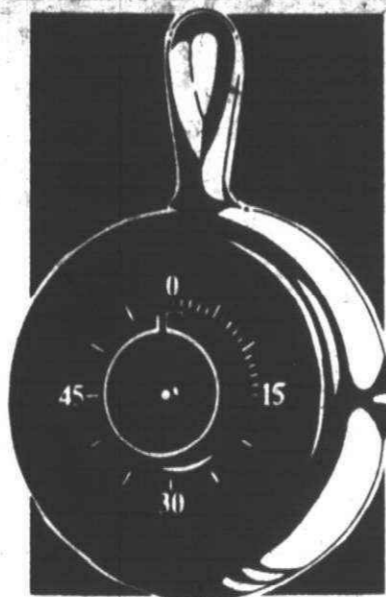

**SKILLET BELL TIMER**  
Measures to 60 minutes. Easy to set and read. Loud bell signal. Durable black plastic case. Hangs on your wall.  
AFTER AD \$5.27  
**\$3.77** EA.



**RUST STAIN REMOVER**  
• 6 fl. oz. can  
OUR REG. 97¢  
**67¢** EA.

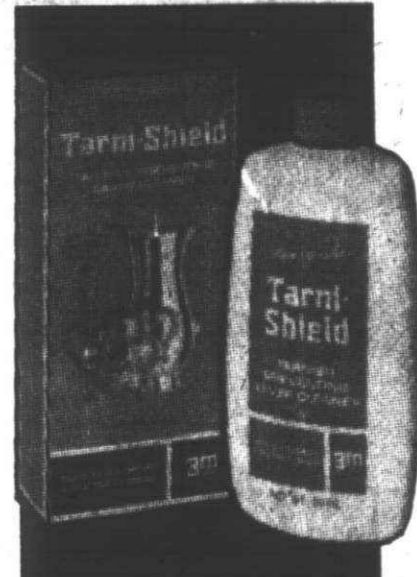

**3-M TARNI-SHIELD**  
Tarnish preventing silver cleaner. Keeps silver shining 5 to 6 times longer. 10 fl. oz. btl.  
OUR REG. \$2.17  
**\$1.77**



**BALL BICENTENNIAL IDEAL PINT JARS**  
Perfect for use as gift containers for candy, cookies, etc. Also may be used for storage containers and terrariums.  
**\$1.57** EA.



**9 OZ. PYREX® WARE MUGS**  
Matching Corolle designs - Old Town Blue, Butterfly Gold, Spring Blossom Green. Pkg. of 4.  
**\$3.27** PER PKG.

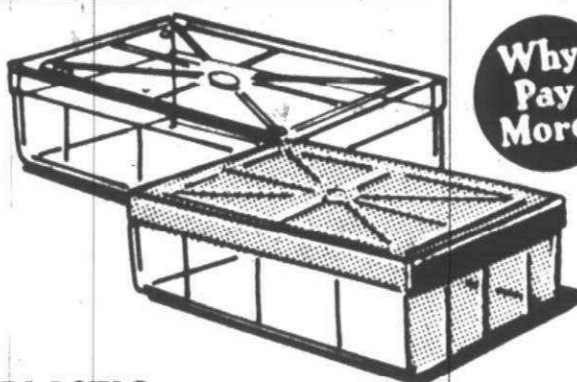

**PLASTIC SHOE BOXES**  
Self-stacking. Lids in clear and fashion colors. See-thru crystal clear bases.  
**2 FOR \$1**



**50 COUNT TRASH CAN LINER ROLL**  
Fits up to 26 gallon size trash can.  
(4' PER BAG)  
**\$2.00**



**CHILDREN'S DESIGN COOKIE TINS**  
• Three designs including Mickey Mouse, Holly Hobbie, and Urchins.  
• All metal with plastic lids.  
**\$1.47**

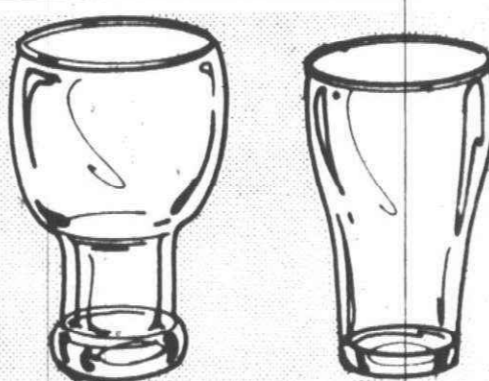

**GLASSWARE CASE SALE**  
By Federal Glass  
• Buy them by the case and save!  
• 12 oz. Cola Glasses  
• 16 oz. Beer Glasses  
**\$2.37** CASE OF 12  
(LESS THAN 20¢ PER GLASS)

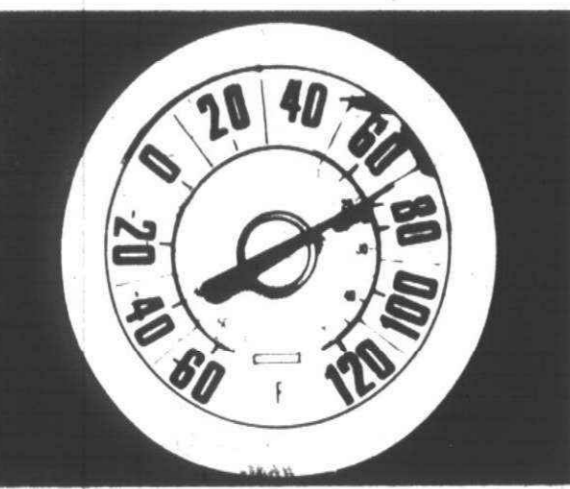

**SPRINGFIELD LARGE OUTDOOR THERMOMETER**  
12" size with bold numbers and huge brilliant pointer for easy reading from anywhere. Suitable for tree or fence mounting - 60° F to 120° F temperature range.  
AFTER AD \$7.47  
**\$5.97** EA.

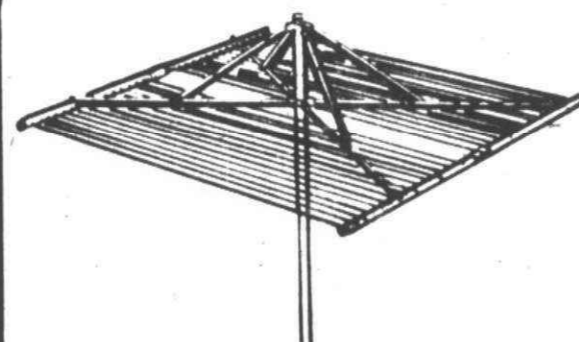

**BREEZAIRE OUTDOOR CLOTHES DRYER**  
• 73" high - 182" of drying space.  
• 1 1/2" galvanized center post.  
OUR REG. \$14.97  
SAVE \$4.00  
**\$10.97** EA.



**F POSTS**  
• Green painted 2" posts  
• 84" high with ground socket  
• 5 hooks  
OUR REG. \$5.97  
Save \$1.50  
**\$4.47** EA.

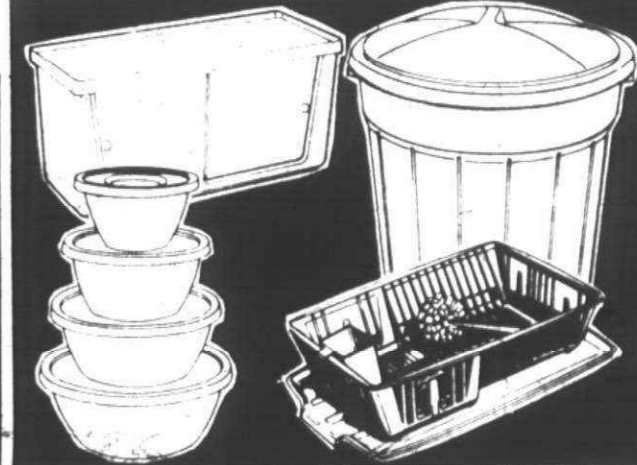

**HOUSEWARES PLASTIC SALE!**  
• 18 GALLON TRASH CAN WITH COVER  
• 5 PC. SINK SET  
• 8 PC. COVERED BOWL SET  
• STORAGE CABINET  
**YOUR CHOICE! \$1.97** ea.

**40 PIECE BLUE ONION DINNERWARE SET**  
Service for 8. Popular Blue Onion design on white earthenware. Set includes 8 each of - Dinner Plates, Cups, Saucers, Bread & Butter Plates, Soup/Cereal Bowls.  
**\$19.47** SET



**CENTENNIAL 7 PC. COOKWARE SET**  
Porcelain pan exteriors in attractive golden harvest color. Set includes 1 qt. & 2 qt. Covered Sauce Pans, 5 qt. Covered Dutch Oven, 10" Skillet (shares Dutch Oven Cover).  
OUR REG. \$19.87  
SAVE \$5.00  
**\$14.87** SET

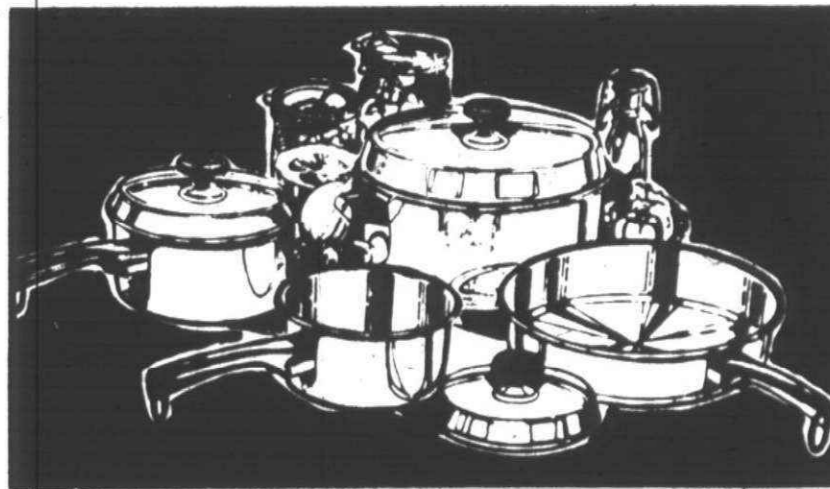

**10" COVERED PORCELAIN SKILLET**  
Heavy weight porcelain in beige color. Ovenproof knob and handle. Smooth-as-glass ceramic finish is non-porous and cleans easily.  
OUR REG. \$6.97  
SAVE \$2.00  
**\$4.97** EA.

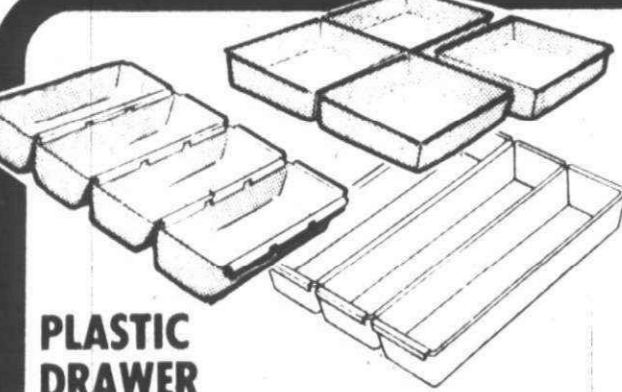

**PLASTIC DRAWER ORGANIZERS**  
3 distinct sizes can be hooked together to make combinations. Helps keep things organized.  
**3 FOR \$1**

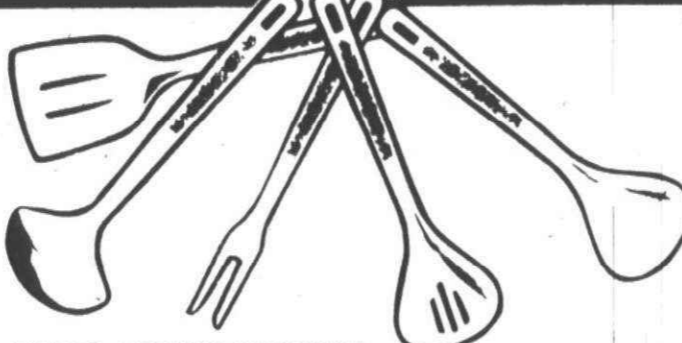

**EKCO SPICE DESIGN NYLON TOOLS**  
All white with the popular spice decoration on the handles. Dishwasher safe. Ladle, Fork, Turner, Slotted Spoon or Basting Spoon.  
YOUR CHOICE!  
**3 FOR \$1**

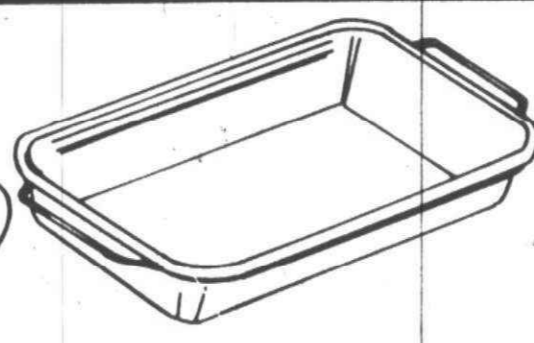

**LASAGNA PAN**  
16" size in lemon yellow porcelain color. A glass-smooth surface that is easy to clean. Individually boxed.  
OUR REG. \$4.97  
**\$3.97** EA.



**CORRUGATED TABLE**  
Wood-fiberboard top resists stain and moisture. Base can support up to 100 lbs. 27" high by 19" round. Add a decorator touch by covering with a 70" or 72" round cloth.  
OUR REG. \$3.47  
**\$2.47** EA.

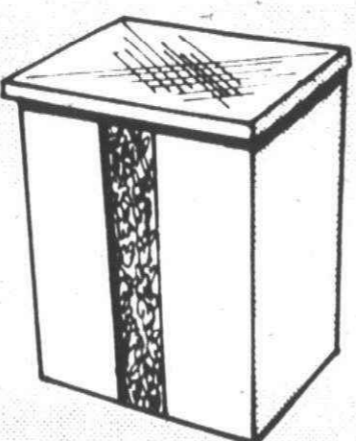

**FESTIVAL FLORAL SIT-ON HAMPER**  
Sturdy hinged cover makes comfortable vanity seat. In white, avocado, gold and blue.  
OUR REG. \$4.47  
**\$2.77** EA.

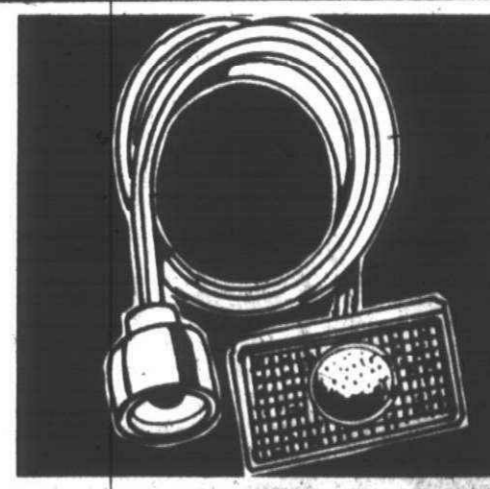

**SHAMPOO AND BATH SPRAY**  
Fits most faucets. contoured massage brush. In avocado, gold and white.  
**77¢** EA.

Why Pay More! Why Pay More! Why Pay More! Why Pay More! Why Pay More! Why Pay More! Why Pay More! Why Pay More! Why Pay More! Why Pay More!

**CHAIN LINK FENCE FABRIC**

- 50 foot roll
- 1 1/2 gauge

**\$29<sup>88</sup>**



**GALVANIZED EAVESTROUGH**

- Available in 10 ft. lengths

ALSO AVAILABLE GALVANIZED  
DOWNSPOUTS AND ACCESSORIES

**\$1<sup>98</sup>**

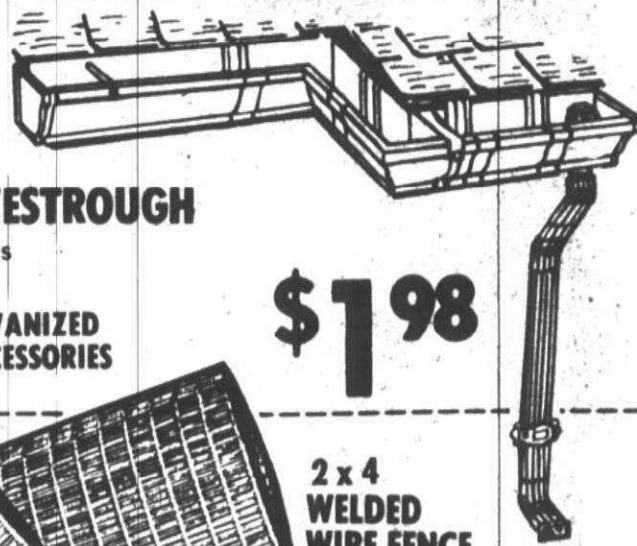

**thrifty acres**

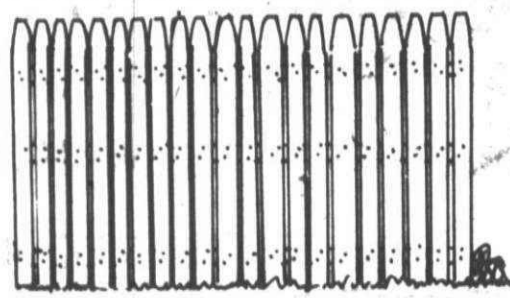

**STOCKAGE FENCE**

- 6' x 8' cedar assembled

OUR REG. \$29.88  
**\$26<sup>88</sup>**

POSTS.....\$3.99 ea.

Why Pay More!

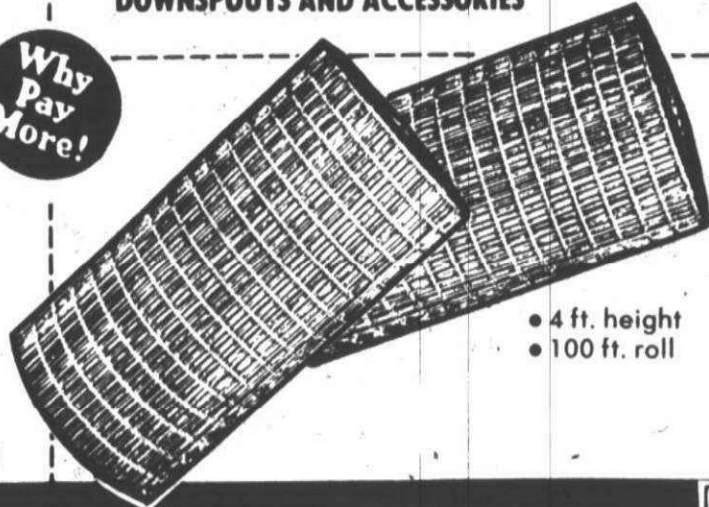

2 x 4  
WELDED  
WIRE FENCE

**\$31<sup>88</sup>**

- 4 ft. height
- 100 ft. roll

m in the electrical department

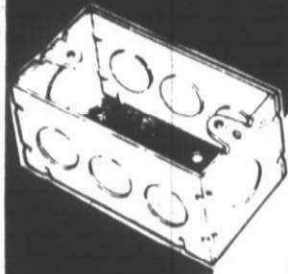

**HANDY BOX**

- 4 inches long
- 2 1/2" wide
- 3 1/2" knockouts
- Model 103W

**33<sup>c</sup>**

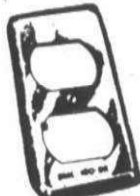

**HANDY BOX RECEPTACLE COVER**

- 1/2" raised, 4 1/4" long. For duplex flush receptacles. #BMC-100DR.

OUR REG. 18<sup>c</sup>

**12<sup>c</sup>**

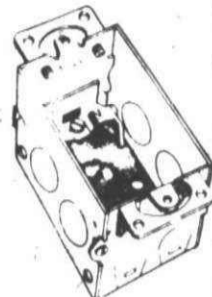

**SWITCH BOX WITH ROMEX CLAMPS**

- 2" deep, 3" long
- 2" wide
- Model 51-LC

**51<sup>c</sup>**

m in the plumbing department

**PORTA PUMP**

Portable utility pump. Powerful 1/2 h.p. motor. Self priming. High capacity pump designed to boost line pressure. #PC-4. OUR REG. \$65.92

**\$57<sup>77</sup>**



**SHALLOW WELL PUMP SYSTEM**

With 12 gallon tank. Heavy duty motor. Overload protection switch. Automatic pressure switch. #SJD-3-12P.

SIMILAR TO ILLUSTRATION

OUR REG. \$146.41

**\$111<sup>11</sup>**

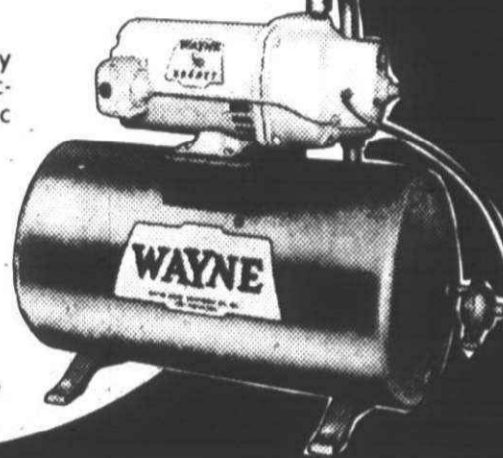

m in the hardware department

Why Pay More!

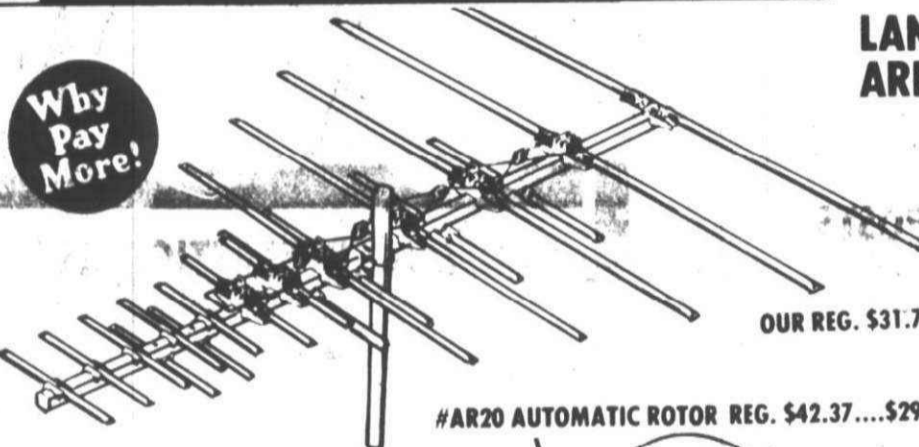

**LANCE FAR FRINGE AREA ANTENNA KIT**

18 element. UHF/VHF. For color or black and white. Complete kit. #LC38.

OUR REG. \$31.77

**\$24<sup>88</sup>**

#AR20 AUTOMATIC ROTOR REG. \$42.37.....\$29.95

Why Pay More!

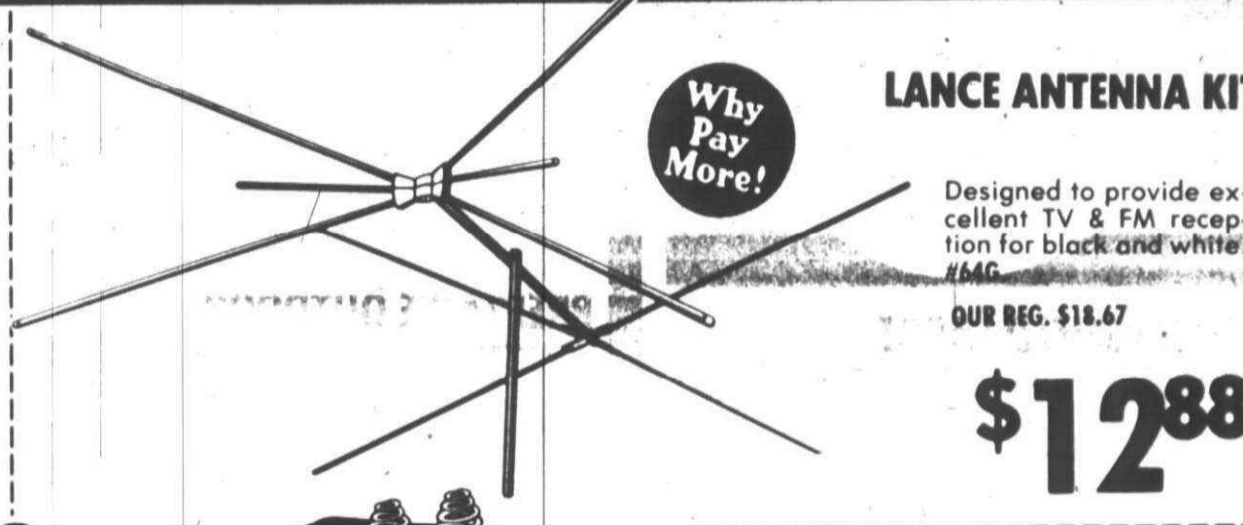

**LANCE ANTENNA KIT**

Designed to provide excellent TV & FM reception for black and white. #AAC.

OUR REG. \$18.67

**\$12<sup>88</sup>**

**LANCE INDOOR ANTENNA**

- UHF/VHF
- Model LCS

OUR REG. \$9.97

**\$6<sup>97</sup>**

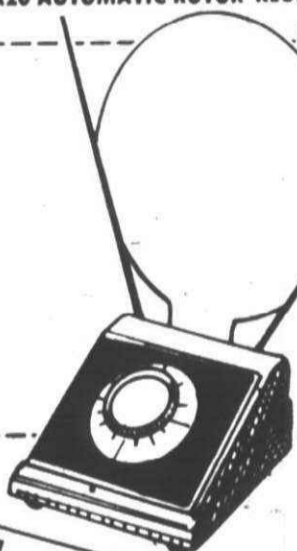

**6 VOLT HEAVY DUTY BATTERY #944**

**\$1<sup>37</sup>**

"C" OR "D" SIZE HEAVY DUTY BATTERIES

**49<sup>c</sup>** pkg. of 2



**POULAN 10 INCH CHAIN SAW**

- Model 20-10

OUR REG. \$114.95

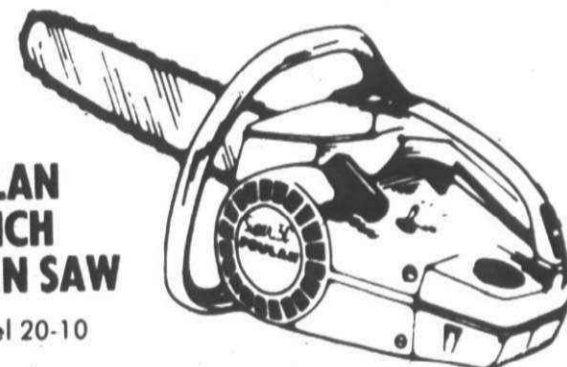

**\$99<sup>95</sup>**

#25DA POULAN GAS CHAIN SAW WITH FREE CARRYING CASE & CHAIN..... \$169.95  
#1000 POULAN ELECTRIC 10" CHAIN SAW REG. \$59.95. \$49.95  
BAR AND CHAIN OIL GALLON \$2.99.. QUART .99<sup>c</sup>

**DOW URETHANE BOND**

Exceptional bonding on wood, metal, glass, ceramics, fiberglass, leather, vinyl and much more. #8662.

OUR REG. \$1.37

**88<sup>c</sup>**



Why Pay More!



**EAGLE PUMP OILER**

- Model 33

OUR REG. \$2.99

**\$1<sup>99</sup>**

m in the auto supply department

**SAFETY HELMETS**  
POLYCARBONATE OR FIBERGLASS SOLID COLORS METALFLAKES OR FANCY STYLES MOTORCYCLE  
**\$500 OFF WITH COUPON**  
GOOD 4/5 THRU 4/10/76  
COUPON LIMITED TO ONE PER FAMILY. DEPT. 860



**MOTORCRAFT OIL FILTER**

The "Long Life" oil filter. #FL-1.

OUR REG. \$3.19

**\$1<sup>87</sup>**

Why Pay More!



**LEE MUFFLERS**

- O.E.M. replacement

OUR REG. \$13.47

**\$10<sup>97</sup>**

**SPARK PLUGS**  
ANY IN STOCK SET OF 6  
**\$100 OFF WITH COUPON**  
GOOD 4/5 THRU 4/10/76  
COUPON LIMITED TO ONE PER FAMILY. DEPT. 860

LIKE IT? BUY IT WITH—



Anything in the store except food and Super Market Items!

**WIRE SETS**  
O.E.M. IGNITION  
DELCO, MOTORCRAFT & MOPAR  
From \$4.87  
**\$100 OFF WITH COUPON**  
GOOD 4/5 THRU 4/10/76  
COUPON LIMITED TO ONE PER FAMILY. DEPT. 861

**TUNE UP KITS**  
ANY IN STOCK  
**50c OFF WITH COUPON**  
GOOD 4/5 THRU 4/10/76  
COUPON LIMITED TO ONE PER FAMILY. DEPT. 860

**SPARK PLUGS**  
ANY IN STOCK SET OF 8  
**\$150 OFF WITH COUPON**  
GOOD 4/5 THRU 4/10/76  
COUPON LIMITED TO ONE PER FAMILY. DEPT. 860

PRICES GOOD MONDAY APRIL 5 THRU SATURDAY APRIL 10, 1976.

MEIJER RESERVES THE RIGHT TO LIMIT SALES ACCORDING TO SPECIFIED LIMITS.

NO SALES TO DEALERS, INSTITUTIONS OR DISTRIBUTORS.

Page 7

CHARGE ANYTHING IN THE STORE EXCEPT FOOD, LIQUOR AND SUPERMARKET ITEMS

**YOU DON'T NEED CASH! USE EITHER OF THESE CONVENIENT CREDIT CARDS!**



Pay More! Why Pay More! Why Pay More! Why Pay More! Why Pay More! Why Pay More!

**m** in the paint department

# NOW AT MEIJER

## A FULL LINE OF....

# Glidden Paint

Why Pay More!

### SPECIAL GLIDDEN INTRODUCTORY SALE...

We've added that nationally famous Glidden SPRED line of quality paint to our shelves! That means there's more color, more quality and more variety than ever before in store for the do-it-yourselfer at Meijer! Shop for these top performing paints and you'll enjoy everyday low prices...but if you decide to stock up now, during our Special Introductory Sale, you can save. What a great way to get acquainted with our great new paint line!



### GLIDDEN SPRED SATIN WALL PAINT

Several colors to choose from. Smooth, rich latex for top coverage and superior hiding. Durable finish scrubs clean. Goes on easily with brush or roller; dries in 30 minutes.

**\$6.97** OUR REG. \$9.77  
GALLON

Why Pay More! **TINTS \$7.47** GALLON

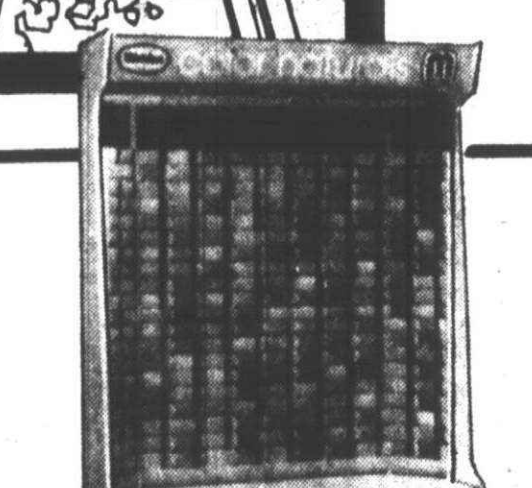

#### GLIDDEN'S COLOR NATURAL

When it comes to decorating, color is what counts -- and Glidden's COLOR NATURALS puts 900 of today's most popular shades at your fingertips. Each of these colors has been carefully chosen by professional decorators, so you know choice is in touch with today's trends. The displays are dynamic -- using scenes from nature to identify color groupings -- making color selection easier and more fun. Even the color chips are unique -- each huge 4" chip is striped to include accent shades to help you choose co-ordinating carpeting, upholstery, draperies and wall covering. Work with COLOR NATURALS is like getting professional decorating assistance -- FREE!



<b>GLIDDEN SPRED LATEX ENAMEL</b> TINTS...\$9.47 GAL. OUR REG. \$11.38	<b>\$8.97</b> GAL.	<b>GLIDDEN SPRED LATEX GLOSS</b> HOUSE & TRIM PAINT TINTS...\$9.47 GAL. OUR REG. \$11.38	<b>\$8.97</b> GAL.
<b>GLIDDEN SPRED HOUSE PAINT</b> TINTS...\$8.47 GAL. OUR REG. \$9.88	<b>\$7.97</b> GAL.	<b>SPRED LATEX FLAT WALL PAINT</b> TINTS...\$5.99 GAL. OUR REG. \$6.99	<b>\$5.49</b> GAL.
<b>GLIDDEN SPRED GEL-FLO</b> HOUSE & TRIM PAINT OUR REG. \$12.99	<b>\$10.97</b> GAL.	<b>GLIDDEN SPRED URETHANE FLORENAMEL</b> OUR REG. \$12.99	<b>\$10.97</b> GAL.
<b>SPRED LATEX WALL AND TRIM LOW LUSTRE</b> TINTS...\$7.99 GAL. OUR REG. \$9.49	<b>\$7.49</b> GAL.	<b>GLIDDEN LATEX REDWOOD STAIN</b> OUR REG. \$4.16	<b>\$2.99</b> GAL.



**4" NYLON TEXTURE BRUSH**  
The Texturizer. Specially designed for texture, stipple and sand paints. Create your own designs.  
OUR REG. \$3.99  
**\$2.99** EA.

LIKE IT? BUY IT WITH...  
BANKAMERICA®  
Master Charge  
Anything in the store except food and beer. (Market hours)

**1-1/2" MEIJER GOOD NYLON BRUSH**  
100% nylon. For latex and water base paints, rubber, acrylic, vinyl, varnish and enamel.  
OUR REG. 79¢  
**64¢** EA.



**BONDEX CEILING - WALL PATCH 'N' REPAIR KIT**  
Kit contains: 2 lbs. patching powder compound, 20 ft. rubberized patching tape, sandpaper, and plastic patching tool.  
OUR REG. \$2.99  
**\$2.19** KIT

Why Pay More! Why Pay More! Why Pay More! Why Pay More! Why Pay More! Why Pay More! Why Pay More! Why Pay More! Why Pay More! Why Pay More!

Page 8 PRICES GOOD MONDAY APRIL 5 THRU SATURDAY APRIL 10, 1976. MEIJER RESERVES THE RIGHT TO LIMIT SALES ACCORDING TO SPECIFIED LIMITS. NO SALES TO DEALERS, INSTITUTIONS OR DISTRIBUTORS.

**MEIJER THRIFTY ACRES — 45001 FORD RD. AT CANTON CENTER RD.**  
SHOP MONDAY THRU SATURDAY 8 A.M. TO 10:30 P.M. — SUNDAY 9 A.M. TO 7 P.M.



Your



# Trout Fishing Headquarters

1976 FISHING LICENSES AVAILABLE IN THE SPORTING GOODS DEPT.

**TRUE TEMPER.**

UNI-SPIN COMBINATIONS

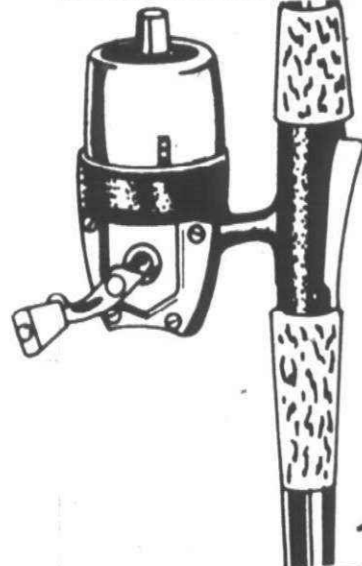

## TRUE TEMPER UNI SPIN COMBO

Rod 5 1/2' 2-piece solid glass. Fast action. Magnum butt for distance and strength. Reel basic 63 Uni-Spin (right at left handed). Prespooled; 100 yards of 10 lb. test monofilament. #633RBP & #633LBP.

OUR REG. \$27.97

SAVE \$5 **\$22.97**

**JOHNSON CENTURY SPINCAST REEL & 6' 2-PC. HOLLOW GLASS ROD COMBINATION**

**\$15.94**

COMBINATION

Johnson Spincast reel features "selecto-dial" multi-shoe drag, dual anti-reverse, tungsten carbide pickup pin. With 200 yards of 10 lb. test mono. Rod is a 6' 2-piece hollow glass rod by Gladding-South Bend (U.S. Fiberglass).

**DAIWA** in the sporting goods department

**DAIWA 7450HRL SPINNING COMBINATION**

SAVE \$5

OUR REG. \$27.85 **\$22.85**

COMBINATION

A 7' 2-pc. brown fast-taper tubular fiberglass spinning rod by Master. Light-action with stainless steel chrome-plated guides and tip top and glass ferrule. Ball-bearing Daiwa Spinning Reel with a line capacity of 255 yards of 10 lb. mono. Gear Ratio of 4.1 to 1. Weighs 13 oz. Reel is convertible from left to right hand.

**H.I. SINGLE ACTION FLY REEL AND H.I. 8' HOLLOW GLASS FLY ROD COMBINATION**

Offers excellent performance at an economical price. Reel is rugged aluminum construction and holds 30 yards of fly line. Medium weight, hollow glass fly rod is perfect for trout and panfish. #1856 REEL.

SAVE \$4

OUR REG. \$14.94 **\$10.94**

COMBINATION



SAVE 50% STOCK UP NOW ON PREMIUM GERMAN MONOFILAMENT

DAIWA "MONO DEX" LINE 4 LB. TEST MONO - 280 YDS. REG. \$2.49	\$1.24
6 LB. TEST MONO - 270 YDS. REG. \$2.69	\$1.34
8 LB. TEST MONO - 240 YDS. REG. \$2.89	\$1.44
10 LB. TEST MONO - 240 YDS. REG. \$3.09	\$1.54
12 LB. TEST MONO - 240 YDS. REG. \$3.39	\$1.68
15 LB. TEST MONO - 240 YDS. REG. \$3.69	\$1.84

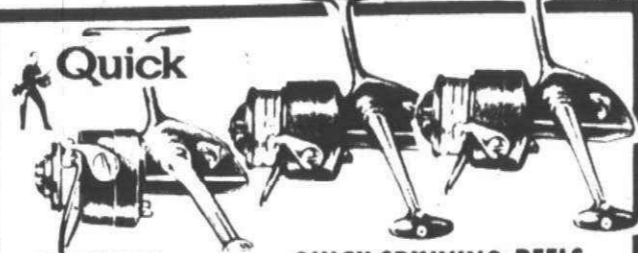

- QUICK 110** QUICK SPINNING REELS (LINE NOT INCLUDED)  
CAP. 200 YDS. OF 6 LB. MONO GEAR RATIO 4.75 TO 1
- QUICK 220**  
CAP. 250 YDS. OF 8 LB. MONO GEAR RATIO 3.55 TO 1
- QUICK 330**  
CAP. 265 YDS. OF 10 LB. MONO GEAR RATIO 3.5 TO 1

OUR REG. \$26.97 **YOUR CHOICE! \$21.97** EA. SAVE \$5.00



**#935 CLASSIC FRESHWATER SALTWATER SPINNING REEL** By South Bend  
OUR REG. \$14.97 **\$10.97**

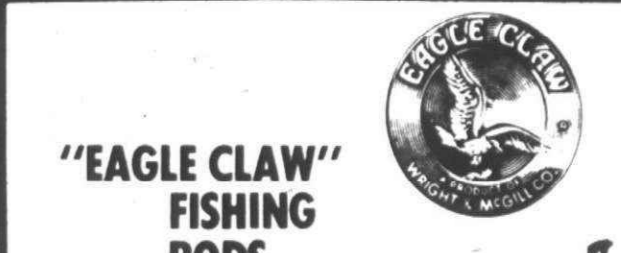

**"EAGLE CLAW" FISHING RODS** By Wright & McGill  
Michigan series fishing rods. Ultra-light:  
• 5-1/2' Choose from:  
• 6-1/2' Spin  
• 7' Spinning  
• 6-1/2' Spincast  
• 8' Fly Rod

OUR REG. \$13.77



**DELUXE RUBBER & NYLON CHEST-HIGH WADERS**  
ANY IN STOCK **\$3.00 OFF** WITH COUPON  
Sporting Goods Dept.  
GOOD 4/5 THRU 4/10/76  
Coupon limited to one per family. DEPT 490

**SMELT NET**  
ANY IN STOCK **\$1.00 OFF** WITH COUPON  
GOOD 4/5 THRU 4/10/76  
Coupon limited to one per family. DEPT 490

**COLORADO SPINNERS**  
Assorted sizes. OUR REG. 53¢ **44¢**

**B-2 OR B-3 MEPPS**  
FRENCH SPINNER LURES OUR REG. 99¢ **83¢** EA.

**BO - B1 FRENCH SPINNERS** By Mepps  
OUR REG. 89¢ **73¢**

**BULK SPLIT SHOT** **\$1.29** EA.

**PANTHER MARTIN SPINNER LURE** By Harrison  
#04218 - 2PMF 1/16 OZ. - REG. \$1.19  
#04219 - 40MF 1/8 OZ. - REG. \$1.27  
YOUR CHOICE! **99¢** EA.

**FISHERMAN'S SHOT PLIERS**  
Fold-out hook disgorger.  
OUR REG. \$1.49 **\$1.19** PR.

**PLANO TACKLE BOX**  
2 trays with 14 big compartments. Size 14 1/2" x 7 3/4" x 7 1/2". #4420.  
OUR REG. \$7.97 **\$6.77**

**#MT-8 TROUT NET** By Cumings  
New scoop shape. 11 1/2" x 16 1/2". Net size 26".  
OUR REG. \$2.39 **\$1.89** EA.

**"LITTLE CHIEF" ELECTRIC SMOKER** By Lubr Jensen  
An aluminum smoker that smokes and cures up to 20 lbs. of meat in 10 to 12 hours. #20.  
**\$24.97**

**HICKORY CHIPS** By Lubr Jensen  
100% pure Ozark kiln-dried hickory. **\$1.17** EA.

**SPAWN SACKS**  
Hand tied. Pack of 12. **\$1.25**

**LUHR JENSEN "LITTLE JEWEL" SPOONS**  
1/4, 1/3, 2/5 OZ. YOUR CHOICE! **87¢**

in the domestics department

**BATH TOWEL ENSEMBLE**  
Conventional looped terry for greater absorbency. Assorted prints and coordinated solid colors

**BATH TOWEL** **\$1.49** EA.

**HAND TOWEL** **89¢** EA.

**WASH CLOTH** **69¢** EA.

**Special Purchase**

**BED PILLOWS**  
Foam filled. Assorted juvenile print tickings. Finish size of 16" x 23".  
AFTER AD **\$1.79**  
**2/\$3.00**

**POSTA RUG**  
Hang it! Walk on it! Wash it! It's a wall poster, it won't tear, it needs no frame. It's a rug. It's machine washable. 100% Dacron polyester pile. 17" x 23" size.  
**2/\$5.00**

**Special Purchase**

**PERMA PRESS TABLECLOTH**  
Assorted solid colors. Perma-press soil release. 52" x 70" or 60" x 84"  
YOUR CHOICE! **\$3.99** EA.

**Special Purchase**

**DRAPERY FABRIC**  
Assorted drapery fabric in many pattern designs and color combinations. 45" to 54" widths. 2 to 10 yard lengths.  
**\$1.19** YARD



MEIJER SNACK BAR SPECIAL MEIJER SNACK BAR MEIJER FLAVOR OF THE WEEK MEIJER FLAVOR OF THE WEEK

# GLAZED DONUTS WEEKLY SPECIAL!

MEIJER DONUT SHOP



## 6/79¢



# INDIAN BREAD

OUR REG. 55¢

## 49¢

LOAF

BAKERY AT THE FRONT OF THE STORE

MEIJER SNACK BAR SPECIAL MEIJER DONUT SHOP SPECIAL

### PURPLE COW AT THE FRONT OF THE STORE

FLAVOR OF THE WEEK!



## CHOCOLATE MARBEL ICE CREAM

SINGLE DIP CONE

### 15¢ EA.

DOUBLE DIP CONE

### 29¢ EA.

MEIJER DONUT SHOP SPECIAL MEIJER DONUT SHOP SPECIAL

### SNACK BAR SPECIAL OF THE WEEK!



## BBQ PLATE

• French fries & cole slaw.

### 89¢

PLATE

## CHOCOLATE SUNDAE

Two scoops vanilla ice cream, topped with chocolate sauce.

### 34¢ EA.

At the front of the store

Why Pay More! Why Pay More! Why Pay More!

# HISTORICAL FLAG COLLECTION

YOUR HERITAGE IS WORTH KNOWING ABOUT... AND TELLING YOUR CHILDREN ABOUT...

Get the Spirit... The Spirit of '76 comes alive at all Meijer stores. For the first time Meijer is presenting an original collection of miniature flags from our American Heritage. Flags with such great historical significance as the Green Mountain Boys; The Bucks of America; The Know Nothing Flag; The Flag of the Union; The Bennington Flag, and many more. Each has its own story of how it represents a part of our history. Buy your first two flags this week and you'll get a third, the Bennington Flag, free with coupon.

## 4" x 6" FABRIC MINIATURE FLAGS

3 FOR 99¢

PLASTIC CAROUSEL FLAG STAND

OUR REG. \$1.99

THIS WEEK 99¢ WITH COUPON





### GREAT MEDALLION FLAG

### FLAG OF THE BEDFORD MINUTEMEN

### THE BUNKER HILL FLAG

## THIS WEEK'S FEATURED FLAGS

MEIJER

# CAROUSEL FLAG STANDS

REG. \$1.99

## 99¢

WITH COUPON

GOOD 4/5 THRU 4/10/76

Coupon limited to one per family. DEPT. 980

### COLLECT ALL 48 FLAGS!

## 3 NEW FLAGS OFFERED EACH WEEK FOR 16 WEEKS!

APRIL 5	GREAT MEDALLION FLAG, FLAG OF THE BEDFORD MINUTEMEN, THE BUNKER HILL FLAG
APRIL 12	THE FORT INDEPENDENCE FLAG, FRENCH FLEUR DE LIS, PINE TREE FLAG
APRIL 19	DOUBLE WREATH FLAG, MOULTRIE FLAG, FLAG OF THE HANOVER ASSOCIATIONS
APRIL 26	SEA CAPTAIN'S FLAG, CONFEDERATE BATTLE ENSIGN, THE FLAG OF THE N. C. MILITIA
MAY 3	GUILFORD FLAG
MAY 10	FLAG OF UNION, KNOW-NOTHING FLAG, FLAG OF THE FIRST RHODE ISLAND REGIMENT
MAY 17	THE TEXEL FLAG, FLAG OF PROCTOR'S INDEPENDENT BATTALION, GREAT STAR FLAG OF 1836
MAY 24	THE 48-STAR FLAG, THE CONFEDERATE WHITE MAN'S FLAG, THE EASTON FLAG
MAY 31	FLAG OF THE HAYES ARCTIC EXPEDITION, CAMOUFLAGED GREAT STAR FLAG, RED ENSIGN OF ENGLAND - RED CROSS
JUNE 7	FLAG OF THE THIRD MARYLAND REGIMENT, THE CONFEDERATE STARS AND BARS, SOUTH CAROLINA MARY STANDARD
JUNE 14	CROSS OF ST. ANDREW FLAG, THE GRAND UNION FLAG, FLAG OF THE SECOND CONNECTICUT REGIMENT
JUNE 21	FORT McHENRY FLAG, GREAT FLOWER FLAG, BANNER OF THE SOCIETY OF THE CINCINNATI
	THE CENTENNIAL FLAG, HULBERT FLAG, THE REVENUE CUTTERS FLAG

ALSO AVAILABLE 16 PAGE BOOK OF THE HISTORICAL FLAG COLLECTION - 19¢

Why Pay More!



## JOHNSON'S ODOR-EATERS

Removes odor from feet, socks, shoes.

### 97¢

Health & Beauty Aids Dept.

MEIJER in the health and beauty aids department

# BAN ROLL-ON ANTI-PERSPIRANT

## 48¢

1 FL. OZ.

Health & Beauty Aids Dept.



## ROSE MILK SKIN CARE CREAM

8 FL. OZ.

### 88¢

Health & Beauty Aids Dept.

Why Pay More!



## Gillette Twinjector Blades

• 5 ct. pkg.

### 88¢

PKG.

Health & Beauty Aids Dept.

NEW!



## NESTLE SWEET NATURE SHAMPOO OR CONDITIONER

YOUR CHOICE!

16 FL. OZ.

OUR REG. 96¢

### 77¢

Health & Beauty Aids Dept.

NEW!



## BRECK CLEAN RINSE

16 FL. OZ.

• 3 fresh scents.

OUR REG. \$1.88

### \$1.37

Health & Beauty Aids Dept.



## DESITIN LOTION

• Medicated hand lotion.

10 OZ. NET WT.

### 88¢

Health & Beauty Aids Dept.

Why Pay More!



## DI-GEL® ANTACID TABLETS

Anti-Gas Antacid

100 COUNT

### \$1.09

Health & Beauty Dept.

NEW!



## WHITE RAIN NON AEROSOL HAIR SPRAY

• Extra Hold & Unscented

• 8 fl. oz.

### \$1.18

Health & Beauty Aids Dept.



## BRECK GOLD SHAMPOO

11 FL. OZ.

### 97¢

Health & Beauty Aids Dept.



## SCOPE MOUTHWASH

18 FL. OZ.

### 89¢

Health & Beauty Aids Dept.

MEIJER

REGULAR OR WITH IRON FORMULA

40¢ COUPON



## FLINTSTONE MULTIPLE VITAMINS

• 100 COUNT

### 40¢ OFF

WITH COUPON

GOOD 4/5 THRU 4/10/76

Coupon limited to one per family. DEPT. 989

HEAD & SHOULDERS SHAMPOO

7 FL. OZ. LOTION, 4 OZ. NET WT. TUBE, 4 OZ. NET WT. JAR

YOUR CHOICE!

### 84¢

Health & Beauty Aids Dept.

LOVING CARE COLOR FOAM HAIR COLORING

### \$1.77 EA.

Health & Beauty Aids Dept.



## VICKS SINEX NASAL SPRAY

.5 FL. OZ.

### 88¢

Health & Beauty Aids Dept.

SAVE UP TO 13%

**GAYLORD**

**SOLID PACK MARGARINE**

16 oz. wt. pkg.

**18¢**

**LIQUID DISH DETERGENT AJAX**

13 1/2 fl. oz. bottle

**59¢**

**GLASS PLUS WINDOW CLEANER**

22 fl. oz. bottle

**73¢**

**BORDEN'S CREMORA**

16 oz. jar

**79¢**

**FRENCH'S COUNTRY STYLE MASHED POTATOES**

28 oz. jar

**89¢**

SAVE UP TO 24%

**Food Club**

**SNACK CRACKERS**

11 oz. wt. box

**29¢**

**SUGAR FREE OR REGULAR SEVEN UP**

16 fl. oz. NR bottles (8 pack)

**\$1.19**

**MR. COFFEE COFFEE FILTERS**

50 count box

**3/\$1**

**ORTEGA TACO SEASONING**

1-1/4 oz. pkg.

**5/\$1**

SAVE UP TO 41% ON 3 PKGS.

**ORTEGA**

**TOSTADO & TACO SHELLS**

10 count 4 oz. wt. box

**3/\$1**

SAVE 10%

**WHITE OR ASSORTED**

**WHITE CLOUD TOILET TISSUE**

4 roll pkg.

**59¢**

SAVE UP TO 20%

**Food Club**

**RAISIN BRAN**

20 oz. wt. box

**69¢**

SAVE 10% ON 3 CANS

**Food Club**

**MUSHROOMS STEMS & PIECES**

4 oz. wt. can

**3/95¢**

**Passover 1976 פסח לפסח**

**MAVIN MATZO BALL SOUP**

32 oz. can

**59¢**

**GOODMAN'S BOLS MATZO**

5 lb. pkg.

**\$2.99**

**MOTHER'S ALL WHITE FISH**

24 oz. jar

**\$1.57**

GLASS MEMORIAL CANDLES	27¢
MOTHER'S BORSCHT	32 oz. jar 57¢
POWER'S FRUIT SLICES	8 oz. wt. pkg. 65¢
GOODMAN'S EGG MATZO	12 oz. wt. pkg. 79¢
GOODMAN'S MACAROONS	8 oz. wt. jar \$1.19
STREIT'S MATZO MEAL	32 oz. wt. pkg. \$1.39

**Food Club**

**WHIPPED TOPPING MIX**

4 oz. wt. box

**3/\$1**

**Food Club**

**MIXED VEGETABLES**

**Food Club**

**WHOLE OR SLICED POTATOES**

**Food Club**

**SLICED BEETS**

**GAYLORD**

**SWEET PEAS**

**GAYLORD**

**CREAM STYLE WHOLE KERNEL CORN**

16 to 17 oz. wt. can

MIX OR MATCH

**5/\$1**

SAVE UP TO 35% ON 5 CANS

**O & C FRENCH FRIED ONIONS**

3 oz. wt. can

**3/\$1**

PRICES GOOD MONDAY APRIL 5 THRU SATURDAY APRIL 10, 1976.

MEIJER RESERVES THE RIGHT TO LIMIT SALES ACCORDING TO SPECIFIED LIMITS.

NO SALES TO DEALERS, INSTITUTIONS OR DISTRIBUTORS.

**MEIJER**

• WELCOMES U.S.D.A. GOVERNMENT FOOD STAMPS  
• RESERVES THE RIGHT TO LIMIT TO REASONABLE QUANTITIES

SAVE UP TO 20%

Food Club

# 1% LOW FAT MILK

Gallon Jug

**79¢**

DEANS FRENCH ONION  
CHIP DIP

8 oz. wt. cup **25¢**

BAY  
ENGLISH MUFFINS

Plg. of 6 **3/\$1**

JENO FROZEN MULTI-PAK  
CHEESE OR SAUSAGE  
PIZZARINO

16-24 oz. wt. pkg. **97¢**

FRESH LIKE  
FROZEN CORN, PEAS, OR  
MIXED VEGETABLES

20 oz. wt. pkg. **48¢**

SAVE UP TO 27%

BANQUET (ALL EXCEPT HAM)

# FROZEN DINNERS

8-3/4 to 16 oz. wt. pkg.

**38¢**

Food Club

THROWN STUFFED  
MANZANILLA OLIVES

5 oz. wt. jar **63¢**

Food Club

PRUNE JUICE

40 fl. oz. bottle **57¢**

SHEDD SOFT WHIPPED  
MARGARINE

16 oz. wt. bowl **45¢**

LIGHT SPREAD QUARTERS  
CHIFFON

16 oz. wt. pkg. **29¢**

## WHY PAY MORE!

- PHILADELPHIA CREAM CHEESE . . . . . 8 oz. wt. pkg. **44¢**
- CASINO MOZZARELLA CHEESE . . . . . 12 oz. wt. pkg. **\$1.09**
- BORDEN LITE LINE SLICES . . . . . 12 oz. wt. pkg. **\$1.07**
- COSTELLO PKG. OF 5 LITTLE CHEESE PIZZAS . . . . . 12-1/2 oz. wt. pkg. **77¢**
- FOOD CLUB MIDGET LONGHORN CHEESE . . . . . 24 oz. wt. pkg. **\$1.99**
- FOOD CLUB INDIVIDUALLY WRAPPED SLICED AMERICAN . . . . . 8 oz. wt. pkg. **59¢**
- WIN SCHULERS BAR SCHEEZE . . . . . 16 oz. wt. refills **\$1.49**
- BIRDSEYE FROZEN AWAKE . . . . . 12 fl. oz. can **3/1**
- WEIGHT WATCHERS FROZEN VANILLA OR NEOPOLITAN DESSERT . . . . . 1/2 gal. ctn. **98¢**
- TOP FROST FROZEN FISH N' CHIPS . . . . . 16 oz. wt. pkg. **77¢**
- TOP FROST FROZEN COFFEE CREAMER . . . . . 32 fl. oz. ctn. **44¢**
- ELGIN FROZEN FLAV'R WHIP . . . . . 9 oz. wt. ctn. **43¢**
- BANQUET FROZEN CREAM PIES . . . . . 14 oz. wt. pie **44¢**
- BRADY FARMS FROZEN BLACKBERRIES OR DARK SWEET CHERRIES . . . . . 16 oz. wt. pkg. **66¢**
- KOEPPLINGER'S SUNNY HONEY BREAD . . . . . 16 oz. wt. (1 lb.) loaf **69¢**
- DUTCH GIRL APPLE BUTTER . . . . . 22 oz. wt. jar **59¢**
- LINDSAY MEDIUM PITTED RIPE OLIVES . . . . . 6 oz. wt. can **49¢**
- SALADA BLACK TEA BAGS . . . . . 100 count box **\$1.25**
- CRISCO SHORTENING . . . . . 48 oz. wt. can **\$1.38**
- 12 VARIETIES DUNCAN HINES CAKE MIX . . . . . 18-1/2 oz. wt. box **66¢**
- FOOD CLUB GROUND BLACK PEPPER . . . . . 2 oz. wt. can **29¢**
- BATH BAR SOAP 5¢ off label
- IRISH SPRING . . . . . 5 oz. wt. bar **27¢**
- LIQUID COLD WATER WASH WOOLITE . . . . . 16 fl. oz. bottle **\$1.19**

SAVE 45¢

# AJAX POWDERED LAUNDRY DETERGENT

15¢ off label 49 oz. wt. box

**89¢**

MUELLER'S  
LASAGNE

16 oz. wt. pkg. **49¢**

CHEF-BOY-AR-DEE  
SPAGHETTI SAUCE  
With Ground Beef

29 oz. wt. jar **79¢**

THANK YOU CHERRY  
PIE FILLING

32 oz. wt. can **79¢**

SAVE UP TO 61¢

DIET PEPSI OR PEPSI LIGHT OR

# PEPSI-COLA

8 pack 16 fl. oz. Non-returnable bottles

**\$1.28**

GOOD TASTE

SANDWICH COOKIES

DEVILS FOOD VANILLA DUPLEX PEANUT BUTTER . . . . . 12-1/2 oz. wt. pkg. **2/87¢**

NO GARLIC OR KOSHER  
AUNT JANE'S  
ICEBERG  
DILL SPEARS

24 fl. oz. jar **49¢**

REALEMON  
LEMON JUICE

16 fl. oz. bottle **37¢**

SAVE 59¢

GENERAL MILLS

# CHEERIOS

15 oz. wt. box

**29¢** WITH COUPON & \$20.00 PURCHASE

GAYLORD SALAD

DRESSING 32 fl. oz. (quart) jar **49¢**



COLE'S BAKERY

REG. \$1.09 - 14 oz. wt. pkg.  
WALNUT CARAMEL DANISH COFFEE CAKE **99¢**  
Plg. of 8  
HAMBURG BUNS **2/\$1**

**MEIJER** **59¢ COUPON**  
GENERAL MILLS  
**CHEERIOS**  
15 oz. wt. box **29¢**  
WITH COUPON & \$20.00 PURCHASE  
0000 4/5 THRU 4/10/76  
Coupon limited to one per family. DEPT. 417

**MEIJER** **30¢ COUPON**  
DUTCH TREAT  
**SUGAR WAFERS**  
12 oz. wt. box **39¢**  
WITH COUPON  
0000 4/5 THRU 4/10/76  
Coupon limited to one per item. DEPT. 419

**MEIJER** **20¢ COUPON**  
PRE-SOAKIN LAUNDRY DETERGENT  
**BIZ**  
38 oz. wt. box **\$1.39**  
WITH COUPON  
0000 4/5 THRU 4/10/76  
Coupon limited to one per item. DEPT. 410

**MEIJER** **50¢ COUPON**  
TOP CREST PREMIUM OR ECONOMY  
**BROOM**  
**50¢ OFF**  
WITH COUPON  
0000 4/5 THRU 4/10/76  
Coupon limited to one per family. DEPT. 410

**MEIJER**

PRICES GOOD MONDAY APRIL 5 THRU SATURDAY APRIL 10, 1976.

MEIJER RESERVES THE RIGHT TO LIMIT SALES ACCORDING TO SPECIFIED LIMITS.

NO SALES TO DEALERS, INSTITUTIONS OR DISTRIBUTORS.

**MEIJER THRIFTY ACRES — 45001 FORD RD. AT CANTON CENTER RD.**

SHOP MONDAY THRU SATURDAY 8 A.M. TO 10:30 P.M. — SUNDAY 9 A.M. TO 7 P.M.

Why Pay More! Why Pay More! Why Pay More! Why Pay More! Why Pay More! Why Pay More! Why Pay More!



**MEIJER**  
**FINEST**  
**USDA**  
**CHOICE**

SATISFACTION  
GUARANTEED  
OR  
Double Your  
Money Back

**MEIJER FINEST USDA CHOICE**

# ROUND STEAK

SAVE 80¢

REGULAR  
OR  
THIN SLICED

# 88¢

lb.

DUE TO THESE LOW PRICES ALL  
STEAKS AND ROASTS WILL BE  
SOLD AS STEAKS AND ROASTS  
ONLY.

**MEIJER**  
**FINEST**  
**USDA**  
**CHOICE**  
SATISFACTION  
GUARANTEED  
OR  
Double Your  
Money Back

**ROUND STEAK**  
**FOR SWISSING**  
SAVE 80¢ LB. **85¢** LB.

**BONELESS**  
**MEIJER**  
**FINEST**  
**USDA**  
**CHOICE**  
SATISFACTION  
GUARANTEED  
OR  
Double Your  
Money Back

**RUMP OR**  
**TIP ROAST**  
SAVE UP TO 50¢ LB. **\$1.18** LB.

**BONELESS**  
**MEIJER**  
**FINEST**  
**USDA**  
**CHOICE**  
SATISFACTION  
GUARANTEED  
OR  
Double Your  
Money Back

**HEEL**  
**ROAST**  
SAVE 70¢ LB. **88¢** LB.

**BONELESS**  
**MEIJER**  
**FINEST**  
**USDA**  
**CHOICE**  
SATISFACTION  
GUARANTEED  
OR  
Double Your  
Money Back

**TIP**  
**STEAK**  
SAVE 60¢ LB. **\$1.28** LB.

- FARMER PEET 1-1/2 lb. pkg. **\$2.29**
- REG. OR THICK SLICED BACON
- VENT SMOKED OR POLISH SAUSAGE 1 lb. **99¢**
- WHOLE RING BOLOGNA 1 lb. **88¢**
- 24 HOUR ALL WHITE MEAT TURKEY ROAST 2 lb. pkg. **\$3.29**
- ARMOUR WHITE & DARK MEAT TURKEY ROAST 2 lb. pkg. **\$2.89**
- ARMOUR TURKEY LOAF 2 lb. pkg. **\$1.89**
- ARMOUR SMOOKES 12 oz. wt. pkg. **89¢**
- ARMOUR CORN DOGS 1 lb. **99¢**
- ARMOUR PATTIES OR DRUMSTICKS BREADED VEAL 12 oz. wt. pkg. **89¢**
- ARMOUR VEAL STEAKS 12 oz. wt. pkg. **\$1.09**
- FOOD CLUB REG. OR THICK SLICED BOLOGNA 1 lb. **89¢**
- HERRUD BEEF EATER BEEF FRANKS 1 lb. **99¢**
- HERRUD LINK PORK SAUSAGE 12 oz. wt. pkg. **88¢**
- OSCAR MAYER SLICED BACON 1 lb. **\$1.88**
- ECKRICH REG. OR THICK SLICED BOLOGNA 1 lb. **\$1.49**
- ECKRICH BEEF FRANKS 1 lb. **\$1.19**
- PESCHKE FRESH BRATWURST OR POLISH SAUSAGE 1 lb. **\$1.39**
- OSCAR MAYER REG. OR BEEF SLICED BOLOGNA 8 oz. wt. pkg. **69¢**

**Food Club** OR **ARMOUR** ★

# CANNED HAMS

3 LB. **\$4.98** each      5 LB. **\$8.19** each

THORNAPPLE VALLEY SLICED  
**BACON** 12 OZ. WT. PKG. **\$1.28**  
20 OZ. WT. PKG. **\$1.98**

**Herrud** CHUNK JUMBO  
**BOLOGNA** **69¢** LB.  
SLICE YOUR OWN AND SAVE

**FALARSKI**  
**BOCKWURST** **\$1.19** LB.

ARMOUR ★  
12 OZ. WT. PKG. SLICED  
**BACON** **99¢** PKG.  
SAVE 46¢ PKG.

ARMOUR ★ **BONELESS**  
**HAM HALVES**  
**\$1.99** LB.

**Food Club** SKINLESS  
**FRANKS**  
SAVE 20¢  
12 OZ. WT. PKG. **59¢** PKG.

**MEIJER** **HERRUD** **40¢** COUPON  
**PARTY**  
**ASSORTMENT**  
**\$1.29** 1 LB.  
WITH COUPON  
GOOD 4/5 THRU 4/10/76  
Coupon limited to one per family. DEPT. 427

FROM THE SUNKIST PEOPLE  
CALIFORNIA SEEDLESS NAVAL  
**ORANGES**  
(72 SIZE) **10/68¢**

NEW CROP U.S. NO. 1 TEXAS  
**ONIONS**  
3 LB. BAG **44¢**

FRESH AND TENDER CALIFORNIA  
**BROCCOLI** **37¢** (18 SIZE)

NOTED FOR VITAMIN "A" WESTERN  
**CARROTS** 5 LB. BAG **58¢**

SALAD FAVORITE CHERRY  
**TOMATOES** **29¢** LB.

PRICES GOOD MONDAY APRIL 5 THRU SATURDAY APRIL 10, 1976.

MEIJER RESERVES THE RIGHT TO LIMIT SALES ACCORDING TO SPECIFIED LIMITS.

NO SALES TO DEALERS, INSTITUTIONS OR DISTRIBUTORS.

Top Fresh Top Fresh Top Fresh Top Fresh Top Fresh Top Fresh Top Fresh Top Fresh Top Fresh

Why Pay More! Why Pay More! Why Pay More! Why Pay More! Why Pay More! Why Pay More! Why Pay More!

Why Pay More! Why Pay More! Why Pay More! Why Pay More! Why Pay More! Why Pay More! Why Pay More!



# SUFFERING NEEDLESSLY?

Millions are turning to chiropractic because they have recognized the scientific principles of nature which have made spinal adjustments effective for many conditions where other methods have failed.

The chart below shows the lateral view of the spinal column and indicates in section "A," names of the spinal nerves as they branch from the spinal cord and exit through openings between the vertebrae. All tissues, glands and organs supplied with life energy by these nerves are shown in the section marked "B" in the chart. The section marked "C," describes a partial list of the conditions and symptoms that can result when there is an absence of life in the nerves.

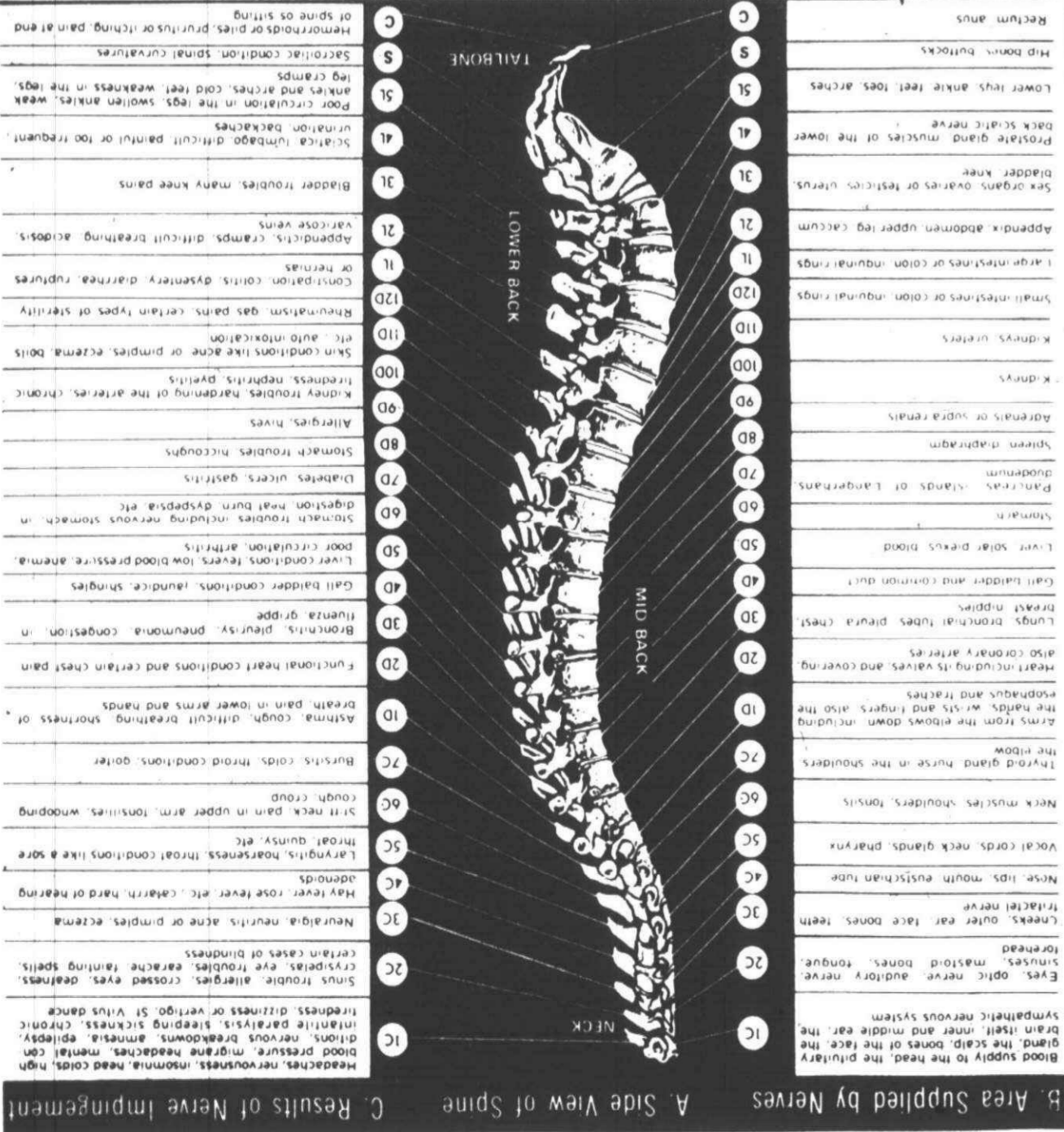

**SPINAL NERVE INVOLVEMENT CAUSES MANY CONDITIONS**

The spinal chart shown above is directed especially to those people who have tried to regain their health through methods other than chiropractic, and have failed. That failure should not lead to discouragement, but to greater determination to discover the fundamental cause of all disease.

Since the discovery of chiropractic, no one needs to feel that he or she is destined to be sick all their life. Remember, "Where there is life there is hope and he who has hope has everything."



...to pick up your phone and find out more about chiropractic health care. You've just read about people like yourself who, until a short time ago, were suffering and in the dark about what to do for their ailments. They found out. NOW'S THE TIME FOR YOU!

**CALL**  
**459-0200**

**GET YOUR APPOINTMENT EARLY!**

**WE ACCEPT ALL CASES REGARDLESS OF CONDITION OR FINANCIAL ABILITY TO PAY.**

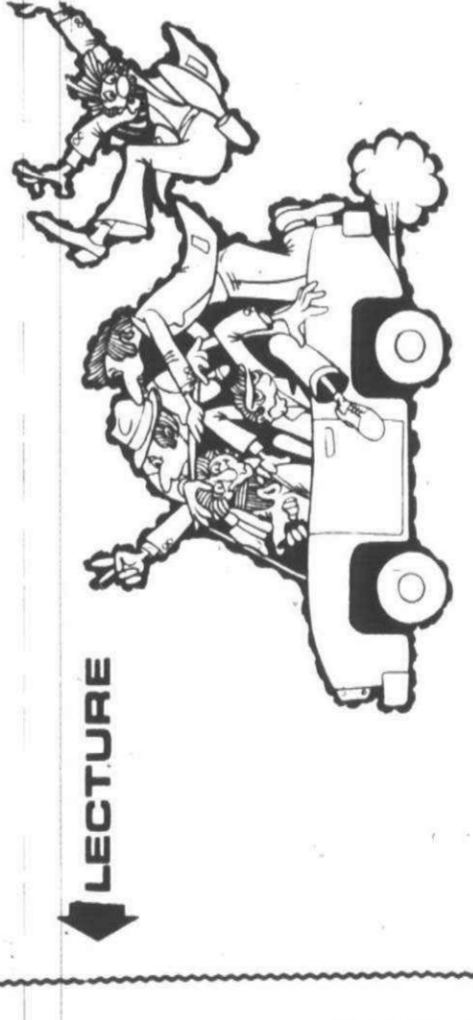

**LECTURE**

**Life Lectures are Held In Our Office Every Wednesday at 8:00 p.m.**

To further inform new and prospective patients of the benefits of chiropractic care, we offer a series of Life Lectures which are held every Wednesday evening at 8:00 p.m. The price of admission is a burning desire to live a healthy and happy life. You will hear today's health problems openly discussed, and there are question-and-answer sessions. Come and learn how chiropractic can correct the cause of your ailments. Regular scientific chiropractic health care can assure you of the best chances for continuing good health and radiant happiness. It is your birth-right!



**Health and Happiness from the Mashike Chiropractic Life Center**

**FAMILY HEALTH CARE**

Dr. Carlton R. Mashike—Chiropractor • 975 S. Main, Plymouth, Michigan 48170 • Phone 459-0200

**OFFICE HOURS: 9-12 and 3-8 Monday through Saturday**

# The Discovery Of A New World Of Health!



gaining the support of Isabella, the queen of Spain.

Equipped with ships, men and supplies, Columbus set sail for the New World. On Friday, October 12, 1492, came the long-awaited signal — "land ho!"

Another important discovery occurred in 1895, when Daniel David Palmer, after much research and studies, believed that sickness was simple and that within man himself was a simple cause for the malfunctioning of the body. He further reasoned that a cure could be brought about from within. Palmer was weary of people being drugged, poisoned, cut open and sewn up, only to be left worse in the majority of cases. He studied the human body as a machine, mechanically perfect when well mechanically imperfect when sick. His studies and ideas took shape on September 18, 1895, when he adjusted a displaced vertebra in the spine of a man who had been deaf for 17 years. The man's hearing was restored! This man, Harvey Lillard, who claimed that he had been so deaf that he could not hear a wagon on the street, now could hear the ticking of a watch!

Like Columbus, Palmer's idea was scorned and ridiculed by others until his drugless method of healing was proven. Today, his method is accepted almost universally, and is rapidly becoming the largest healing art in the world. This drugless health-restoring practice is known as CHIROPRACTIC.

A doctor of chiropractic concerns himself with the human spine because it is the foundation on which the remainder of the body is built, and it is the framework around which the body is constructed. But the spine serves yet another purpose. It protects the spinal cord through which vital nerve energy is channeled from the brain to all organs of the



Misalignments of the spinal column are the main cause of disease in the human body. Here, Dr. Mashike carefully checks the spine of one of his younger patients for dangerous misalignments before administering an adjustment.

The dictionary defines chiropractic as "a treatment for diseases based on hand manipulation of the spinal bones." However, this treatment should not be confused with the treatment afforded by medical practitioners who specialize in treating SYMPTOMS. By locating and removing spinal misalignments, chiropractors attack the CAUSE of sickness and disease in the human body.

It's time for you to do a little "exploring" for an alternative to pills, potions and injections. Call us today at 459-0200 for an appointment and begin to improve your health the natural way through chiropractic.

It may be the most important "discovery" that you'll ever make!



Chiropractic care is especially important during the formative years of children when their bones and tissues are still in the development stages. Dr. Mashike is shown here adjusting the spine of one of his many young patients.

# Chiropractic Patients

## 'Tell It Like It Is!'

### Mental Illness Overcome Through Chiropractic Care

Have you ever awakened from a nightmare, grateful that it was only a dream? Can you recall the relief that flooded your every nerve? The intense relaxation that followed?

Can you imagine living a nightmare for 23 years? Your worst imaginings cannot compare with reality. I can't remember all of the details, but some incidents are still with me. It all began while I was working at a factory. My arms began to hurt and get numb. I had severe pain in the back of my head and neck. It kept getting worse until one night I felt I would surely die. At midnight, my husband took me to a medical doctor.

The doctor said I had a nervous breakdown, and if I didn't improve by daylight, I would have to be hospitalized. Nerve medicine was given to me, but it didn't help. I refused to go to the hospital, and was getting worse. Then the doctor said I needed a D&C. I had the D&C and in six weeks I returned to the hospital for o-



HIPOCRATIC VISION RESTORATION

the awakening. A friend came to see me and asked my husband if he could take everyone's prayers. I went. I don't remember going in the door, but praise God, I remember coming out. My headaches are gone, and I no longer take nerve medicine. I'm enjoying my grandchildren. I didn't know what a chiropractor was—or what he did. I know now. If you feel you need help, see a chiropractor. I'm living a healthier life and chiropractic care was the answer for me.

**ASLEE COOK**

### Conditioning Your Spine for GOLF

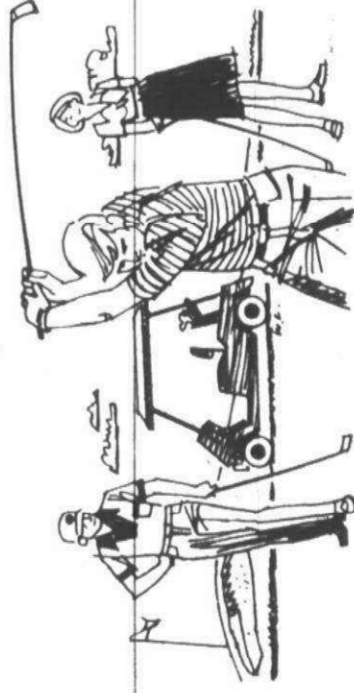

Every year, thousands of weekend golfers charge out to the golf course on the first nice day of the year and come home tired and aching. If you play golf, you should begin a conditioning program long before the start of the golf season. In addition to coordination and timing, the modern golf swing relies heavily on strong leg muscles and, to a lesser degree, muscles of the forearm, arm and shoulder.

Deep knee bends, perhaps later on in the program with

the addition of weights, helps the legs. The hip raiser is good. To do this, lie flat on your back with knees bent. Arch your hips upward as high as possible and hold for five seconds, then return to the starting position.

The back face is also helpful. Stand with your arms folded in front at shoulder level with your legs shoulder-width apart. Turn to your right so that you are looking behind you. Return to the starting position and make a similar turn to the left.

Before beginning any exercises, have a chiropractic

### Pacemaker Not Necessary, Thanks to Chiropractic

In February, 1975, my husband John and I went to see a chiropractor. John had suffered for more than a month—his chest pains, backaches, insomnia and palpitations after meals were too much to bear.

When we reached the doctor's office we were greeted by the friendliest doctor you will ever chance to meet. He looked at John's chest and readily saw that John was in agony. His breastbones were protruding. An x-ray was taken and the first adjustment was administered. It wasn't easy for John to relax after bearing these pains for so long, but he did rest better after the first adjustment.

Two days later, the doctor showed us John's x-ray and explained it thoroughly. We were amazed to see two bad curvatures and a twisted pelvic area, among other things. The doctor said it was the worst curvature he had ever seen. Many adjustments were necessary to correct the spine.



After a few adjustments, all the aches and pains subsided. John can rest better, he feels better and is more active. I, too, had an x-ray taken and was given my first adjustment.

In June, 1974, I was hospitalized, attended by three physicians. The diagnosis—hypertension, cardio-vascular involvement. The heart specialist informed my husband and me of the possibility of a pacemaker. I was put on medication with the thought that should the medicine fail to work effectively, the pacemaker would be next. I discussed this with the chiropractor and he assured me that chiropractic adjustments would help regulate the nerves to the heart.

After the first few adjustments I began to feel new life. A surge of energy has come to me and I'm confident that, with more adjustments, I will be off medication, as I'm taking less now. My husband and I now have weekly adjustments and a real humanitarian. We only wish we had visited the chiropractor sooner, for now we have a new lease on life! We are both healthier and happier, thanks to chiropractic care.

**DOROTHY WINGARD**

### Kidney Trouble Gone!

Several years ago I started passing small amounts of blood in my urine. From then on for many years, I had trouble with my kidneys. I tried many remedies, but without results. My general health began to fail and my strength was getting less and less until I passed out. My wife became frantic and called a chiropractor to see if he could help me. I was rushed into his office for emergency chiropractic care. After the first adjustment, I walked out of his office on my own and have been doing great ever since. No more kidney problems!

The chiropractor's examination found the cause of my condition to be the second vertebrae in my neck pinching the spinal cord. This was hard to believe because there didn't seem to be any pain in my neck. But, I guess the proof is in the results.

**EDWARD GATES**

### Editor's Note

These testimonials do not mean to infer that chiropractic cures or guarantees a cure. They are to prove that, by removing nerve interference, the body heals itself.

### "MD's Said There Was No Hope For Me"

been able to, I believe I would have taken my own life.

A neighbor tried to get me to go to a chiropractor, but I refused. What could a chiropractor do for me? I had been to an MD and there was no hope for me.

This condition continued until one day my neighbor came over and said she had lost her patience with me. She "took the bull by the horns" and began giving orders. She said she had seen enough of this and was almost angry with me for being so obstinate. She was very firm and told me to get dressed because she was taking me to her chiropractor.

From then on, my whole life changed. I was able to go back to work and live a normal life. I can dance, swim and do all the things I



In August, 1949, I was in an accident which left me with a bad whiplash. The pain became so bad that I was helpless... I had to be helped in and out of bed, screaming with pain. My poor children had to stand by and watch me suffer. I wanted to die and, had I

### Pneumonia Victim Regains Health

In January of 1975 I was taken sick. My medical doctor said I had pneumonia. He put me in the hospital for five days, gave me some shots and finally dismissed me. He said he had done all that he could do for me. I just laid in bed, couldn't eat and vomited all the time. I got so weak I couldn't turn over in bed or walk up the stairs without help.

A dear friend of mine had been insisting that I go to her chiropractor. I wouldn't give in, but in February I thought I was dying so my



friend took me to her chiropractor. After just seven adjustments I feel fine, I have gained five pounds, can eat anything and am no longer sick to my stomach. I am so thankful, but I only wish I had gone sooner to a chiropractor. Regardless of what is wrong with you, please try chiropractic.

I am telling everyone I meet how wonderful I feel. My friends who don't see me every day can't believe how well I look.

**LEORA CHIPMAN**

### Entire Family Reaps Benefits from Chiropractic

Before I started chiropractic care I was really in bad shape. For the last 10 years I have been in and out of hospitals and constantly on medication. I hurt all over and felt so run down that I would have to force myself to do anything. As something, I tried chiropractic care after everything else failed. I thank and praise God for opening my

I have had very good results with chiropractic and I am going to continue having regular check-ups for the rest of my life because I know that I will then maintain good health. My whole family is now under chiropractic care. I have a great deal to be thankful for—thanks to chiropractic.

**MRS. MARLYS BUHR**

### ALL INSURANCE COVERAGE

- including BLUE SHIELD
- MEDICAID (A.D.C. WELFARE)
- WORKMAN'S COMPENSATION
- MEDICARE

### Vertebral Subluxation

Everybody, including babies, can have these dangerous subluxations, or misalignments, in their spine. Unless these "silent killers" are located and corrected by a chiropractor, sickness and disease will develop.

How do you get them? Any accident, however minor it may seem, can cause the bones of the spine to shift, putting pressure on delicate nerve trunks. Sudden twists, jars, jerks and even simple nervous tension can distort the spine. If you fall, you may experience pain in some part of your body due to a bruise or cut, and the impact of hitting the ground causes the spine to become misaligned. The visible injuries will vanish in time, but the misalignment remains and you may experience symptoms elsewhere in the body, such as headaches, dizziness, etc. The longer the misalignment goes undetected, the more serious your condition will become, and the longer it will take to obtain results through chiropractic.

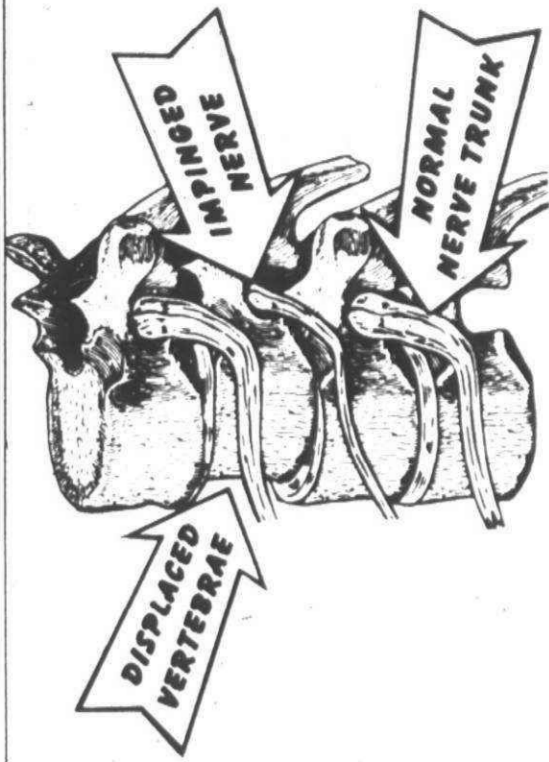

### Questions And Answers

By DR. CARLTON R. MASHKE

#### WHY SHOULD I BECOME A CHIROPRACTIC PATIENT?

Through scientific research and clinical observation chiropractors have learned that slight displacement of vertebrae causes pressure on nerves, and interferes with vital nerve energy, resulting in disharmony and disease in the body. No other health system is so specific or acts in such perfect harmony with nature's healing power. Chiropractors are trained to locate and correct the cause of disease.

#### ARE CHIROPRACTIC ADJUSTMENTS PAINFUL?

NO... Gentle spinal adjustments are painless. Chiropractors are specially trained to locate and correct displacements in the vertebrae with little or no discomfort. After spinal displacements are corrected the body will feel more active, giving you that healthy, happy feeling.

#### HOW LONG DO I HAVE TO STAY UNDER CHIROPRACTIC CARE?

You must come in regularly until your spine holds its proper alignment and nerve pressure is relieved. Once this is achieved, your chiropractor will reduce your visits according to your needs. Your chiropractor is the best judge of how often you should be examined. For the quickest and best results, his instructions must be followed.

#### HOW LONG WILL IT TAKE TO OBTAIN RESULTS?

In a short period of time you will begin to feel relief. Some conditions, however, may not respond as rapidly as others because these conditions have been developing over a long period of years.

Once the vertebrae has been adjusted, freeing vital nerve energy to all parts of the body, the process of recovery comes quickly and naturally.

#### DO CHILDREN RESPOND TO CHIROPRACTIC?

Children usually respond to chiropractic adjustments more readily than adults. Their little bodies are growing, the tissues are rapidly developing and can be changed from a state of sickness to a state of health quite easily.

Children love chiropractic adjustments because they are gentle and painless and the doctor does not require them to take harsh tasting remedies, nor does he stick them with needles. Chronic diseases usually begin in early childhood and develop over a long period of time. The best way to prevent chronic diseased organs and tissues is to remove the underlying basic fundamental cause of nerve interference in early childhood.

#### MY PHYSICIAN SAYS MY CONDITION IS "JUST NERVES." CAN CHIROPRACTIC HELP NERVES?

Yes. It is popular to label conditions that do not respond to medication as "just nerves." It's shameful to deny people relief through chiropractic care because of deliberate prejudice. Everyone should receive regular chiropractic check-ups to stay healthy.

#### MY LITTLE GIRL HAS ASTHMA AND ALLERGIES. CAN CHIROPRACTIC HELP HER?

Yes. Asthma and allergies respond beautifully under chiropractic care. When spinal nerves are pinched, vital energy is lacking and "symptoms" appear. Gently spinal adjustments restore vital life to the body by unblocking essential nerves and allowing it to come back to health.